

HARVARD MEDICAL
LIBRARY



RÖNTGEN

THE LLOYD E. HAWES
COLLECTION IN THE
HISTORY OF RADIOLOGY

☞ Harvard Medical Library
in the Francis A. Countway
Library of Medicine ~ Boston

VERITATEM PER MEDICINAM QUÆRAMUS



Digitized by the Internet Archive
in 2011 with funding from
Open Knowledge Commons and Harvard Medical School

HIGH-FREQUENCY CURRENTS

HIGH-FREQUENCY CURRENTS

BY

FREDERICK FINCH STRONG, M.D.

Instructor in Electro-Therapeutics at Tuft's College
Medical School, Boston.

WITH 183 ILLUSTRATIONS IN THE TEXT



NEW YORK
REBMAN COMPANY
1123 BROADWAY

COPYRIGHT, 1908, BY
REBMAN COMPANY
NEW YORK

Entered at Stationers' Hall, London, England, 1908

All rights reserved

Printed in America

PREFACE

IN all ages of which we have any authentic knowledge, and among all races, there have existed Philosophers, Investigators or Students of the Occult, who have in divers forms, and many languages, repeatedly averred that the Universe—both visible and invisible—exemplified varied expressions of a single principle—VIBRATION. During the last two centuries we have abandoned the theoretical and hypothetical science of the Ancients, and have gradually built up a coherent fabric by logical deductions from actual study of the facts and phenomena of the objective world. Up to a few decades ago, the various truths postulated by science had not fully conformed to a condition of “harmonious correlated Unity,” which theoretically should be the case according to *Herbert Spencer*. The Chemical Elements were apparently distinct, unalterable, and bore no mathematical relation to each other. Seventy or more varieties of solid indivisible atoms formed the basis of the material universe, and behind these was a hypothetical “Ether” of absolutely unknown nature. *Matter* was called “dead,” or “living,” according to the reflected phenomena, and an apparently boundless gulf existed between the two. Science was becoming more and more complex when the advance guards of a new era appeared, headed by *Clerk Maxwell* with his “Electro-magnetic Theory of Light,” and *Mendelejeff* with his “Periodic Law of the Elements,” and rapidly followed by *Crookes*, *Tesla*, *Curie*, *Becquerel*, *Hertz* and *J. J. Thompson*, whose labors and researches have focused in the greatest discovery of any age—THE ELECTRON THEORY. Although recent and revolutionary, this hypothesis has met with instant and eager acceptance on the part of the leading scientists throughout the world. In the bright light which it throws on the phenomena of the universe, much that was dark and undefined has become lucid and coher-

ent. All sciences have become united by invisible links, and we have for the first time in the history of the world a complete, harmonious system of natural philosophy, by which all facts of nature, however diverse, may be co-related and traced to a common origin. And the crowning postulate of this wonderful new system is identical with the most ancient theory of the universe which history records. In other words science informs us that all natural phenomena result from VIBRATION in a medium of a primitive nature, which appears to be nothing more nor less than *Electricity*. All forms of Force, from the attraction of the Sun for the Earth to the vital phenomena of the Human Organism, are fundamentally *Electrical Vibrations*.

The "*High-frequency Currents*" are Electrical Vibrations artificially produced, which bear a certain relation to the currents which traverse the nerves in the maintenance of life in the human body. Being *Vibrations*, rather than *flowing streams* of Electrical particles, the High-frequency Currents penetrate glass as readily as a sound wave would traverse a plate of metal, and pass through the human organism without producing the slightest sensation.

The discovery and application of High-frequency Currents has resulted mainly from the work of two American Scientists, *Tesla* and *Elihu Thomson*. *Tesla* first recognized the wonderful *therapeutic* possibilities of High-frequency Currents and prophesied that they would ultimately supersede the older systems based upon the therapeutic use of Drugs; clinical results recorded during the past five years go far to confirm the accuracy of *Tesla's* prophecy.

Although a greater part of the literature of High-frequency Therapeutics ascribes the development of these currents for the treatment of disease to *d'Arsonval* and *Oudin*, it is a fact of record that the subject was developed independently by the present writer on distinctly different lines. Whereas *d'Arsonval's* work was solely with *Low Potential Currents*, while *Oudin's* High-potential effects were of *Mono-polar* character and therefore limited to the treatment of local conditions—the writer from the very first employed the *Bipolar High-potential Currents* of *Tesla*, and it is due to this fact that the System of Tech-

nic developed by him for the therapeutic application of *Tesla* Currents possesses so much wider a field of usefulness and produces so many more distinct physiological effects than the methods developed by *Oudin* and *d'Arsonval*. For the past decade the writer has been continuously engaged in a clinical and laboratory study of the various types of High-frequency Currents; hundreds of cases have been treated, and many important facts recorded, which are given to the profession for the first time in the present volume.

At the request of a number of his colleagues the present writer has not only gone into minute details in connection with the physical laws and methods of using the various apparatus herein described, but has compiled a concise Elementary Text-book containing the *Essentials* of the entire subject of Electrotherapeutics. This little book, which is a pocket-edition, should be carefully studied as a preliminary introduction to the present volume.

In conclusion, the writer desires to acknowledge his indebtedness for the help which he has obtained from the works of *Freund*, *Belot*, *Guilleminot* and *Chisholm Williams*. He also extends his hearty thanks for the collaboration and valuable assistance accorded him by *Dr. H. G. Piffard*, *Professor Elihu Thomson*, *Dr. J. P. Sutherland* and *Professor Northrop*. Valuable clinical information has been received from a number of physicians, for which due acknowledgment will be made in the Treatise on the Therapeutic results of High-frequency Treatment, which the writer purposes to compile during the next two years, as a more or less necessary sequel or complement to the present volume.

TABLE OF CONTENTS

CHAPTER I

	PAGE
HISTORICAL AND INTRODUCTION	1

CHAPTER II

ELECTRONS AND VIBRATION	18
<i>Table of Waves of Radiant Energy</i>	<i>24</i>

CHAPTER III

ELECTRO-PHYSICS, FROM THE STANDPOINT OF THE ELECTRON	
THEORY	30
<i>Magnetism</i>	<i>33</i>

CHAPTER IV

ELECTRO-PHYSICS (<i>continued</i>)	
<i>The Nature and Generation of Alternating Currents</i>	<i>36</i>

CHAPTER V

PHYSICAL FACTORS INVOLVED IN THE GENERATION OF HIGH-FREQUENCY CURRENTS	46
--	----

CHAPTER VI

EUROPEAN TYPES OF HIGH-FREQUENCY APPARATUS	58
--	----

CHAPTER VII

THE DEVELOPMENT OF AMERICAN HIGH-FREQUENCY THERAPEUTICS	
<i>Earlier Forms of Alternating Current Apparatus</i>	<i>88</i>

	PAGE
CHAPTER VIII	
MODERN HIGH-FREQUENCY APPARATUS OF THE AMERICAN TYPE	
<i>Tesla-Thomson Coils</i>	106
CHAPTER IX	
MODERN AMERICAN HIGH-FREQUENCY APPARATUS, FOR "DIRECT CURRENT" USE	114
CHAPTER X	
ANALYSIS AND COMPARISON OF HIGH-FREQUENCY CURRENTS OF DIFFERENT FORMS OF APPARATUS	124
CHAPTER XI	
THE PHENOMENA AND PHYSICAL PROPERTIES OF HIGH- FREQUENCY CURRENTS	132
(A) <i>Phenomena of Induction</i>	133
(B) <i>Electro-Static Phenomena</i>	135
(C) <i>Electro-Dynamic Phenomena</i>	142
(D) <i>Resonance Effects</i>	146
CHAPTER XII	
THE MEASUREMENT OF HIGH-FREQUENCY CURRENTS	149
CHAPTER XIII	
TECHNIC FOR THE THERAPEUTIC APPLICATION OF HIGH- FREQUENCY CURRENTS	155
CHAPTER XIV	
THERAPEUTIC TECHNIC (<i>continued</i>)	
<i>The Resonator Discharge</i>	161
CHAPTER XV	
THERAPEUTIC TECHNIC (<i>continued</i>)	
<i>Methods for the Application of Tesla Currents</i>	166

CHAPTER XVI

	PAGE
THERAPEUTIC TECHNIC (<i>continued</i>)	
<i>Treatment by Means of Glass "Vacuum Electrodes"</i>	175
(A) <i>Monopolar Direct Application</i>	185
(B) <i>Monopolar Indirect Application</i>	186
(C) <i>Bipolar Direct Application</i>	186
(D) <i>Bipolar Multi-Frequency Treatment</i>	187

CHAPTER XVII

THE HIGH-FREQUENCY CURRENT FOR THE PRODUCTION OF THE X-RAY	190
---	-----

CHAPTER XVIII

THE GENERATION OF THE ULTRA-VIOLET RAY BY HIGH- FREQUENCY CURRENTS	201
---	-----

CHAPTER XIX

THE GENERATION OF OZONE BY THE HIGH-FREQUENCY CURRENT	205
--	-----

CHAPTER XX

A REVIEW OF MODERN THERAPEUTIC METHODS	209
--	-----

CHAPTER XXI

PHYSIOLOGICAL ACTION OF OSCILLATORY CURRENTS	216
--	-----

CHAPTER XXII

THE THERAPEUTIC ACTION OF HIGH-FREQUENCY CURRENTS	226
(A) <i>D'Arsonval Currents</i>	227
(B) <i>Currents of Very High Potential with Relatively Low Amperage</i>	229
1. <i>Monopolar Treatment</i>	230
2. <i>Bipolar Application or Tesla Technic</i>	238
3. <i>Multi-Frequency Modalities</i>	242
4. <i>Hyperstatic Technic</i>	247

CHAPTER XXIII

	PAGE
HIGH-FREQUENCY CURRENTS IN THE TREATMENT OF DISEASES OF NUTRITION	249
(A) <i>Diseases of the Digestive System</i>	250
(B) <i>Diseases of the Blood and Heart</i>	253
(C) <i>Diseases of the Respiratory Tract</i>	255
<i>Pulmonary Tuberculosis</i>	257
(D) <i>Diseases Involving Deranged Metabolism</i>	268
(E) <i>Diseases of the Excretory Apparatus</i>	270

CHAPTER XXIV

THE TREATMENT OF DISEASES OF THE NERVOUS SYSTEM BY HIGH-FREQUENCY CURRENTS	272
---	-----

CHAPTER XXV

INFECTIOUS AND MALIGNANT DISEASES	275
---	-----

CHAPTER XXVI

SPECIAL USES FOR CURRENTS OF HIGH FREQUENCY	280
INDEX	285

LIST OF ILLUSTRATIONS

FIGURE	PAGE
1. Arrangement of Leyden Jars for Producing Alternating Currents of Great Frequency. (D'Arsonval-Hertz.) .	5
2. D'Arsonval Auto-Conduction Cage; Upright Form. (Piffard's.)	6
3. D'Arsonval Auto-Condensation Couch. (Williams.) .	7
4. Miniature Tesla Apparatus. (E. Ducretet.)	7
5. Diagram of Oudin-D'Arsonval High-frequency Apparatus	8
6. Small "Tesla," or "Secondary" Coil for Use with Primary Solenoid	8
7. D'Arsonval Bipolar High-tension Coil. (Williams.) .	9
8. Diagram of Solenoid and Resonator. (Freund.) . . .	10
9. Oudin Resonator. (Williams.)	11
10. Bipolar Resonator of O'Farril	11
11. Rochefort's Bipolar Resonator. (Guilleminot.) . .	11
12. Piffard's "Hyperstatic Transformer"	12
13. The Author's Air-gap Condenser Terminals	16
14. A System of Technic for the Therapeutic Use of High-frequency Currents	17
15. Schematic Diagram Showing Spontaneous Degeneration of Atoms	22
16. Magnetism Induced in Iron Bar by Current in Coil of Wire	33
17. Diagram Indicating Wave Length and Frequency of Known Forms of Radiant Energy	35
18. Hydraulic Analogue of "Continuous Current" Circuit .	36
19. Hydraulic Analogue of "Alternating Current" Circuit .	37
20. "Graphic Tracing" of Alternating (Sinusoidal) Current	37
21. Magnetic-electric Induction. (Williams.)	40
22. Diagram of Simple "Magneto", Generating an Alternating Current	40
23. } Leyden Jar, or Condenser	43
24. }	

FIGURE	PAGE
25. Plate Condenser with Inductance Coil and Discharging Circuit	44
26. Diagram Showing Analogy Between Falling Water and a Current of Electricity. (Williams.)	47
27. Plate I. D'Arsonval Circuit and Hydraulic Analogue	48
27. Plate II. Tesla-Thomson Circuit and Hydraulic Analogue	49
28. Bursting and Re-formation of Elastic Skin on Boiling Molasses	51
29. Bursting and Re-formation of Elastic Skin on Boiling Molasses	51
30. Sir Oliver Lodge's Hydraulic Analogue	54
31. Electrolytic Interrupter of Wehnelt. (Williams.)	58
32. Noden Valve, or Rectifier. (Williams.)	59
33. Ruhmkorff Induction Coil. (Watson, London.)	60
34. Ruhmkorff Induction Coil, Shown Diagrammatically. (Williams.)	61
35. Mercury Jet Interrupter. (Isenthal & Co.)	62
36. Dipper Mercury Interrupter	63
37. Mackenzie-Davidson Interrupter	63
38. Wehnelt Interrupter. (Williams.)	64
39. Oudin-Dean Resonator. (Williams.)	65
40. Resonator of Lebailly and O'Farril	67
41. Rochefort's Bipolar Resonator. (Freund.)	67
42. Upright Solenoid on Cabinet. (Williams.)	68
43. Isenthal-Oudin Resonator	69
44. Gaiffe's Oil Condenser and Heavy Solenoid	71
45. Gaiffe's Bipolar Resonator	72
46. Condenser. (From Belot.)	73
47. Liquid Resistances. (From Belot.)	74
48. Arrangement of Valves, Tube and Meter. (From Belot.)	75
49. Transformer. (From Belot.)	76
50. General Diagram. (From Belot.)	77
51. Top Shelf of Cabinet. (From Belot.)	78
52. Lower Shelf of Cabinet. (From Belot.)	78
53. Springs and Contact Plate. (From Belot.)	79
54. Regulating Apparatus Arrangement of Transformer. (From Belot.)	80
55. Isenthal's Complete High-frequency Apparatus. (Williams.)	81

FIGURE	PAGE
56. Resonator and Condensers (small model). (Williams.)	82
57. Diagram of the Author's Original Type of High-frequency Apparatus; "The Strong-Ovington Coil"	83
58. "The Knott" High-frequency Coil, Working Part Immersed in Oil	84
59. Diagram of the Author's Apparatus, Adapted for the Generation of Heavy D'Arsonval Currents, as well as those of the High-potential ("Tesla") Type	85
60. Kinraide Coil; Alternating Type	88
61. Diagram of Kinraide Coil Showing Relation of Spirals	89
62. Tesla-Thomson High-frequency Apparatus	90
63. Piffard's "Hyperstatic Transformer"	92
64. Brown High-frequency Coil	94
65. Campbell High-frequency Coil	95
66. Kinraide Coil with Improved Spark-gap	96
67. Cyclone Coil. (Portable form.)	98
68. Spark-gap of Jackson's Coil	102
69. High-frequency Spark-gap	102
70. The Author's "Special Hercules" Coil	103
71. Jackson Coil with Separate Secondaries	104
72. The Author's "Ajax Coil"	107
73. The "Ajax Special Coil"	108
74. Theater Plug	109
75. The Author's New Graduated Spark-gap, for Ajax Coils	110
76. The Author's "Hercules" High-frequency Apparatus	111
77. The Author's Improved Rotary Spark-gap	112
78. Rotary Converter, Excited by a 110-Volt Direct Current, and Generating an Alternating Current of 80 Volts	115
79. Scheidel-Western Coil for Exciting High-frequency Apparatus	116
80. "Scheidel-Western" High-frequency Apparatus	117
81. "Inducto-resonator" Involving Induction, as well as Resonance	117
82. "Meyrowitz" High-frequency Apparatus	118
83. The "Cole Coil" for X-Ray and High-frequency Generation	119
84. The Hercules "Universal"	121
85. The Author's Improved Electrolytic Interrupter	122
86. The High-frequency Discharge	125

FIGURE	PAGE
87. Graphic Tracings of High-frequency Currents	125
88. Arrangement for the Production of Oudin-D'Arsonval Currents	126
89. Arrangement for the Production of Tesla-Thomson Cur- rents	127
90. Graphic Representations of Various Currents	128
91. Lamp Lighted by the Current "Backed Up" by the Impedance of the Heavy Copper Arch Attached to the D'Arsonval Solenoid	134
92. Incandescent Lamps lit by Currents Induced in Closed Circuits	134
93. Geissler Tube Illuminated on the "Electrical Aura" or "Vibratory Field" Surrounding a Patient, con- nected to a Terminal of a Tesla Coil	135
94. Beautiful Effluve from the Points of a Skeleton Star	136
95. Illuminated Sign, Formed by the Effluve Given from a Fine Wire	137
96. Terminals of the Author's Apparatus Arranged to Show the "Arc" Discharge	137
97. Primary Condenser Discharges per Second	138
98. Appearance of Rapidly Revolving Narrow Geissler Tube Connected to Terminal of "Ajax Coil"	139
99. "Pseudo-Static Spark" from the Author's Hercules Machine	140
100. Resonator Discharge from Terminal of Tesla Coil	142
101. Flow of a High-frequency Current Through a Wire to an Insulated Metal Plate	144
102. The Author's Apparatus for Demonstrating the Elec- tro-dynamic Phenomena of High-frequency Currents	145
103. Autograph of a Pair of Artery Forceps Laid Upon a Sensitive Plate	147
104. Hot Wire Milliamperemeter for Measuring the Inten- sity or Volume of Currents of High-frequency	150
105. Lamp Bulb Hand-Electrode	151
106. The Author's Photometric Mil-ammeter	152
107. Professor Flemming's Direct Reading Cymometer." (Marconi Wireless Telegraph Co.)	153
108. Direct Treatment by Current from D'Arsonval Sole- noid Applied to Patient, Through Sponge-covered Electrodes	156

FIGURE	PAGE
109. Auto-conduction Cage—Horizontal Form	156
110. Piffard's Improved Auto-Conduction Cage. Vertical Form	157
111. Small Cages for Treatment of Arm, Leg, etc.	158
112. Condenser Couch. (Williams.)	158
113. Piffard's "Cushion Spiral"	159
114. Piffard's "Condenser Chair"	160
115. Effluve Electrodes	163
116. "High-frequency Cautery"	164
117. Tesla-Effluve	168
118. "Pseudo-static Spark" Treatment	169
119. High-frequency "Motor-Wave Current"	170
120. The Author's Mechanism for Superimposing a Low- frequency, Sinusoidal Wave Upon a Tesla Current	171
121. High-frequency Motor-Impulse Current. (Pseudo- Faradic.)	172
122. Theoretical Tracing of Current Obtained by the Use of the Author's Mechanical Device	173
123. Theoretical Tracing of Current Obtained by the Use of the Author's Mechanical Device	173
124. The Author's Technic for Vacuum Electrodes. "Tesla Vacuum Treatment"	176
125. Doctor Snow's set of Vacuum Electrodes	180
126. Double-walled Vacuum Electrodes	181
127. The Author's Technic for the Use of Glass Condenser Electrodes	182
128. The Author's Regulating Handle for Vacuum or Con- denser Electrodes	182
129. Herschell's Regulating Handle and Rectal Electrode. (Williams.)	182
130. Ebonite Spinal Electrode. (Williams.)	183
131. Condenser Electrode; "Low Red Vacuum Type"	184
132. Vacuum Condenser Electrode with Cupping Device	184
133. Monopolar Direct Technic	185
134. Monopolar Indirect Technic	185
135. Bipolar Direct Application of Vacuum Electrodes	186
136. Friedländer's Vacuum Condenser Chair	187
137. The Author's set of Condenser Electrodes	188
138. Method of Taking a "Skiagraph"	193
139. X-Ray Tube with Solid Metal Anode	194

FIGURE	PAGE
140. "Water-cooled" X-Ray tube	194
141. Vacuum Regulators for X-Ray Tubes	195
142. Self-regulating X-Ray Tube	196
143. Types of "High-frequency X-Ray Tubes"	197
144. Thomson Double Focus X-Ray Tube	198
145. Single Focus Tube for H. F. Currents; with Hollow Metal Cone Under Anode	198
146. Single Focus Tube for H. F. Currents (Double Bulb Type)	199
147. Latest X-Ray Tube for Either Direct or Alternating Currents	200
148. Diagram of Finsen's Arc Lamp. (Guilleminot.)	201
149. Piffard's Spark-gap Lamp	202
150. Strong's Ultra-violet Lamp for Use with "Ajax" or "Hercules" Coils	202
151. Strong's Apparatus for the Treatment of Pulmonary Tuberculosis	206
152. Apparatus for Generating Galvanic and Faradic Currents from Battery Cells or Edison 110-Volt "Direct" Circuit.	217
153. Diagram of Static Electrification	218
154. "Static Breeze." (Diagram.)	218
155. Diagram of Static Spark Treatment	219
156. Diagram of Static Induced Current	219
157. Diagram of Static Wave Current	220
158. D'Arsonval Auto-conduction Cage Operated from the Author's "Hercules" Coil	228
159. Diagram of "Labile" Method for Solenoid Currents	228
160. Sponge-covered Electrodes for "Labile D'Arsonvaliza- tion"	229
161. Piffard's Small Spiral with Condensers; for Use with Ruhmkorff Coil	230
162. Vacuum Electrode Covered with Chamois Skin	233
163. Ultra-violet Vacuum Lamp with Quartz Lens	234
164. Indirect Vacuum Treatment	235
165. Rhythmic Effluve Treatment for General Stimulation	239
166. "Motor Impulse" Treatment	240
167. The Author's Technic for Vacuum Electrodes	240
168. The Author's Treatment for Diseases of the Uterus	241
169. Double Vacuum Treatment	242

FIGURE	PAGE
170. Double Effluviation from the Author's Apparatus	242
171. European Outfit for Double Effluviation, by Means of Two Resonators	243
172. The Author's "Condenser Effluve" Treatment	244
173. Tracing Giving a Conventional Idea of the Nature of the Author's High-frequency Wave Current	245
174. Graphic Tracing Giving Theoretical Idea of the Au- thor's Motor Impulse Current	246
175. Graphic Tracing Giving Theoretical Idea of "Pseudo- faradic" Current	246
176. Piffard's Technic for his "Trans-resonator Effluve"	247
177. Piffard's Electrode for Obtaining his "Trans-resonator Effluve"	247
178. Diagram of the Author's Treatment for Diseases of the Intestinal Canal	251
179. The Author's Treatment for Chronic Constipation and for Chronic Cólitis	252
180. Tubulated Vacuum Electrode for Inhalation Treat- ment	257
181. The Author's Portable High-frequency Apparatus Operated by Current from its Own Battery	276
182. The Author's Localizing Effluve Electrode for Treat- ing Ulcers and Septic Areas	277
183. Vacuum Electrodes for Treatment of Pyrrhoea Alveo- laris	282

HIGH-FREQUENCY CURRENTS



HIGH-FREQUENCY CURRENTS

CHAPTER I

HISTORICAL AND INTRODUCTORY

THE gradual waning and ultimate extinction of the vital spark at the close of a long and healthy life must be regarded as a phenomenon quite as natural as that of birth, but we must admit that at the present day a great majority of the deaths are abnormal and premature, resulting from the adverse influences of disease and unhygienic environment. That the race will ultimately reach a stage of advancement in which physical health will be the rule and death by disease a rare event, we have reason to hope and believe from the results of hygienic education and public sanitation which have been introduced during the past few decades and which have already greatly increased the average length of life. The study of pathology and bacteriology has resulted in Antitoxic methods for the prevention of many formidable diseases. Surgery has become a science through the same means, while the advent of Antitoxic serum marks the first *strictly scientific use* of a chemical substance as a curative agent. Almost all the drugs of the *Materia Medica* have been used in a more or less empirical manner. The study of the fundamental processes of cell action and vital chemistry has resulted in a more rational selection and preparation of food and has evolved the modern science of Dietetics. Finally, after exhausting all the resources of complex indirect methods of treatment, the medical profession have begun to study the therapeutic action of the fundamental forces of nature.

Prior to the last decade, physical therapeutic agents comprising the X-Ray, Ultra Violet Ray, Light and Sound Waves, Mechanical Vibration, Scientific Nerve Massage and the various

forms of electricity were used in a desultory and unscientific manner, being absolutely ignored by a large majority of the profession. It was the advent of the *Roentgen* Ray which formed the entering wedge for the introduction of physical methods into therapeutics by bringing the physician into touch and familiarizing him with apparatus for the generation of electricity of much higher potential than formerly used in electro-therapeutics. A physician using a Static machine for X-Ray purposes would naturally desire to know the technic whereby the various currents obtainable from his apparatus could be applied to therapeutics. Similarly at the present time, the purchaser of a *Ruhmkorff* Coil for radiography naturally investigates the methods of *d'Arsonval* and *Oudin*, of which he can avail himself at a small expense by the addition of a "Resonator" to his coil. The modern High-frequency apparatus of the Tesla-Thomson type, as employed by the present writer, has been an important factor in the development of physical therapeutics, although designed originally for radiographic use.

Prior to *Roentgen's* discovery, the use of electricity as a therapeutic agent, was confined to the employment of Faradism and Galvanism by a very small percentage of the profession, the currents being as a rule seldom used except as adjuvants to some older and more conventional method of treatment. A few enthusiastic specialists, however, carried on investigations in electro-physiology and pathology and laid the foundation of our modern scientific use of electricity for the treatment of disease.

The Induction Coil, invented by *Faraday* in 1831, was greatly improved as a therapeutic agent by *Dubois-Reymond*, *Triplier*, and *Apostoli*. The convenience of the Faradic battery, its portability, and the wonder and mystery that surrounded it in the eyes of illiterate persons, led to its adoption by many quacks and irregular practitioners, whose extravagant and unwarranted claims resulted in the ostracism of electro-therapeutics by many of the more conservative members of the profession.

Galvani's discovery (in 1790) of the response of a frog's muscle to electrical stimulation, supplemented by *Volta's* development of the "Voltaic Pile" (in 1800), gave us the *Galvanic Current*,

which has been scientifically developed into a valuable therapeutic agent by *Remak*, *Rockwell*, *Apostoli*, and others.

Its principal value lies in its power to dissolve cicatricial and redundant tissues and to drive remedial agents directly into the body. The Static Machine, which was originally employed for therapeutic purposes by *Benjamin Franklin*, had reached a very perfect stage of development when *Roentgen's* discovery was given to the world. In 1881 *Dr. Wm. James Morton* of New York published a report describing a new substitute for the Faradic Current, derived from the Static Machine by the use of *Leyden Jars*, in series with the patient. This "*Static Induced Current*," although in reality not of an oscillatory nature, was the prototype of our modern High-frequency Currents, and is of interest inasmuch as it marks the first use of condenser discharges in the treatment of disease. The discharge of the *Leyden Jar* or Condenser (invented in 1775 by *Professor Musschenbroek*) was studied in 1842 by *Professor Henry* of this country, who demonstrated its oscillatory nature. In 1847 *Von Helmholtz* made a similar statement, which was definitely proven by the experiments of *Doctor Feddersen* of Denmark in 1850 by the use of the rotating mirror. The spark from the Jar was in this manner shown to consist of a series of oscillations, whose period was estimated at not less than one one-millionth of a second. In 1886, *Professor Heinrich Hertz* published his epoch-making discovery of *Electrical Waves*, which was supplemented by the work of *Sir Oliver Lodge* in 1887. *Hertz's* "Resonator" consisted of two polished metal spheres on the outer end of two metal rods, which terminated in small brass balls separated by a gap of fifteen millimeters. The rods were connected with the terminals of an induction coil, and the sparks between the small spheres were found to set up radiating *Electrical Waves*, capable of inducing sparks across a minute break in a brass wire circle suspended near the coil. The size of the circle and wire had to be very carefully determined, as the waves caused no sparks unless the circle was "tuned" to respond to a vibration of the same frequency as that of the waves. This apparatus forms the basis of modern Wireless Telegraphy as well as our apparatus for the production of High-frequency Currents.

The peculiar physiological properties of alternating currents of High-frequency were noticed some years prior to the discovery of their remarkable physical peculiarities. In experimenting with the great *Spotteswoode* Coil, *Ward*, in 1879, found that when a frequency of 8,000 interruptions per second was attained, accidental shocks were much less severe than with a lower rate of interruption. *Rowland*, some years later found that High-frequency Currents obtained from the *Leyden* Jar discharge could be passed through the body with little discomfort. While *Joubert*, in 1889, found that a nerve-muscle preparation from a frog's leg did not respond to a rapid oscillatory current. The development of High-frequency Currents from a physical standpoint has resulted mainly from the independent investigations of two American scientists—*Prof. Elihu Thomson* and *Nicola Tesla*. In a lecture before the Royal Society of Engineers in 1891, *Tesla* demonstrated his wonderful discoveries in High-frequency Currents by a series of brilliant experiments. This lecture has been published in book form and was for many years the only obtainable work on this subject. At the World's Fair in 1893, *Prof. Elihu Thomson* exhibited his giant High-frequency Coil which produced a flaming arc of over six feet in length. Up to within a few years this was by far, the largest induction coil in the world. Despite its tremendous power, the current from this coil could be passed through the body with but little discomfort. The therapeutic development of High-frequency Currents generated in accordance with the methods of *Tesla* and *Thomson* has been almost exclusively the work of the present writer and was begun in 1895. In 1893, *Professor d'Arsonval* of Paris published a report of his experiments with High-frequency currents obtained from the apparatus of *Hertz* and *Sir Oliver Lodge*. He had been engaged for some years in studying the physiological effects of Sinusoidal Currents of high and low frequencies, and had noticed that the phenomenon of muscular excitation decreased progressively as the frequency was increased. His experiments are reviewed in detail in a succeeding chapter. He first used the apparatus of *Hertz*, 1891, obtaining a current of considerable strength and a frequency so high that their passage through the body was attended

with no sensation whatever. The apparatus which he employed is illustrated diagrammatically in Fig. 1. The *Leyden Jars* (A-A') are connected to the terminals of a powerful Static Machine or *Ruhmkorff* Coil; their outer coatings (B-B') are connected to the ends of a coil of heavy copper wire (C-C'). The number of turns in this coil depend upon the size and capacity of the *Leyden Jars*, in other words, the *inductance* of the coil must be *attuned* to the *capacity* of the Jars or *Condensers*. (See chapter on Physics.) This produces electrical *resonance* between the Jars and the Coil, so that when a spark passes between A and A', several hundreds of thousands of electrical oscillations

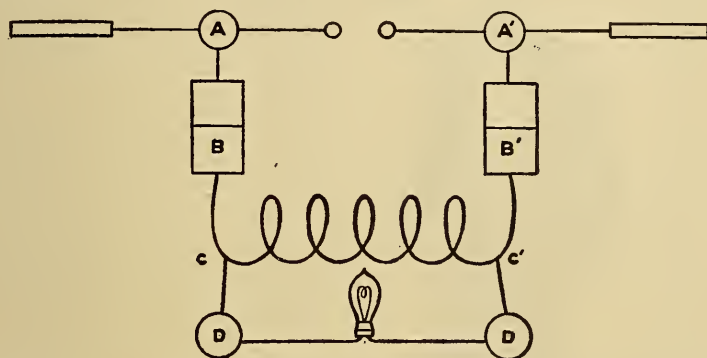

FIG. 1.—Arrangement of Leyden Jars for Producing Alternating Currents of Great Frequency. (D'Arsonval-Hertz.)

will pass through the coil. By connecting a wire to the terminals (C-C') of the coil (which is called the "*Solenoid of d'Arsonval*"), these oscillations can be conducted to an external circuit. When the latter is formed of two persons (D-D') holding between them an incandescent bulb, L, the High-frequency Currents formed by succeeding groups of electrical oscillations, will light the lamp to its full candle power. *D'Arsonval* states that he has been able to pass through his body currents of more than three amperes. *Prof. Elihu Thomson* has passed through his body without injury a current four or five times this amount. If the frequency of the above currents had been fifty, or a hundred, instead of from five hundred thousand, to a million per second, fatal results would have been instantly produced. The theories which have been advanced to account for the apparent

immunity of the animal body to powerful Currents of High-Frequency will be fully discussed in the chapter on physiology. *D'Arsonval* observed that painless Currents of High-Frequency could be induced in the human body without actual electrical

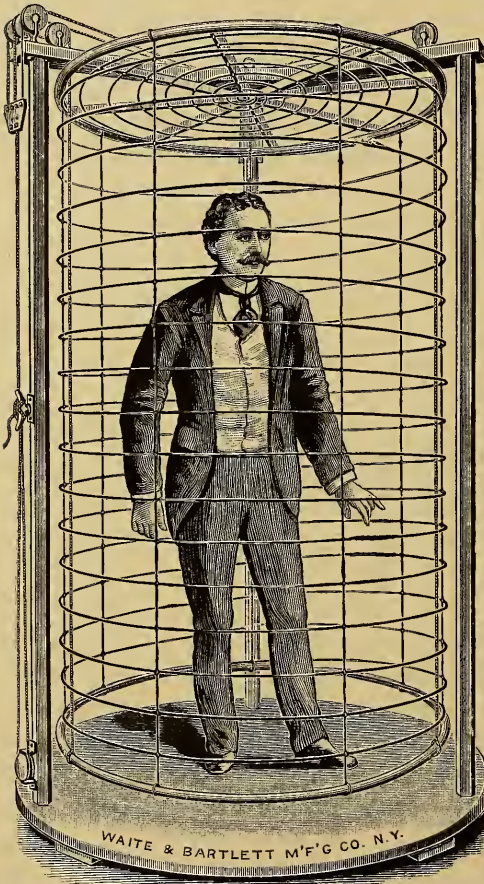

FIG. 2.—D'Arsonval Auto-Conduction Cage; Upright Form. (Piffard's.)

contact. In place of the Small Solenoid, he substituted a large spiral of heavy wire wound upon a cylindrical wooden framework, forming a cage in which the patient stood or reclined. (See Fig. 2.) This apparatus is used in Therapeutics under the name of the "Auto-conduction Cage of *d'Arsonval*." Another method devised by *d'Arsonval* for the application of these currents is known as "Auto-condensation." The patient is connected to one end of the Small Solenoid by a metal hand electrode, the other end of the solenoid being attached to a large sheet of

thin metal placed upon the couch upon which the patient reclines; a thick cushion covered with heavy sheet rubber is interposed between the plate and the patient, and may be regarded as analogous to the insulating glass of a *Leyden Jar*, the inner and outer coatings of which are represented respectively by the metal plate and the body of the patient. (See

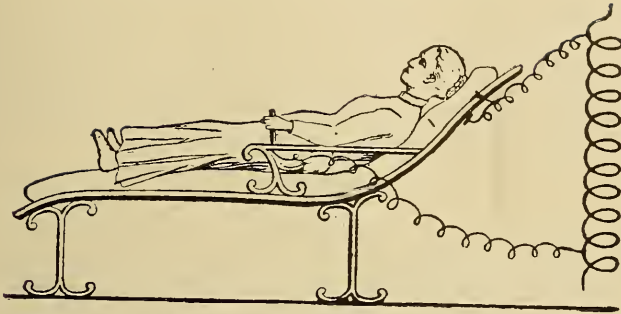

FIG. 3.—D'Arsonval Auto-Condensation Couch. (Williams.)

Fig. 3.) The currents obtained from the various forms of *d'Arsonval* Solenoid, while of High-Frequency and large amperage, are of relatively low voltage, and their Therapeutic effects are general rather than local. The wonderfully brilliant Electrostatic effects obtained by *Tesla* with his alternating currents of High-Frequency and High Potential led *d'Arsonval* and his colleagues to study them therapeutically. *Tesla's* original High-frequency apparatus being too large and expensive, a miniature form of his outfit was employed, which was made by *Ducretet*

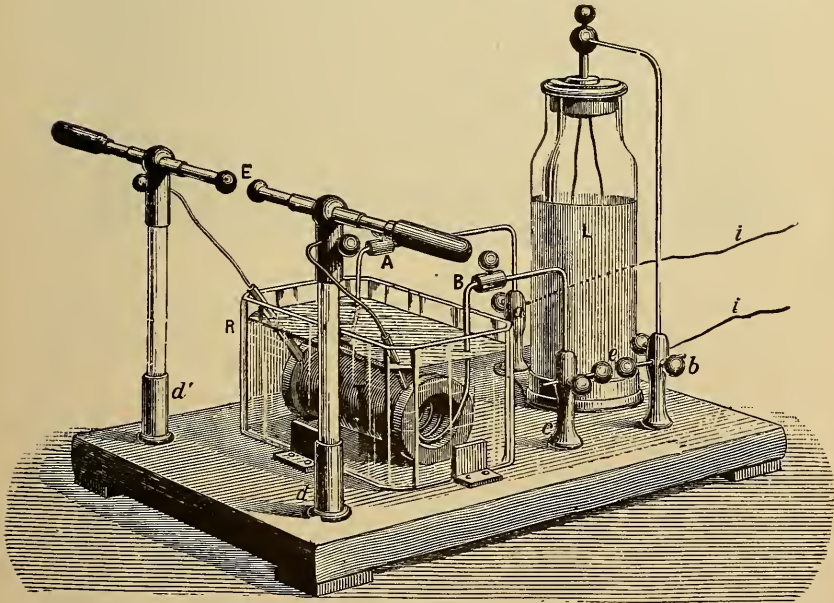

FIG. 4.—Miniature Tesla Apparatus. (E. Ducretet.)

of Paris (See Fig. 4). A current from the *Ruhmkorff* Coil was connected by the wires (i-i) to the inner and outer coatings of a *Leyden Jar*; in a discharging circuit, consisting of a coarse wire coil (A-B) in series with a short spark-gap (e),

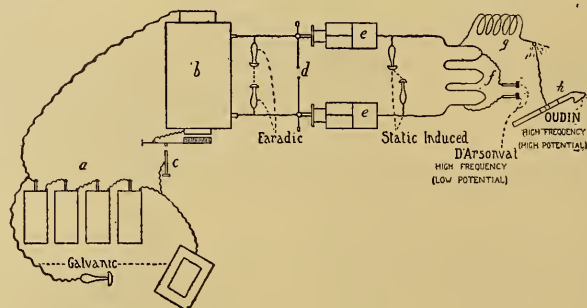

FIG. 5.—Diagram of Oudin-D'Arsonval High-Frequency Apparatus, Showing Intermediate Forms of Current.

a, Batteries in "Series." *b*, Induction Coil. *c*, Vibrator or Interrupter. *d*, Spark-gap. *e*, Condensers for Leyden Jars. *f*, D'Arsonval "Solenoid." *g*, Oudin "Resonator." *h*, "Vacuum Electrode.

the oscillations from the condenser induced in a fine wire secondary coil (F), a High-frequency Current of High Potential, which discharged in the form of a flaming arc between the insulated terminals at (E). The two coils are concentric and are immersed in a bath of oil for insulation. Another type of apparatus used in *d'Arsonval's* original experiments is indicated diagrammatically in Fig. 5. A *Tesla* Coil can be used with this outfit consisting of a reel wound with very fine wire contained in a glass tube filled with oil; (See Fig. 6). By

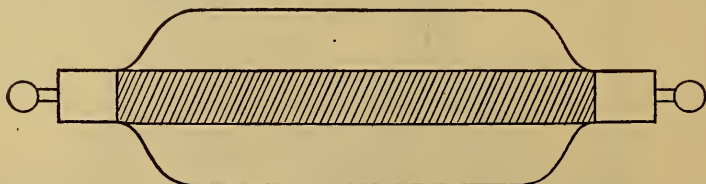

FIG. 6.—Small "Tesla," or "Secondary" Coil, for Use with Primary Solenoid. (See Fig. 5.)

slipping this tube inside the small Solenoid, the latter is made to act as the *primary coil* of a High-tension Transformer, the *secondary* or *Tesla Coil* being enclosed in a glass tube. A more practical form of this device is known as "*d'Arsonval's*

High-tension Coil," (See Fig. 7), which is in reality a High-frequency Transformer of the *Tesla-Thomson* type, air being used for insulating purposes instead of oil. At the present time these devices are seldom used among European specialists, their High-potential, High-frequency Currents being generally derived from what is known as "*Oudin's Resonator*"; (See Fig. 9).

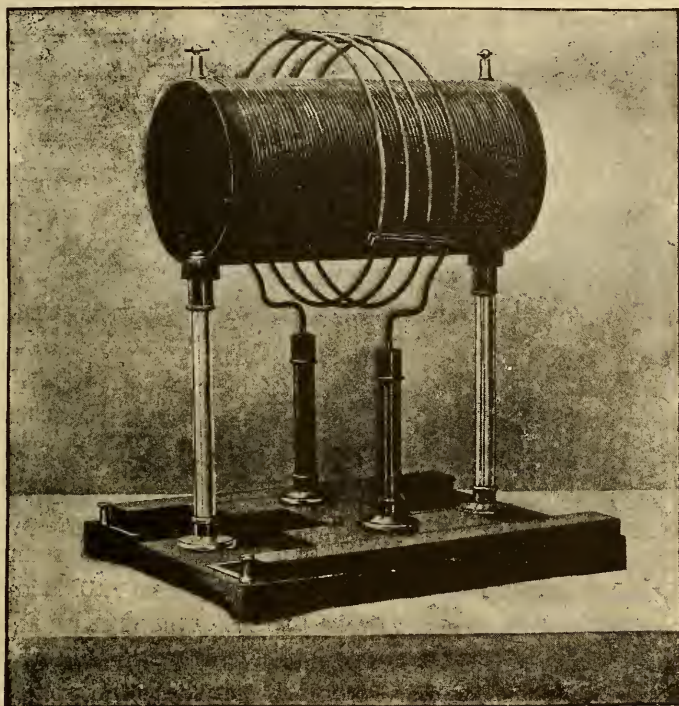

FIG. 7.—D'Arsonval Bipolar High-tension Coil. (Williams.)

This device consists of a large fiber cylinder or tube, having a number of turns of fine insulated wire wound on a spiral upon its outer surface. The lower end of this wire is connected to the Small Solenoid of *d'Arsonval*. As a rule the latter is incorporated in the resonator and consists of fifteen or twenty turns of course copper wire wound upon the lower part of the cylinder, as in Fig. 9, the upper end of the solenoid being continuous with the lower end of the Resonator Coil. (See Fig. 8). It is necessary that a certain inductive relation exist between the solenoid

and Resonator Coils; they must be *attuned*, or in *resonance*. This tuning is usually accomplished by cutting out one or more turns of the Solenoid by means of a movable contact. (Fig. 9).

To the upper end of the Resonator Coil is attached a wire which is connected to an insulated metallic electrode, which is

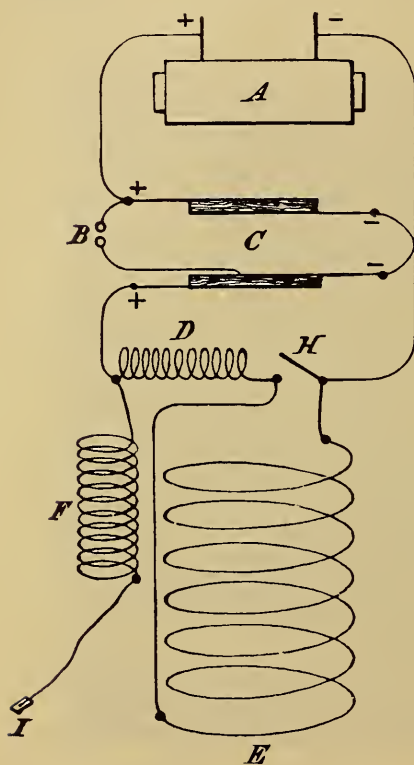

FIG. 8.—Diagram of Solenoid and Resonator. (Freund.)

used for applying the “Ef-fluve,” or High-frequency Brush Discharge to the body of the patient. This discharge is essentially of a monopolar character and is therefore limited to the treatment of local conditions. To obtain an actual High-frequency, High-potential Current for general as well as local effects, it is necessary to employ a generator of the *Tesla-Thomson* type. In Europe, however, these effects are usually obtained from a Bipolar Resonator, two forms of which are shown diagrammatically in Figs. 10 and 11. Resonators and Solenoids require a large *Ruhmkorff* Coil for their successful operation. The current from Static Machines was regarded as of too small amperage for high-

frequency purposes. In 1900, however, *Dr. H. G. Piffard* of New York devised a small apparatus of the *Tesla* type for obtaining High-frequency effects from a Static Machine. Although the current obtained from this apparatus was of small quantity, its potential and frequency were very high, making it especially suitable for the treatment of diseases of the skin. This is known as the “Hyperstatic Transformer,” and is quite generally employed in series with the Static Machine in this

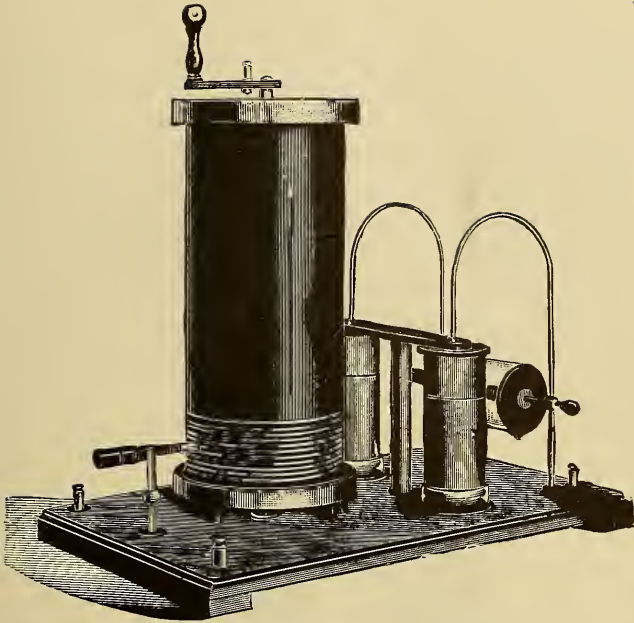

FIG. 9.—Oudin Resonator. (Williams.)

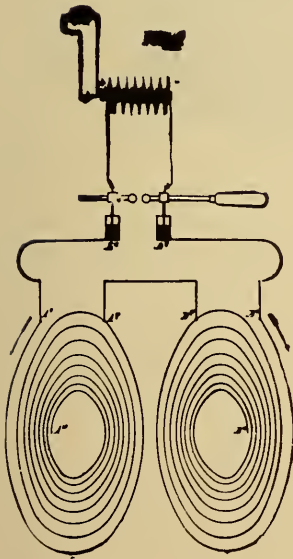

Fig. 10.—Bipolar Resonator of O'Farril.

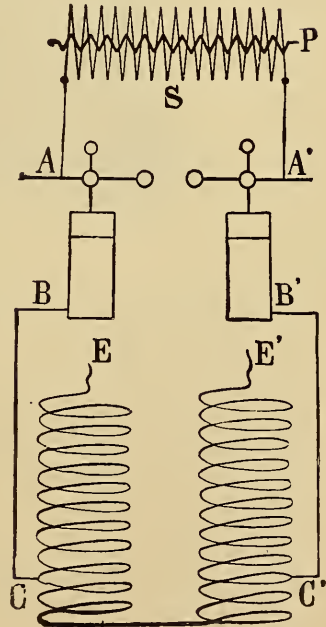

FIG. 11.—Rochefort's Bipolar Resonator. (Guilleminot.)

country. (See Fig. 12). *Piffard* also demonstrated the possibility of obtaining efficient *d'Arsonval* Currents from powerful Static machines of the modern American type, and devised several instruments for the generation of these Currents.

The study of High-frequency Currents of the *Tesla-Thomson* type in relation to therapeutics, was undertaken by the author in 1896. During the first few years of his work, he believed himself to be the pioneer in this particular field of investigation, and when he finally learned of the work of *d'Arsonval*,

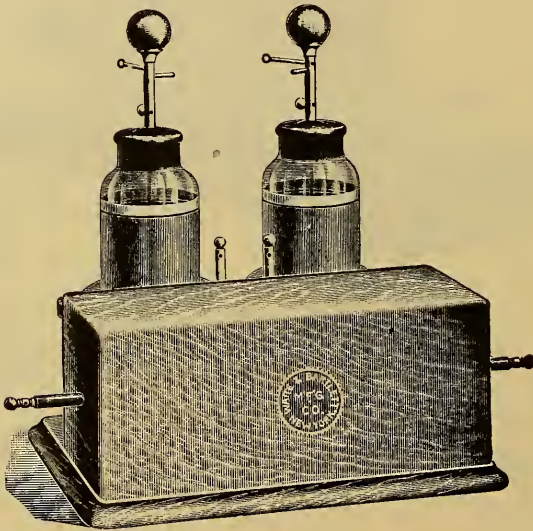

FIG. 12.—Piffard's "Hyperstatic Transformer."

he had independently developed a complete system of technic for the clinical application of Electrical Oscillations; had determined the relative value and peculiarity of action of currents of different frequencies, and had founded at the Boston Dispensary, through the courtesy of *Dr. Frederick Coggeshall*, what was undoubtedly the first "High-frequency Clinic" in America. Despite the crudity of his home-made apparatus, the writer satisfactorily demonstrated the undoubted therapeutic value of High-frequency Currents in a great variety of diseased conditions, much of the work being done at the above-mentioned Clinic.

A magazine article by *Tesla*, published in 1893, gave the writer his first idea of the nature and therapeutic possibilities of High-frequency Currents. *Tesla* reported his observations of the stimulating and vitalizing action of these Currents in the cases of several of his assistants, and upon his own organism. Although disclaiming any belief in the therapeutic value of the older forms of electricity then in use (Faradism, Galvanism, etc.), he professed himself as fully convinced of the important part that his High-frequency Currents of High Potential were destined to play in the Healing Art of the future. These facts were not considered at the time, as of more than passing interest, but were brought back to the writer's memory a few years later in a lecture on the X-Ray at the Massachusetts Institute of Technology, in which the methods for the generation of High-frequency Currents were explained, and demonstrated by a small coil of the *Thomson* type excited by the discharge of a battery of *Leyden Jars* charged by a *Ruhmkorff* Coil. There was at this time practically no literature on the subject, except a report of *Tesla's* lecture before the Royal Society of Electrical Engineers, in 1891.

Through the courtesy of *Dr. J. B. Sutherland*, at that time Professor of Anatomy at Boston University School of Medicine, the writer was given the use of his private laboratory for the purpose of carrying out investigations concerning *Roentgen's* newly discovered "X-Rays." His first work was done with a small three-inch spark coil, laboriously wound by hand, and a small *Crookes* tube obtained from *Queen & Co.* A few weeks' experience demonstrated the inadequacy of this apparatus for X-Ray work, and the construction of an eight-inch coil was under way when the above lecture was given at the Institute of Technology. This was the real beginning of the writer's investigations of High-frequency Currents, and his first "*Tesla* Coil" was completed simultaneously with his eight-inch *Ruhmkorff*. When primary batteries were used as a source of energy he found that the X-Rays from the latter coil were superior to those obtained from "the *Tesla*" and the latter was temporarily discarded for X-Ray work.

About this time the writer made the acquaintance of *Mr.*

T. B. Kinraide and witnessed at his laboratory in Jamaica Plain, a demonstration of X-Rays of such power as to render the bones of the trunk as clearly visible as those of the hand. Without doubt, *Mr. Kinraide* was the first investigator to produce rays of such high power, but his methods were so expensive and complicated as to greatly restrict the field of their application. A tremendous amperage was obtained from a large bank of storage cells, the current being interrupted by a heavy Platinum Break of *Mr. Kinraide's* invention. A *Ruhmkorff* coil, rated at about eight inches, was thus operated, the secondary terminals being connected with a condenser immersed in kerosene. This in turn was provided with a discharge circuit, consisting of a *Tesla-Thomson* Coil (immersed in oil), in series with a spark-gap. From the secondary of the High-frequency Coil, *Mr. Kinraide* derived the currents which he employed to excite his *Crookes* tube. Some months later he invented his well-known "*Kinraide* Coil," which superseded his original apparatus. At the suggestion of *Mr. Kinraide* the writer modified his own outfit, and adapted it for use on the 104 volt, 60 cycle, alternating, Electric Light Current, obtaining results far beyond his expectations. The only unsatisfactory feature of this apparatus was the spark-gap, which consisted of two electric light carbons mounted on an insulated support, and separated by a short air space. An air blast spark-gap, as suggested by *Prof. Elihu Thomson* increased the steadiness and efficiency of the discharge, but greatly complicated the apparatus. At this period, the *Knott* Apparatus Company, of Boston, brought out their "*Knott* High-frequency and X-Ray Apparatus," which was provided with a simple rotary spark-gap, consisting of a large metal disk, revolving in front of a brass ball. This device, we believe, was the invention of *Mr. E. Cate* of the *Knott* Company. The writer's rotary gap, employed in the "*Hercules*" Coil, is an improved and perfected form of *Mr. Cate's* device. The *Knott* Coil, which is described in an ensuing chapter, was the first American High-frequency apparatus placed on the market, and for years was the only successful coil of this kind in use for X-Ray work. With the addition of the *Knott* spark-gap, the writer's apparatus proved very satisfactory, and was subse-

quently employed by him almost daily in X-Ray and therapeutic work. The marked relief of pain experienced by several rheumatic patients after undergoing examinations by the X-Ray, revived in the mind of the writer the statements of *Tesla*, regarding the therapeutic value of High-frequency Currents, and led to experiments which proved that it was the *electricity*, and not the *X-Ray*, which allayed the pain, thus demonstrating the correctness of *Tesla's* theory.

From that time to the present, the writer has studied to perfect apparatus for the efficient production of *Therapeutic High-frequency Currents*, the generation of X-Rays being regarded as of secondary importance. From the first, the writer administered the treatment by connecting the patient to the terminal of his *Tesla* Coil by means of a metal hand-electrode, the opposite pole being connected with the various devices for causing the discharge to play upon the affected area of the patient's body. A few accidents, in which the electrode was carried too near the body (causing a painful spark), led to the employment of a tube of glass between the patient and the active electrode. It was but a step to substitute for the glass-covered metal electrode, a *Geissler* Vacuum Tube, in which the current passes through the body via the glass walls of the tube and the rarefied gas which it contains. This led to the invention of the *Vacuum Electrode*, a device now universally employed, but which was first devised by the writer in 1897.

In 1898 the writer devised his well-known "Air Gap Condenser Terminals," shown in Fig. 13, which illustrates the first form of the writer's High-frequency Apparatus that was introduced to the Medical Profession. By the use of these terminals, in connection with the writer's Bipolar, High-frequency, High-potential Apparatus, a number of entirely new and distinct effects were obtained. In this way, the therapeutic action of Faradic, Pulsatory and Sinusoidal Currents of Low Frequency was added to the general and local effects of the High-frequency *Tesla* Currents. Ultimately a number of distinct methods, or "Modalities," were evolved, and in 1903, at the request of a number of physicians who were using the writer's apparatus, he published his results in the form of a small treatise entitled

"A System of Technique for the Therapeutic Use of High-frequency Currents." A chart giving a graphic outline of each of the methods described, was incorporated in the above treatise. (See Fig. 14.) About this time the writer designed his Portable Apparatus and his large "Grand Model" High-frequency Apparatus, styled by its manufacturers the "*Hercules Coil*." During the past year a simplified, less elaborate form of this apparatus has been placed on the market, being known as the "*Ajax Coil*." This apparatus has met with the approval of a large number of

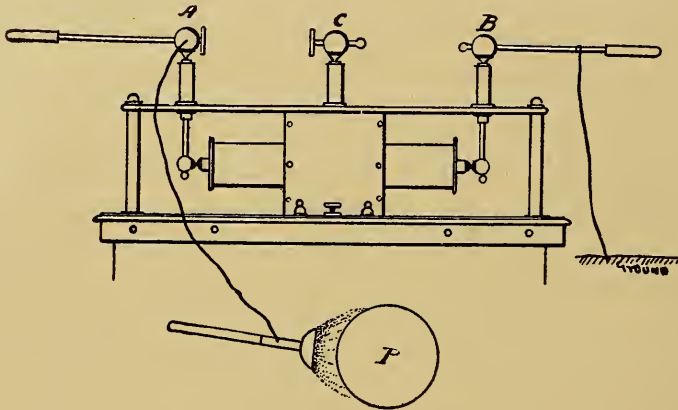

FIG. 13.—The Author's Air-gap Condenser Terminals.

physicians, and is in general use in various parts of the country. The writer's latest apparatus is known as the "*Hercules Universal*," inasmuch as it combines in a single apparatus, the devices of *Tesla*, *d'Arsonval* and *Oudin*, and is provided with a large *Ruhmkorff* Coil for heavy X-Ray work.

When the X-Ray was first employed therapeutically, in the treatment of cutaneous diseases, the writer made a comparative study of the Static Machine, *Ruhmkorff* Coil, and his own *Tesla* Apparatus, and found that the X-Rays obtained from the latter possessed many advantages therapeutically over those generated from the other machines. Since that time he has devised a number of types of Vacuum Electrodes for combined treatment by the *Tesla* High-frequency Currents and X-Rays, as well as with Ultra Violet Rays, and other types of radiant energy. A complete description of the nature and use of these devices, as

well as the details of a number of types of High-frequency machines of different design and manufacture, will be given in the ensuing chapters.

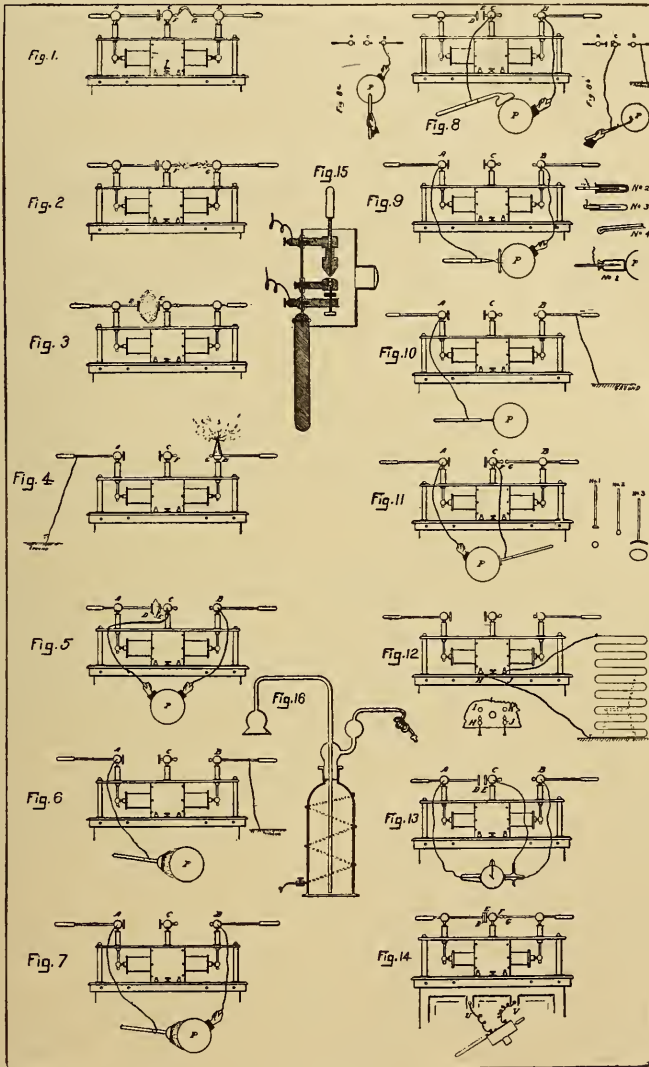

FIG. 14.

CHAPTER II

ELECTRONS AND VIBRATION

ALL our conceptions of the external world are derived through impressions conveyed by the nerves corresponding to our five senses. These impressions are the result of vibratory forces which impinge upon the nerve ends. Difference in sensation results from the varying rate of the vibrations and from the character of the medium through which the vibrant waves travel. For example—*Sound* is the result of mechanically excited waves transmitted through the air or some solid or liquid substance; at about 40,000 vibrations per second sound waves become inaudible, as our auditory keyboard has a limited number of notes.

We explain all natural phenomena by means of two fundamental conceptions called *Matter* and *Force*. *Matter*, we define as that which occupies space or takes up room. *Force or Energy* is that which produces a change in the form, nature or position of matter. We assume that all forms of matter are composed of collections of extremely fine particles called *Molecules*. A *molecule* is the smallest portion of matter that can exist alone. Under ordinary conditions these molecules, or infinitesimal particles of matter do not touch each other, but are separated by relatively great spaces. This is due to the fact that molecules possess the inherent property of mutual repulsion, that is, each molecule tends to drive all other molecules as far away from itself as possible. The *mutual repulsion* of molecules is, however, more or less neutralized by the *attraction* which each molecule possesses for other molecules in its vicinity. These particles of matter are never at rest but are constantly swinging through definite orbits; it is this inherent tendency to orbital motion which causes the molecules to apparently push each other apart.

Energy may be divided into *Mechanical* or *Molar force* which produces changes in *masses* of matter; and *Molecular force*, which acts on the *molecules* of a mass. Heat is a form of molecular force which, when applied to a body, causes its molecules to swing through gradually increasing orbits, increasing the distance between each molecule and its immediate neighbors. This causes the *mass* of matter to *enlarge*, and consequently we say that a body "expands" when heated. When molecules are relatively close together, their mutual attraction is very strong, and the mass of matter would appear to us as being very hard and firm. Such a mass is called a *solid body*. Suppose a solid body were to be heated: the distance between the molecules would increase and their mutual attraction would gradually diminish; after a time a point is reached where this mutual attraction and repulsion just balance each other, and as a result, we have a form of matter in which the particles are so loosely held together that the slightest force is sufficient to break them apart. Matter in this condition is called a *liquid*. Application of heat to a liquid causes a still further increase in the distances between these molecules with a corresponding decrease in mutual attraction. At a certain point the mutual attraction is less than the repulsion and we have then a form of matter called a *gas*, in which the particles tend to diverge indefinitely; consequently the volume of a gas is limited only by the size of the vessel in which it is contained. The above-mentioned property of gases is of great importance, as it has made possible the discovery of the minute entities of which, not only *molecules*, but their component *atoms* are constructed. These particles may be regarded as units of force as well as units of matter. From the latter standpoint they are called *Corpuscles*; from the former, *Electrons*.

The *electron* is, therefore, the structural unit of all phenomena. It is a minute charge of *Negative Electricity*, self-centered and integral. There is no good reason for supposing that an absolute, solid, material body underlies and supports this negative charge. In a free state, electrons repel each other, yet they are capable of forming alliances, uniting into groups consisting of from 800 to 200,000, each electron of which swings or vibrates through a definite orbit so that a miniature solar system is

formed, the electrons representing the planets, and being held in equilibrium by the attraction of a hypothetical central sun. These wonderful minute systems constitute the *atoms* of the various chemical elements, the number of electrons in a given group determining its physical and chemical properties and its atomic weight. Thus the Hydrogen atom consists of about 800 electrons and has an atomic weight of 1. Uranium has over 200,000 and an atomic weight of 239. Between these extremes lie the seventy odd groups of electrons which constitute the chemical elements.

In each atom the mutually repellent electrons are held in a state of harmonious orbital motion by a centralizing atmosphere of *Positive Electricity* in which they are apparently suspended at equilibrium. In the solar system the planets are similarly held by the sphere of solar attraction. Imagine this sphere of attraction to still exist after the removal of the sun and we have a crude idea of the nature of the Positive Electricity which holds the Electrons together in the atom. A simple yet very instructive experiment will demonstrate the universal law of harmonious association, whereby the electrons are formed into atoms.

Several dozen fine steel needles are magnetized from a powerful electro-magnet, so that all the points have a like positive polarity. Each needle is thrust vertically through a small disk of cork and placed in a large, shallow basin of water. The needles are held in an upright position by their floats and the mutual repulsion between the magnetism of the points above the water and that of the "eyes" beneath the water causes the needles to form a circle around the inside rim of the dish. Now, slowly lower over the center of the dish the *negative* pole of a bar magnet and when the lines of force radiating from it strike the periphery of the dish, the needles will slowly move toward a common center, stopping when the attraction of the overshadowing magnet just balances the mutual repulsion of the polarized floats. In this way, by employing a greater or less number of needles, a variety of beautiful geometrical figures will be formed. The exact number of needles required to produce a certain figure can be determined only by experiment.

With some of these figures the *addition* of a needle will cause

a dissolution of the regular arrangement, while the *withdrawal* of one will *weaken* but not *destroy* the integrity. Other figures respond in an exactly opposite manner.

Now, these symmetrical groups are analogous to the atoms of the chemical elements, the experiment showing that stable arrangements of the floats recur at regular mathematical intervals, just as the atomic weights of the elements indicate the existence of a *Periodic Law* governing their formation. This Periodic Law was formulated by *Mendelejeff* some twenty years ago and laid the foundation of modern chemistry. Arranging the elements in an ascending scale, we have some seventy different forms of substance beginning with Hydrogen, with an atomic weight of 1, and ending with Uranium with an atomic weight of 239. The Uranium atom contains about 200,000 electrons and is the heaviest and most complex atom known to science. So ponderous is it, indeed, that sooner or later it breaks down spontaneously, forming an atom of Radium (which is less heavy and less stable than Uranium) and one or more simple atoms of the light gas *helium*. Uranium evidently marks the limit of electronic combination.

“Uranium, Thorium and Radium mark the end, not the beginning of a course of development. They signalize, we can dimly see, the point where the evolutionary design, so far pursued with success, ceases to be practicable. As the outcome of its execution we have the whole series of the chemical elements variously constructed of a primal stuff. And that primal stuff consisted, we are driven to believe, in a crowd of ‘electrons,’ almost infinite in number, incoherent in arrangement, boundlessly diffusive in space.” How were these “electrons” combined together to form an atom? It was not possible without the application of some force. It involved the *doing of work*. Electrons are, no doubt, adapted for agglomeration, yet they will not agglomerate unless under compulsion. Just so much energy as a substance gives out in going to pieces was assuredly expended in putting it together. “A gram of radium, according to *Professor Rutherford’s* indisputable statement, contains a store of power sufficient to raise 500 tons a mile high. An engine of 1,000 horse power would be kept working for three

hours to produce this small quantity of the heaviest of known metals. Whence did this power come? How and why was it directed in this particular channel?" Here we are met by the impenetrable secret of creative agency.

The sketch (Fig. 15) is intended to give a graphic representation of the break down of a Uranium atom. Some of the freed electrons have already re-formed into Helium atoms; the ma-

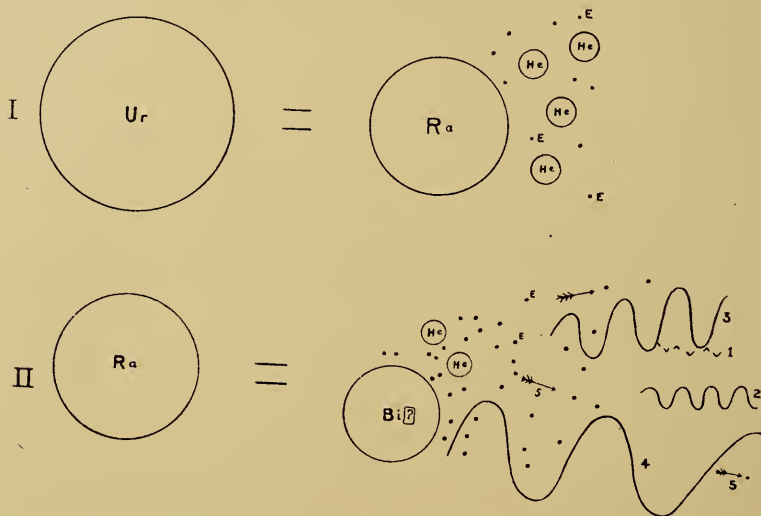

FIG. 15.—Schematic Diagram Showing Spontaneous Degeneration of Atoms.

I.—Uranium Atom (Ur), breaking down into the Radium Atom (Ra), and the Helium Atoms (He).

II.—Radium Atom (Ra), breaking down into a Simpler Atom (Bi), (which is probably Bismuth or Lead) and the Helium Atoms (He), giving out meanwhile free Electrons (E, E, 5), (Cathode Rays) and Ether Waves of various frequencies; 1, X-Rays; 2, Ultra-Violet Rays; 3, Light Rays; 4, Heat Rays.

(Redrawn and Revised from a Sketch by Doctor Batten, in the "Archives of the Roentgen Ray.")

majority of the remaining electrons ultimately unite to form a single atom which would appear much larger than the Helium atoms but slightly smaller than the original Uranium atom. Heat rays (4), Ultra violet-light rays (2), X-Rays (1), and streams of free electrons ("Cathode Rays," 5) are different varieties of radiant energy given off in the breaking-down process.

Almost all that we know concerning the electron has been learned through the study of the phenomena of Radium and of the electric discharge in Crookes' Vacuum tubes. ("X-Ray tubes.")

We have seen how electrons unite to form the different kinds of matter. Let us now consider them as sources of force. We shall find that the different manifestations of energy are the result of vibrations or perturbations of electrons acting individually or in collected units. The most subtle and most elusive type of force is that which we call *Radiant Energy*, and consists of transverse waves propagated in the *ether* by the orbital or axial rotation of individual electrons, either free or in the atom. Phenomena involving sudden or periodic interference in the motion of electrons through solids, liquids or gases, also give rise to waves of radiant energy. The crack of a whip causes a single pulse or radiating wave in the air which impinges on the ear drum as a sudden, sharp *noise*; the alternate to-and-fro vibration of a piano string, on the other hand, sends out a series of gradually diminishing waves which blend to form a *musical note*, of a pitch or frequency equal to that of the vibrating string. Single electrons moving at a high velocity, when suddenly stopped by some solid body, send out isolated "pulses" in the ether; when these pulses follow each other with great rapidity, X-Rays are generated. It is the extremely short wave length of these impulses which enables them to penetrate solids which are opaque to slower vibrations. X-Rays may be likened to a succession of "whip-cracks" in ether, while light waves are like musical sounds in that they result from the sustained vibration of electrons swinging in their definitely determined orbits. The bright lines of the spectrum are single pitches or "tones," their wave length and frequency being determined by the rate of rotation of the electrons in the different chemical atoms. The relation between the various forms of radiant energy is indicated in the following table, which was arranged by *Doctor Batten* of London.*

* "Archives," 1904, p. 173; Dr. Geo. B. Batten: "The Revelations of Radium."

TABLE OF WAVES OF RADIANT ENERGY

Rate of travel through the ether:

$$\left. \begin{array}{l} 300,000 \text{ kilometers} \\ 186,000 \text{ miles} \end{array} \right\} \text{ per second.}$$
 $\mu = \frac{1}{1000}$ millimeter.MM = millimeter = $\frac{1}{25}$ inch.

CM = centimeter.

M = meter = $39\frac{1}{2}$ inches.

KM = kilometer = 1,000 meters = 1,093 yards.

Complete Vibrations	Octaves	Wave-Lengths	Observations	
Per Second.	56			
	55	?	Approximate Probable position of X-Rays (Roentgen)	
	54	?		
	53			
4,503,599,627,370,496	52	0.1μ	Ultra - violet photographed in <i>vacuo</i>	
	51			
	50			
1,125,899,906,842,624	49	0.28μ	Photo limit of solar spectrum (Cornu)	
789,000,000,000,000		0.38μ		Visual limit at violet end of spec- trum
562,949,953,421,312		0.53μ		Green light
451,000,000,000,000		0.76μ		Visual limit at red end of spec- trum
281,474,976,710,656	48	1μ	Infra-red photographic limit (Ab- ney)	
	47			
70,368,744,177,664	46	4μ	Heat rays of solar spectrum, low- est, measured directly (Langley)	
	45			
	44	24μ	Heating rays observed by bolo- meter	
	43	}	Seven octaves unobserved, now partly occupied by probable position of N-Rays (Blondlot), 1903	
	42			
	41			
	40			
	39			
	38			
	37			
47,000,000,000	36	2 MM	Electric oscillations in small spheres (Bose)	
	35	6 MM		
	34	1.7 CM		
	33	2.6 CM	Electric oscillations in small spheres (Righi)	
	32	3.5 CM		
	31			
	30			
	29			
	28			

Complete Vibrations	Octaves	Wave-Lengths	Observations
	27		
	26	446 CM	Electric oscillations in Hertz resonator, 70 CM diameter
10,000,000	25		
	24	15 M	Electric oscillations from 1-pint Leyden jar.
8,388,608	23	30 M	Electric oscillations from flying-bullet photographs (Boys)
	22		
	21		
	20		
	19		
262,144	18	1.1 KM	Electric oscillations, Leyden battery circuit (Feddersen)
	17		
	16		
	15		
	14		
	13		
	12		
	11		
	10		
512	9	585 KM	Electric oscillations in very large battery circuit (Lodge)
	8		
157	7	1,910 KM	Electric oscillations from condenser I microfarad capacity
	6		
	5		
	4		
	3		
	2		
Once per second	1	{ 300,000 KM 186,000 miles	
Pendulum beating	-1		
Seconds	-2		
Once in 4.7 seconds	-3	865,000 miles	Electric oscillations from storm in sun
	-4		

In this connection, the following hypothetical experiment is extremely instructive, as illustrating the relationship of vibration to radiant phenomena. It is quoted from a most remarkable little book entitled "Dynamic Thought," by *William Walker Atkinson*.

"To give one an idea of the differences produced by different rates of vibration, let us imagine a mass of iron, shaped like a great 'top,' capable of being impelled to 'spin' at a constantly

increasing rate of speed, by some mighty will. At first it is seen as a slowly spinning top, manifesting nothing but slow motion, to our senses.

“Now, imagine our top spinning at a rate doubling each second. The first second the top spins at the rate of two revolutions per second. We notice no change, except that we can see the movement. The next second the revolutions are doubled to four per second. Then, doubling each second, we have, respectively, revolutions of eight per second, then sixteen, and then in the fifth second, thirty-two per second. Then we begin to notice a change.

“When the revolutions reach thirty-two per second the friction of the moving top on the air causes it to give forth a very low, deep bass note of *Sound*. This note is like a low, deep ‘hum,’ and is the lowest possible of perception by the human hearing, although it is possible that some of the lower forms of life may be conscious of *still lower* vibrations.

“The sixth second the revolutions reach sixty-four, and the low note has grown much higher in the scale. The seventh second records a rate of 128, and the note has correspondingly increased. Then, as the seconds pass, we have successively, 256, 512, 1,024, 2,048, 4,096, 8,192, 16,384, 32,768, the latter, in the fifteenth second representing the highest note recognizable by the human ear, although it is believed that some of the lower animals may recognize sounds *too acute* for our sense of hearing. During this increase in revolutions from the fifth second to the fifteenth, the sound-note has risen rapidly in the scale from the low sullen “hum,” on through the notes of the musical scale, and beyond the range of instruments, until the shrillness becomes so intense as to be almost unbearable, and finally terminating in a shrill, piercing shriek like the ‘squeak’ of the bat, only long drawn out.

“Then from the termination of the sound (by reason of the rate of vibration having become too high) silence reigns for thirty seconds—absolute silence, in spite of the rapidly increasing rate of vibrations; in fact, *because of it*.

“When the forty-fifth second is reached, and the revolutions have attained the rate of 35,184,372,088,832 per second, our

top begins to emit heat-rays, increasing each second. Then a little later a dull, dim glow may be noticed. Then, as the seconds fly, the dull glow manifests a deep dark-red color, such as one notices in the iron of the blacksmith's shop, soon after it begins to 'glow.' Then, on and on, as the seconds fly, the deep red grows lighter and brighter, gradually changing into orange, then into yellow, then into green, then into blue, then into indigo, then into violet, and then into the color of 'white heat.' Then this 'white heat' changes into a still more dazzling white, and then a white impossible to describe appears, so bright, clear and brilliant that the eye cannot bear the sight. Then suddenly, the intense brightness is succeeded by absolute darkness, and the moving top cannot be seen by the eye—and yet it moves on. The highest recorded chemical rays of light are estimated to equal a rate of vibration of 1,875,000,000,000,000 per second. The vibration of the lowest shade of red light is estimated at 450,000,000,000,000, and the highest of violet at 750,000,000,000,000 per second, so we may imagine what the highest line on the spectrum is like.

"Still vibrating, our top, which has become now a mass of vaporized iron, rapidly tends toward still more ethereal forms. It has passed out from the region of light-waves, into another 'Unknown Region' of vibrations, in which region, however, exist the vibrations known to us as the 'X-Rays,' etc. It is throwing off great quantities of *electrons*. If we were to use a fluorescent screen we would be able to observe the phenomena of the *Roentgen* Rays, and similar manifestations of radiant energy.

"On and on vibrates the top of what we once called Iron—cold iron, warm iron, hot iron, melted iron, gaseous iron, *etherealized* iron, if you like. What it is like now, the imagination of man cannot conceive. Still the revolutions continue, doubling each second. What is being produced? The imagination cannot conceive of what this state of Substance, now being reached, is like. By a scientific form of poetry we might think of it as melting into Energy—pure Energy, if there were such a thing. Long since it has been resolved into its original particles—its electrons, and perhaps into the 'stuff' from which these

particles are made. But we must let the curtain drop—the wildest fancy cannot follow the dance of substance any further!”

Many of the most advanced thinkers agree that the electron hypothesis confirms the assertion that LIFE and INTELLIGENCE not only manifest through, but actually constitute all phenomena of the universe. They believe that not only in conscious man do we find the Intelligent Life Principle, not merely in the lower plants, but in the wondrous snow crystals, the particles of the oldest rocks, the molecules and atoms of the so-called “elements” and even in the primitive world-forming unit—the ELECTRON—we discover the fundamental qualities of *Living Mind*. This principle is exemplified in the electron by its Self-centered Unity, its “likes” and “dislikes,” its inherent power of vibratory motion and electrical reaction, and in its ability to ally itself for offense or defense with other similar units, and in their company to evolve to more complex and higher types—to the crystal, to the plant, to the animal, to the man—and beyond! The hard and fast line of demarcation between “Living” and “Dead” matter no longer exists. Up to 1820, chemists divided compounds into inorganic and organic, holding that the latter were obtainable only from vegetable or animal material and were formed solely through the mysterious agency of “*life*,” They supposed it impossible to create in the laboratory from inorganic elements an *organic compound*, such as rose-oil or albumen; just as some present day scientists believe that an impassable barrier exists between the highest chemical crystal and the lowest form of cell life.

Wöhler, in 1820, performed the synthesis of urea from ammonium cyanate, and proved that it was possible to reproduce in the laboratory all the chemical combinations existing in living structures. Almost any day another “*Wöhler*” may startle the world by apparently “creating” from chemical substances a low form of so-called cell life. Already *Professor Loeb* and *Professor Mathews* have come dangerously near this achievement, and they have shown that when this gap is bridged, it will be through the agency of the more subtle forms of electricity.

Similarly, it will be but a question of time and experiment ere the exact electrical nature of normal vital activity will be ascer-

tained. Refinement of apparatus will enable the physician to generate and apply to the diseased organism electrical forces of the exact voltage, wave form and frequency required to restore to the normal the organs and functions deranged by the disease in question.

Electro-therapeutics, which has not even been considered worthy of a place in the curricula of a number of prominent medical colleges, will then become the most important subject in a medical education.

CHAPTER III

ELECTRO-PHYSICS, FROM THE STANDPOINT OF THE ELECTRON THEORY

FROM a consideration of the previous chapter it will be readily understood that the advent of the "Electron Theory," while greatly broadening and amplifying our knowledge of the nature and causes of natural phenomena, nevertheless makes it necessary for a thorough revision of the laws and definitions which have been generally taught and accepted up to the present time. For example, we have been taught that electricity flows from the positive to the negative pole of a circuit, and that the electricity in a Positively charged body exists in a condition of increased pressure or concentration, the reverse being true in the case of a Negatively charged body. Physics has taught us that Electricity is an indefinable, elastic "something," equally diffused throughout all matter; and that by removing a portion of the Electricity contained in a given body, and adding it to another body, a Positive charge would be communicated to the latter; while the first mass would be left in a Negative condition. A Positively charged body was analogous to a chamber filled with *compressed* air; a Negatively charged body, to one filled with *rarefied* air. These statements have been generally regarded as correct, and have been of no little assistance to the student of electro-physics, but our recently acquired knowledge of the *real nature* of electricity has demonstrated the incorrectness of the above statements, as well as of many other explanations and theories promulgated in the various books on physics and electricity, which have been published within recent years. The profound, epoch-making character of the discovery and elaboration of the "Electron Theory," is not generally realized at the present time, except by investigators and students of pure science. It has been the writer's experience that the members

of the medical profession, including even a majority of the electro-therapeutic specialists, are almost entirely ignorant of the great practical significance, and the wide vista of possibilities which have been opened to us by the discovery of the "Electron Theory." In writing this book, the author has had occasion to consult a vast amount of literature relative to *Electro-Therapeutics*; and has been impressed with the confusion and ambiguity resulting from the attempt to employ the terms and definitions of "Nineteenth Century Electro-physics," in conjunction with the revised statements of facts deduced from the "Electron Hypothesis." Within the ensuing year many standard works on physics and chemistry will doubtless be revised and rewritten in the light of our recently acquired knowledge, but as no such textbooks are available at the present time, the writer has deemed it advisable to incorporate in the present volume the main facts of the electron hypothesis; and the elementary principles of electro-physics, as viewed from this modern standpoint.

The first part of this task has been completed in the preceding chapter. The general nature of physical phenomena has been considered and the evolutionary process whereby electrons are united into groups of different sizes and arrangements—forming the atoms of the chemical elements—has been explained in detail. In order to understand the abstruse laws and principles exemplified in the production and application of High-frequency Currents, it is absolutely essential that the student obtain a clear comprehension of the fundamental processes which form the basis of all electrical phenomena, and to this end a brief summary of the simpler facts of electro-physics in the light of recent discovery, will now be given.

Electrical phenomena result, primarily, from the Motion of Electrons, either in a free state, or united into groups, called Atoms. Every atom of every molecule is so constituted that it may be made to give up, or take in one or more Electrons. Atoms of Monad Elements, if basic, or metallic, readily *give up a Single Electron*, the remainder constituting a *Positive Ion*. Dyad or Triad atoms give out—respectively, two, and three electrons, when they become Ions. Acid-forming Elements do

not really give up electrons, but each atom *attaches to itself* an electron and in this manner becomes a *Negative Ion*. Chemical action results from—or consists in—the union between negative and positive Ions to form *Neutral Molecules*, called *Salts*.

An *Electron* is a *Unit charge of Negative Electricity*. *Neutral atoms* consist of one or more thousands of electrons, held in equilibrium in a sphere of positive electricity. There is no such thing as a “positive electron”; that is, an isolated unit of positive electricity, capable of existing in a free condition, as in the case of the negative electron. *Positive charges*, therefore, are found only in association with atoms, and the *Unit of Positive Electricity* is an Atom which has temporarily parted with one of its component electrons; it is, in other words, a *Positive Ion*.

The various forms of electrical phenomena may be classed under the following heads:

(1) **MAGNETISM.**—Which results from the unequal distribution of electrons in a mass of iron or steel.

(2) **“STATIC” EFFECTS.**—Or conditions of *electrical “charge,”* which result from the addition, or withdrawal of electrons from a neutral mass of matter. The temporary addition of electrons to such a mass renders it “*negatively charged*”; the withdrawal of electrons results in a “*positive charge*.” (The attention of the student is called to the fact that these definitions are the *exact reverse* of those taught before the advent of the “*Electron Theory*.”)

(3) **“DYNAMIC,” OR “KINETIC” EFFECTS.**—Including the various phenomena of “*Electrical Currents*.” These may be divided into: (a) Currents flowing through *solid conductors* (such as copper wires), in which the electrons are *passed along* from atom to atom. (b) “*Electrolytic*” Currents which accompany chemical action in solutions, in which the charges move as “*Ions*”—the electrons being *attached*, rather than *free* as in (a). (c) Electrical discharges in air at ordinary pressures, “*Electric Sparks*,” in other words, which consist of sudden, or momentary *surges* or *discharges*, in which both Ions and Electrons are projected across an air space separating two conductors. (d) *Electrical currents in gases at extremely low pressures*; these consist almost wholly of Streams of Free Electrons, moving with

great speed from the "Cathode" (or negative electrode) to the "Anode" (or positive electrode) of a highly exhausted glass bulb, which is called a "Crookes Tube." The "Streams of Electrons" just mentioned are called "Cathode Rays."

Magnetism*

Magnetism, while usually treated as an electrical phenomenon, has remained a puzzle to physicists up to the present time. The electron theory, which has done so much to dispel the confusion in the minds of students regarding the fundamental nature of electricity, has been of great assistance in explaining the phenomena of magnetism, and electro-magnetic induction. In a bar of pure iron, or soft steel, magnetism may be temporarily

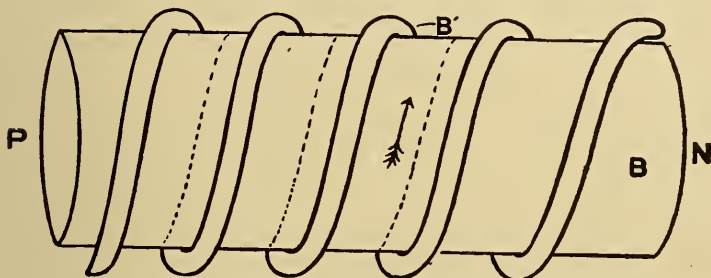

FIG. 16.—Magnetism Induced in Iron Bar by Current in Coil of Wire.

induced by the passage of a current of electricity through a spiral coil of wire surrounding it. As has been stated, an electric current involves the passage of electrons through the circuit from the *Negative* to the *Positive* pole. In the wire (*B'*, Fig. 16) streams of electrons are flowing around and around the soft iron bar (*B*), in a gradually ascending spiral path (as indicated by the arrow). Each electron may be regarded as a *Moving Magnet* attracting electrons in the bar (*B*), which consequently move through a spiral path, in the superficial layers of the iron, corresponding to the number of turns in the coil (*B'*). The streams of electrons rushing around this path, being unable to escape

* Since this chapter was written discoveries have been made which show that the above theory of magnetism is not entirely correct: it should be accepted, therefore, merely as an analogy or aid to the comprehension of the processes of induction.—AUTHOR.

from the bar, concentrate in the upper end (*N*), which in this way becomes the *negative pole* of a *temporary* or *electro-magnet*. The lower end (*P*), from which a large number of electrons have been withdrawn, would form the corresponding *Positive Pole*. Now, supposing the current, which is causing the concentration of Electrons in the upper end of the Bar, be suddenly interrupted, the particles in the Iron Bar will endeavor to restore equilibrium and will therefore return to their original positions by the same spiral path which they followed in the course of their upward movement. As every moving electron is a minute magnet these particles in the iron will attract the *electrons* in the *coil of wire*, causing them to move around the spiral in a direction opposite to that which they traveled in the form of an electric current, in the first stage of the experiment. In this way a second current would be set up, or "Induced," provided the electrons were free to move in the wire coil; for example, if the two ends of the coil were joined, forming a closed circuit, a temporary current of electricity would flow through this circuit simultaneously with the return of the electrons in the bar to their original position. If a bar of hard steel be substituted for the soft iron in the above experiment, the electrons will not return after the interruption of the electric current, but will remain *fixed*; concentrated along spiral lines at the negative pole of the magnet; in other words, the bar will become *Permanently Magnetized*.

The "*Ether*" is in some way, intimately associated with the magnetic properties of electrons. When a moving electron is suddenly stopped it acts on the ether as a stone acts upon the surface of a pool of water in which it is dropped, causing "*Waves*," which radiate in all directions. These waves, when produced by the sudden stoppage of a succession of electrons rapidly moving in a highly exhausted bulb, are of *exceedingly short duration* and of *very "High-frequency"*; they are, in fact, what we know as the "*X-Rays*," of *Roentgen*.

Electrons, moving or swinging in regularly defined orbits, produce waves in the ether whose frequency corresponds to the number of electronic rotations in a unit of time. Thus the electrons in the sodium atom, which move around their orbits

500,000,000,000,000 times per second, give off (when in an incandescent state, as in the flame of a *Bunsen Burner*) "*Electro-Magnetic Radiations*" or *Waves* in the *Ether* of exactly the same frequency, and a wave length of .65 micron.* Such rays would appear to us as orange-yellow Light, and would, in reality correspond to the "Delta" ("D") or "Sodium Line" of the *Solar Spectrum*.

Other varieties of electronic vibration or rotation give rise to other forms of *Ether Waves*; these vary in length and frequency,

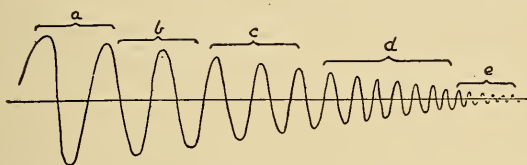

FIG. 17.—Diagram Indicating Wave Length and Frequency of Known Forms of Radiant Energy.

a, Mertz Waves. b, Heat Waves. c, Light Waves. d, Ultra Violet Rays.
e, Roentgen (X-) Rays.

from the short, rapid "X-Rays" (before mentioned), to the ponderous waves produced by *storms in the sun* (see Table in Chapter II).

The above, briefly stated, constitutes the "Electro-magnetic Theory of Light," first formulated and mathematically verified by *Clerk Maxwell*, in 1865—years before the "Electron Theory" was dreamed of! In the light of our present knowledge, we may classify practically all natural phenomena as, *either* the movements of electrons themselves, or, as the *results* of their motion in the form of *waves in the ether*; that is, as "*Radiant Energy*."

*The above figures are only roughly approximate.

CHAPTER IV

ELECTRO-PHYSICS (*continued*)

The Nature and Generation of Alternating Currents

IMAGINE a circular tube of metal filled with air or some elastic fluid, and provided at one point of its circuit with a rotary pump, whereby a circulatory motion can be conveyed or imparted to the fluid in the pipe. (See Fig. 18.) If this pump be set in motion, fluid will be drawn from point (*A*) and forced toward point (*B*), the result being a diminished pressure or partial vacuum at (*A*), and increased pressure at (*B*), which being transmitted causes a flow of the fluid in the direction of

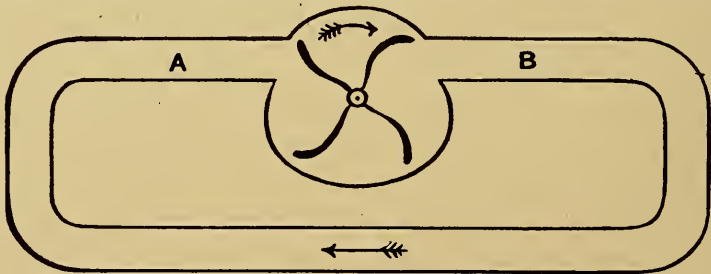

FIG. 18.—Hydraulic Analogue of “Continuous Current” Circuit.

the arrow, in an attempt to restore the disturbed equilibrium. This results in a continuous current circulating in the tube. Now, supposing, instead of the pump, we imagine the circular pipe to be joined to the extremities of an ordinary engine cylinder with a piston (*C*) sliding back and forth by the action of the rod (*D*) (Fig. 19). If the piston be pushed to the position (*B'*), a temporary flow will be established which will cease when the end of the cylinder has been reached by the piston. Withdrawing the piston to (*A'*) causes a temporary current through the tube in the opposite direction. Now, if the piston be

mechanically operated back and forth at regular intervals, a reciprocal or alternating motion is communicated to the fluid in the tube, the motion being graphically represented by the diagram (Fig. 20). Starting with the piston at (A'), as it is

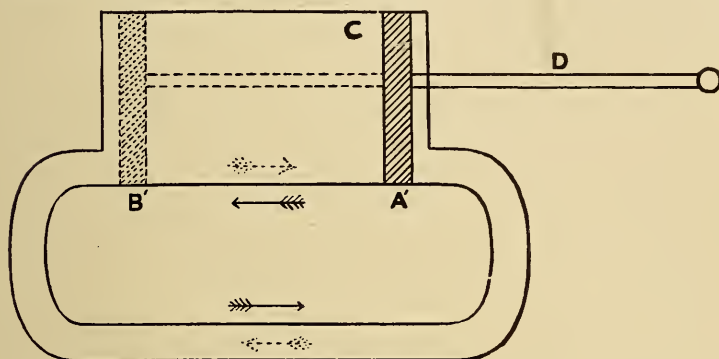

FIG. 19.—Hydraulic Analogue of “Alternating Current” Circuit.

forced in, the fluid moves faster and faster, the most rapid motion being at the middle of the stroke, the speed or flow gradually subsiding as the piston comes to rest at (B'). Withdrawal of the piston causes a similar flow in the opposite direction, which is represented in the figure by the curve below the horizontal line (the latter, called the “*Abscissa*,” is mathematically divided to indicate *time units*, such as *seconds* or *minutes*; the vertical line, called the “*Ordinate*,” marks the rate of speed

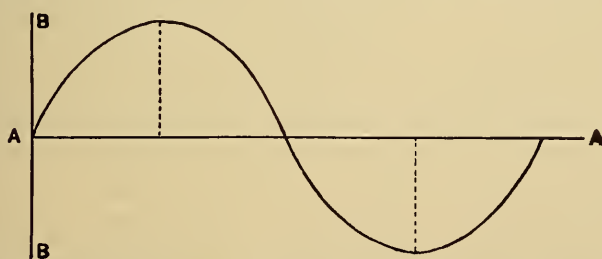

FIG. 20.—“Graphic tracing” of Alternating (Sinusoidal) Current.

of the moving column of fluid). In electricity this method is commonly used to indicate graphically the nature of currents, the divisions of the ordinate being usually made in terms of “Volts” (*i.e.*, in units of electrical pressure, potential, or Electro-

motive force). It is the "voltage" that forces the electricity through the wire or other material which forms its circuit and creates an *electrical current*. The *electricity* or moving stream of electrical particles, which is forced through the circuit by the *voltage*, is measured in terms of the electrical unit of intensity, called the "Ampere."

When water is forced through the pipe (See Fig. 19), it meets with *resistance* due to the friction of the walls through which it flows. This resistance depends mainly upon the size and nature of the pipe; similarly, a wire through which a stream of electricity flows offers *resistance* to its path, and the resistance is proportional to the size and length of the wire, provided the latter is composed of the same material throughout.

Different substances offer different degrees of resistance to the passage of electricity per unit of length and thickness. The conductivity of bodies is therefore learned by comparing their respective resistances. The unit of resistance is called the "*Ohm*" and is represented by a column of mercury one millimeter in diameter and one meter long. A pressure of one *Volt* maintained between the extremities of a wire of one *Ohm* resistance will cause a continuous flow of a current of one *Ampere* through the wire. Difference of potential ("Voltage") is maintained between the two ends of an electric circuit by (1) *Batteries*, which transform the energy stored up in the chemicals of the cell into *active* or *Kinetic Electrical Energy*; (2) by *Generators*, which transform the *Mechanical force* into an equivalent amount of electrical energy. Under the head of "Generators" may be included (a) dynamos and magneto machines, which operate through *Electro-magnetic induction* and (b), Static Machines in which the electricity is generated either by friction or by *Electro-static Induction*.

When the poles of a battery are connected by a conducting wire, a *continuous, unidirectional* current of electricity will flow as long as the chemical action goes on inside the cell. Such a current would be similar to the continuous flow of fluid around the pipe in Fig. 18. The size or quantity of the stream of energy flowing through the wire (expressed in "Amperes"), depends upon the difference in electrical pressure or potential between

the positive and negative terminals of the battery and upon the resistance of the circuit. This is an example of "Ohm's Law," which states that the *quantity* or *amperage* (C), of a current, is equal to the voltage (E), divided by the resistance (R), expressed in *Ohms*. Thus when two of the three properties of an electrical circuit are known, we can readily find the third, the formula in each case being as follows:

$$C = \frac{E}{R} \quad R = \frac{E}{C} \quad E = R \times C$$

The simplest *Generator* consists of a coil of insulated wire wound upon a soft iron core and revolving between the poles of a U-shaped or horseshoe magnet. (See Fig. 22.) The temporary magnetism induced in the iron core produces radiating *lines of force* corresponding to a *stress* or *strain* in the surrounding ether, which, when suddenly released, produces, or *induces*, a momentary current in the coil of wire. In the course of its revolutions between the poles of the magnet, the transient electrical impulses flow through the coil alternately in opposite directions, forming an *Alternating Current* as represented by the curve (Fig. 20).

The alternating current thus formed is conducted to any desired external circuit by means of two insulated rings, revolving in contact with stationary metallic brushes. All dynamos or magnetos depend upon the above principle but in the Direct-Current Dynamos, a device called a *Commutator* is employed, which sends all the electrical impulses out in the same direction. In order to obtain a clearer idea of the phenomena of electromagnetic induction, it may be well to briefly review the theory of the ordinary *Ruhmkorff* Induction Coil. By introducing a permanent magnet into a coil, the ends of which are connected to a delicate galvanometer, a momentary impulse of electricity is induced, which is indicated by the fluctuation of the needle of the meter, and, when the magnet is withdrawn, a second impulse is indicated, opposite in direction to the first. (See Fig. 21.) The magnet may be allowed to remain in the coil indefinitely without any evidence of current. It is evidently the introduction and withdrawal of the magnet which induces the current in

the coil. In other words, it is not merely the presence of lines of magnetic force, but the *act of their formation or destruction* which produces the inductive effect in the coil of wire. By successively introducing and withdrawing the magnet from the coil, an alternating current would be generated, the counter-

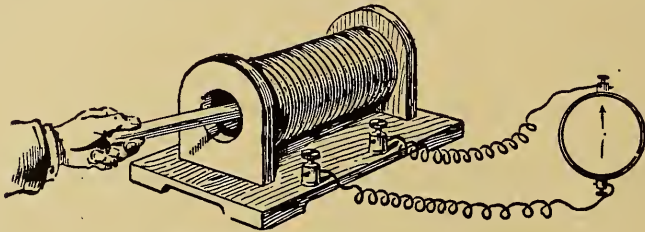

FIG. 21.—Magnetic-electric Induction. (Williams.)

part of the movement of the water in the tube (Fig. 19) when the piston is in operation. A more efficient manner of producing an alternating current is to rotate the coil of wire so as to present the extremities alternately to the poles of a horseshoe magnet, as described above (Fig. 21). The number of *impulses* or *alternations* in a unit of time is called the *frequency* of an alternating current and depends, in the above generator, on the rapidity with which the coil revolves. An impulse in each direction is called a *cycle* and is represented thus (\sim).



FIG. 22.—Diagram of Simple "Magneto," Generating an Alternating Current.

In technical parlance we indicate the frequency of a current in terms of *Cycles per second* or *Alternations per minute*. This is an accepted custom, *alternations* being always associated with *minutes* and *cycles* with *seconds* (thus a "60-cycle current" is understood to mean a current of sixty cycles per second; we could allude to the same current as one of "7,200 alternations" meaning 7,200 *alternations per minute*). Currents are said to be of high or low frequency according to the great or small number of cycles or alternations in a unit of time. When a certain frequency is reached the currents manifest new and unique properties which differentiate them markedly from low-frequency currents. These peculiar properties are manifested both physically

and physiologically, the latter being the basis of their therapeutic use. High-frequency Currents were first studied from a physical standpoint by *Nicola Tesla* and *Professor Elihu Thomson* (see Chapter I). Both *Tesla* and *d'Arsonval* first produced these currents by employing alternating generators operated at a high rate of speed and provided with a large number of revolving coils and an equally large number of field magnets. Electromagnets were employed instead of permanent ones on account of their very much greater power and convenience. *Tesla*, in this manner, with an alternator having 300 pole pieces, revolving 5,000 times per minute, obtained currents of 10,000 alternations per second (technically a current of "5,000 cycles"). He found that the peculiar properties which become manifest at this frequency, were strikingly emphasized and augmented by raising the current to a very high potential or voltage by means of a "step-up" transformer. In speaking of a High-frequency Current in the ensuing pages it will be therefore understood that we refer to an *Alternating Current of Very High-potential and Very High-frequency* (generated usually by the methods of *Tesla* and *Thomson*). High-frequency Currents of *low potential* will be referred to as "*d'Arsonval Currents*" while the *unipolar high-frequency high-potential flux*, obtained from an "*Oudin apparatus*" connected to a "*d'Arsonval Solenoid*," will be denominated as a "*Resonator Discharge*." The currents employed to-day in High-frequency Therapeutics are of much greater frequencies than those obtained from alternating generators and are produced in quite a different manner. The great number of alternations is obtained by the *disruptive discharge* of a *condenser*. A "condenser" (*Leyden Jar*) is a device which has the property of absorbing or storing up electricity and giving it out suddenly in the form of an electric discharge, when the difference in potential between the positive and negative plates is sufficient to overcome the resistance of the external circuit. *Professor Rowland* of Johns Hopkins University first employed the condenser discharge for the production of High-frequency Currents in 1889. Two years later *Tesla* described his apparatus in which condenser currents were employed to obtain very high-frequency effects. The practical and economic generation of true High-frequency,

High-potential Currents was made possible a few months later by the invention of *Professor Elihu Thomson*. In *Tesla's* original coil the step-up transformer, from which the final High-potential Currents were obtained, was very complicated, and consisted of two concentric coils formed of many layers of gutta percha insulated wire wound over a central soft iron core, the whole being insulated with the greatest care, and hermetically sealed in a vessel of boiled-out oil, all air having been exhausted by an air pump. *Professor Thomson* substituted for this cumbrous device, a transformer without iron core, the ether stresses or lines of force being formed directly by the inductive action of the low-potential High-frequency Currents passing through the primary coil. The latter consisted of a single layer of coarse cotton-covered wire wound on a fiber tube slipped inside of a larger tube upon which was wound a layer of much finer wire, in which the High-potential, High-frequency Current was induced. A simple bath of kerosene oil was found by *Professor Thomson* to be fully as satisfactory as the exhausted boiled-out oil of *Tesla*. The final step in the simplification of High-frequency Apparatus was made by the present writer in 1897, who so modified the size and position of the two coils as to allow of their being imbedded in a solid insulating medium of paraffin and rosin. Hundreds of coils made from the writer's formulæ are in use throughout the world, and it is almost as rare to hear of such a coil breaking down as in the case of those immersed in a bath of oil.

In order to clearly understand the action of condensers in the production of High-frequency Currents, it will be necessary to study in detail the construction of the *Leyden Jar*, the nature of its discharge and the conditions which modify this discharge. Whether the latter is a series of electrical oscillations of high frequency or a simple unidirectional impulse, depends upon the resistance of the external circuit formed between the plates of the condenser or *Leyden Jar* (Fig. 23). If this resistance be considerable, the electricity will cease to flow when equilibrium is established. On the other hand, if the resistance be small, the flow of electricity will not stop at the neutral point, but will act as if the stream of electrons possessed

material properties and acquired *momentum*, thereby charging the condenser again in the opposite direction, *again* discharging

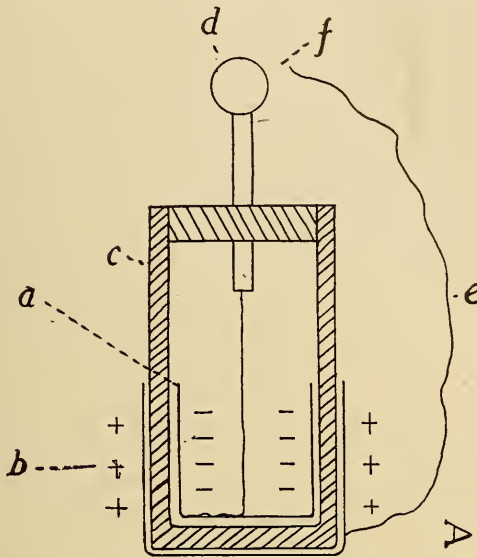

FIG. 23.—Leyden Jar, or Condenser.

a, Inner Coating. *b*, Outer Coating. *c*, Glass Jar. *d*, Brass Ball Terminal
e, Discharging Wire. *f*, "Spark-gap."

past the neutral point, and repeating the operation until the electrons gradually come to rest. This operation is analogous to the movement of water in a U tube (See Fig. 24). Imagine the right hand column depressed, thereby raising the opposite

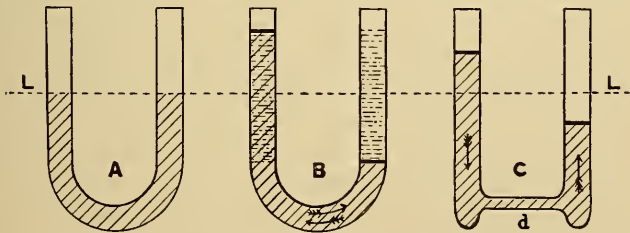

FIG. 24.—A, Water at Rest in "U" Tube. L, Normal Level. B, Displaced Water Oscillating Before Coming to Rest. C, "U" Tube with Arms Joined by Capillary Tube (*d*) which Prevents Oscillations in Water.

column; when released the water flows back by gravity, but its momentum carries it past its original position, and it oscillates

back and forth, the height reached by each movement being less than the preceding one, until the water gradually comes to rest. Imagine now that the two arms of the U tube be connected by a fine capillary tube, opposing great resistance to the flow of water; in the latter case when the water is depressed and suddenly released, the resistance of the capillary tube opposes the sudden flow of water and prevents its acquiring momentum, and it consequently slowly returns to the neutral level without any oscillatory movement. In an analogous manner the discharge of a condenser is *oscillatory* so long as the *resistance* of the external circuit is *low*, while with *high resistance*

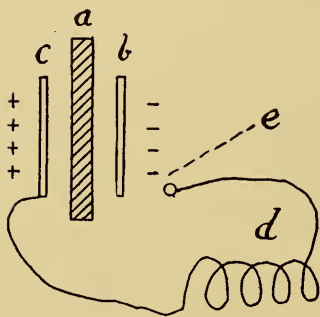

FIG. 25.—Plate Condenser with Inductance Coil and Discharging Circuit.

it becomes a single *unidirectional* flow, as above stated. Analogy is at fault, however, in one respect; according to the example of the water in the tube, the oscillations will be prolonged to the greatest extent when the walls of the tube possess the least possible resistance, that is, when the tube has the greatest size. In studying a condenser circuit, however, we have to deal with a *new form of resistance* called *Inductance*. Inductance acts only

upon alternating currents. This inductance results from the flow of the alternating current through a *coil*; the current reacts upon itself in the convolutions of the coil, and this reaction is called Inductance. With a given coil having a certain number of convolutions wound upon a tube of certain diameter and of given size of wire, there is a certain frequency of alternations to which, instead of opposing resistance, the coil will actually increase the duration of the oscillations for each discharge. The frequency of the oscillations of a condenser discharge depends upon its size, technically spoken of as its "capacity"; that is, the amount of electricity which the condenser is capable of storing up at a given voltage or pressure. A definite mathematical relationship exists between the capacity of a condenser and the inductance of the circuit through which it discharges, and

in order to obtain High-frequency Currents under the most favorable circumstances, there must be experimentally determined an attunement giving this particular relationship.

To understand this action let us consider the well-known phenomenon of acoustics. A tuning fork when struck emits *sound waves* of a certain *pitch* or *frequency*, which rapidly diminish in amplitude and soon cease entirely. An organ pipe of a different pitch held to the vibrating fork, has little or no effect upon the sound. If, however, the pipe be attuned to the exact pitch or frequency of the fork, the sound waves are greatly increased in volume and duration. This is called the phenomenon of resonance, and the action of the organ pipe on the vibrations of the tuning fork is exactly analogous to that of the inductance coil on the discharge of a condenser. When the inductance and capacity of a circuit are exactly balanced or attuned one to the other we have a condition of "*electrical resonance*," and the coil which re-enforces the oscillations is called the Solenoid of *d'Arsonval*. (See Chapter I.)

CHAPTER V

PHYSICAL FACTORS INVOLVED IN THE GENERATION OF HIGH-FREQUENCY CURRENTS

DESPITE the complex and diversified character of the external world, and the countless number of totally different things of which it is composed, we find by analysis and comparison that, fundamentally, Nature's processes are definite, simple and along parallel lines. The apparently abstruse principles underlying the most complex phenomena are often exemplified in the simple occurrences of everyday life. Newton pondered for years on the mystery of Gravitation, but it was the simple fall of an apple that finally led him to formulate its laws. This is an illustration of the "*comparative method of study,*" or "*study by analogy,*" which has been the main factor in the scientific progress of the past century. Until this method was applied to the study of electricity, it was extremely difficult for the student to comprehend the relation and true meaning of the terms "potential," "intensity" and "resistance," and their corresponding units—the Volt, Ampere and Ohm. At the present time we explain these terms by the study of a stream of water flowing from an elevated reservoir through a pipe connected to a small water-motor. The speed of this motor is proportional to that of the water which flows through it, and depends on the degree of elevation of the reservoir. The higher the reservoir the greater the pressure of the water in the pipe and consequently the greater the speed at which the stream moves. Water flowing from a height of a hundred feet has a "*pressure,*" or "*head,*" of one hundred feet which would determine the velocity or force of the stream. The water encounters "*resistance*" due to the friction of the walls of the pipe and the inertia of the revolving wheel in the motor. A certain force or head of water flowing through a pipe having a given friction or resistance, would

enable the motor to perform a definite amount of mechanical work; if the resistance of the pipe be doubled by making it either twice as long, or of half its original diameter, the amount of work done by the motor would be just one-half of its previous performance, inasmuch as the amount of water flowing through it in a given time is just one-half of the original amount. Now the laws exemplified in the stream of water are practically the same as those which govern the flow of a continuous current of electricity from a source of supply—such as a dynamo—through

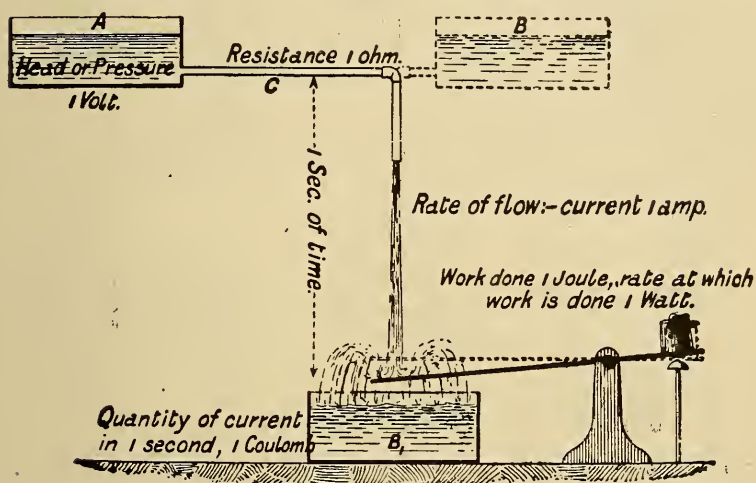

FIG. 26.—Diagram Showing Analogy Between Falling Water and a Current of Electricity. (Williams.)

a length of wire to an electric motor. The amount of electricity, that is, the number of "Amperes," which flow through the motor in a given time are determined by the *pressure* or *voltage* of the current, and the *Resistance*, or "Ohms" of the wire and motor. A similar comparison has been given in a preceding chapter, but is reviewed here, for the purposes of impressing the student with the value of the method of teaching by "*Analogy*" or *Comparison*. (Fig. 26.) The water motor, pipe and reservoir, in the above example, constitute a "*Hydraulic Analogue*," in which the water represents the electricity. The work done by the electric motor varies with the pressure and resistance of the circuit just as is the case with the water wheel. The

obvious advantage of this method of study lies in the familiar commonplace character of the *Analogue*.

The various phenomena which take place in an apparatus generating High-frequency Currents are well exemplified in a

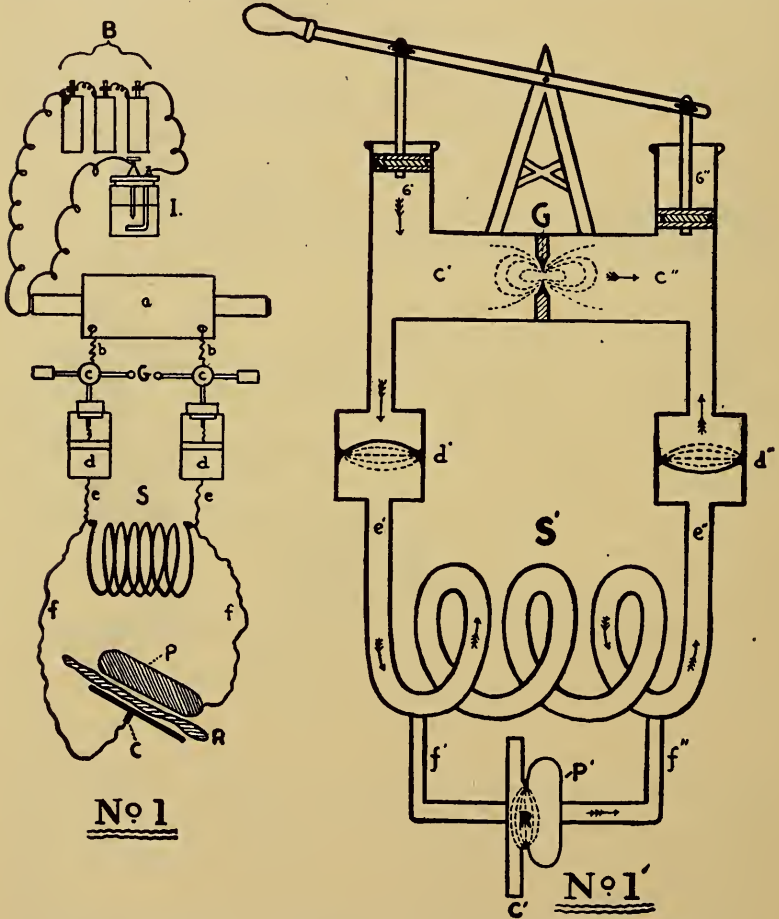

FIG. 27.—Plate I. D'Arsonval Circuit and Hydraulic Analogue.

Hydraulic Analogue, which has been used by *Professor Fleming*, *Dr. Elihu Thomson*, and other prominent lecturers. It has been used to explain the action of *Therapeutic High-frequency Apparatus* by *Mr. E. L. Ovington* in a chapter on "High-frequency Currents" in *Neiswanger's "Manual of Electro-Therapeu-*

tics." In the diagram (Fig. 27) Plate I represents a *d'Arsonval* circuit side by side with its hydraulic counterpart, while Plate II shows a *Tesla* circuit with its analogue. Similar letters are used to represent corresponding parts in the circuits and their

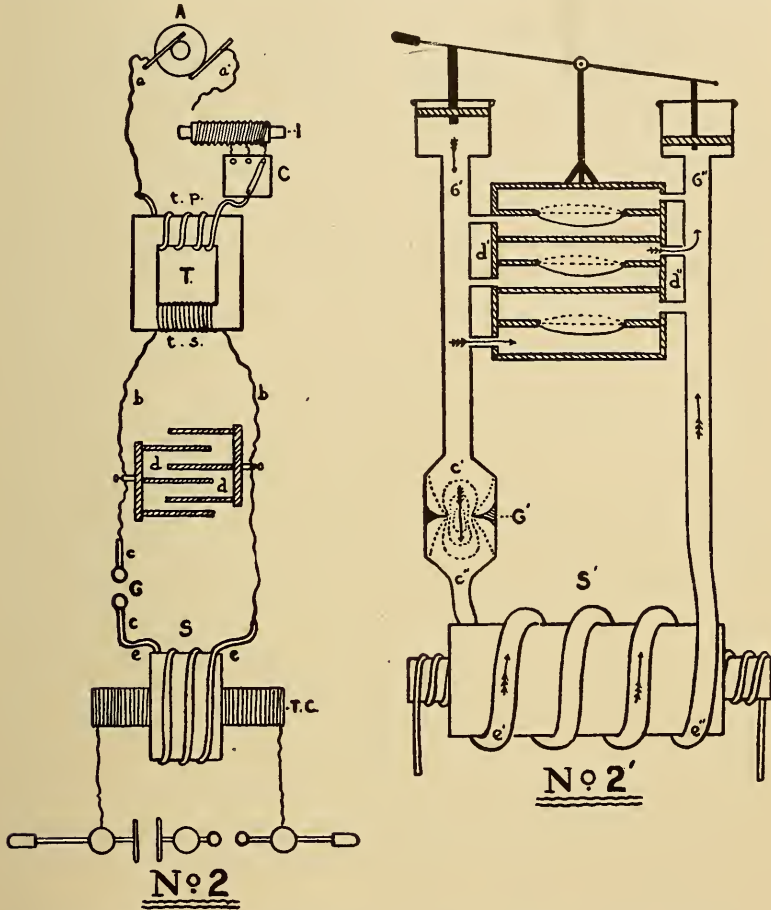

FIG. 27.—Plate II. Tesla-Thomson Circuit and Hydraulic Analogue.

analogues. Let us first consider the *d'Arsonval* method: (a) is a *Ruhmkorff* Induction Coil, excited by a current from the battery (B) interrupted by the "Break" (I) which induces in the Secondary coil an alternating current of high potential, which charges the *Leyden Jars* (d-d), through the wires (b-b), which are bridged

by the sliding rods ($c-c$), which form the terminals of the spark-gap (G). The outer coatings of the *Leyden Jars* are connected by the wires ($e-e$) to the Solenoid (S); two wires ($f-f$), connect the extremities of the Solenoid respectively to the patient (P), and the metal plate of the "Condenser Couch" (C). A current flows from the *Ruhmkorff* Coil into the jars ($d-d$), which are thereby charged equally but with opposite polarity; when the pressure in the jars, or rather, when the *difference in potential between the jars*, reaches a certain point, the resistance of the air-gap (G) is broken down, and the condensers discharge in the form of a Spark. As we know, this spark does not represent a *single impulse*, but a *series of impulses*, or oscillations, which diminish successively until the original resistance of the air-gap is established, and the sparks cease to pass. We may assume that by this time a second induced impulse will flow from coil (a) into the jars, and inasmuch as the *Ruhmkorff* current is of an alternating type, the jars will be charged in a direction opposite to that which gave rise to the preceding set of oscillations; the spark-gap will then be broken down, and a second set of oscillations will occur. These oscillations necessarily traverse the solenoid (S), and are transmitted or communicated to the external circuit represented by the patient and the plate of the Condenser Couch. To understand exactly how these effects are produced, let us consider their counterparts in the hydraulic analogue. The alternating impulses corresponding to those induced in the *Ruhmkorff* Coil (a) are represented by the alternate reciprocal motions of the piston rods which move up and down in the cylinders ($b'-b''$) causing motion or currents of the fluid in the two chambers ($c'-c''$), which are separated by the elastic diaphragm (G'). This diaphragm has the peculiar characteristic of "*self-repair*," or of *re-forming after bursting*, and may be conceived of as being composed of a thick sticky substance such as the viscid composition, or solution of rubber which is used in filling the so-called "Puncture proof" pneumatic tires. In the "candy pulls" of our childhood days, we may recall the breathless interest with which we watched the progress of the boiling molasses in the exciting moments preceding its removal from the fire; the viscid surface of the hot mixture was

convulsed by frequent volcanic eruptions in miniature; bulging dome-shaped protuberances would form, gradually increasing in size until they became almost hemispherical, finally bursting at the top, discharging a puff of delicious steam, and collapsing,

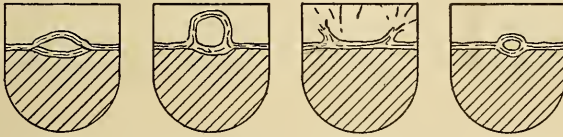

FIG. 28.—Bursting and Reformation of Elastic Skin on Boiling Molasses.

only to *re-form again* and repeat the eruptive process. The diaphragm (G') in the Analogue, bulges out as the pressure of the fluid increases, into a balloon-shaped form as shown in Fig. 28, and finally bursts, after which it is drawn into the aperture again by the cohesion of its own particles, and re-forms itself in the same way, as the viscid bubbles on the boiling molasses. The chambers of fluid ($e'-e''$), are prolonged into tubes which are joined at their extremities ($e'-e''$), by the spiral tube (S').

The current from the induction coil (A), is prevented from flowing through the solenoid (S), by the insulation of the walls of the glass jars ($d-d$). Insulating plates, such as glass and rubber, while resisting the passage of a *continuous current* of

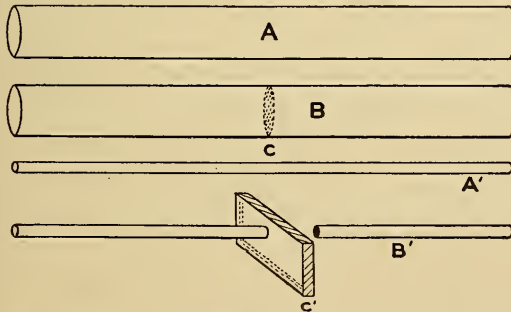

FIG. 29.—A, Pipe Open for Passage of Air. B, Pipe Closed with Elastic Diaphragm, (c). A', Continuous Copper Wire. B', Same Wire Cut at Center and Glass Plate, (c'), Interposed Between the Cut Ends.

electricity, readily transmit *Alternating Currents of High-frequency* (i.e., *Electrical "Oscillations,"* or *"Vibrations"*). In order to understand this phenomenon, let us consider the two metal pipes $A-B$ in Fig. 29; these pipes are exactly similar except

that B is divided into two equal compartments by the elastic diaphragm (C). (A') represents a length of copper wire. (B') represents the same wire interrupted or divided into two parts by the glass plate (C'). A current of air, such as that used in the pneumatic tubes in department stores would flow readily through an open tube, as (A), but would be absolutely stopped in attempting to flow through (B), by the diaphragm (C). Suppose we speak into one end of (A), the voice will be readily heard at the opposite end; the tube (B) would conduct the voice in a similar manner, the elastic diaphragm (C) transmitting the *vibrations* or *sound waves*, although preventing the *actual passage of air* between the two compartments of the tube (B). In a similar manner, a continuous current of electricity, which is analogous to the stream of air in the pneumatic tube, while readily passing through the wire (A') is stopped in (B') by the insulating glass plate (C'); while an alternating current of high frequency, which is analogous to a series of *sound waves*, readily flows through the entire length of (B'); there is no actual passage of "*Electrons*" between the two halves of (B'), but the "*electrical oscillations*" are transmitted by the vibrations of the glass plate (C'), just as the sound waves in (B) set up vibrations in the diaphragm (C) which, in its turn, produces similar sound waves in the second half of the tube (B).

If the student will learn to conceive of the High-frequency Currents as *Vibrations* rather than as actual *streams of electrons*, he will readily comprehend many of their peculiar and apparently paradoxical phenomena. In the analogue, Fig. 27, the rubber diaphragms ($d'-d''$) represent the glass walls of the *Leyden Jars* ($d-d$). Imagine the piston in the left-hand cylinder (b') to be gradually pushed down by means of the lever (L), which causes a corresponding upward movement of the piston in the right-hand cylinder (b''); the fluid in the left-hand compartment (c') will be *compressed*, causing a bulging of the diaphragm (d') in the direction of the Solenoid or spiral tube (S'), and also distending the friable diaphragm (G') into the form of a spherical bag, projecting into the right-hand compartment (c''); as the pressure of the fluid in the latter compartment is decreased by the upward movement of the piston (b''), the corresponding

elastic diaphragm (d''), will be distended in an upward direction as shown in the figure. As the difference in pressure increases, the bulging diaphragm (G'), reaches a point at which it suddenly ruptures or breaks down, and as it does not immediately re-form, a temporary channel of communication is established between the compartments $C'-C''$, and the water rushes through in the direction of the arrow—its motion being increased by the pressure of the distended diaphragms ($d'-d''$), in their return to a neutral position. By the time this point has been reached, however, the water flowing through (G') from left to right, *acquires momentum*, which causes it to *pass* the point of equilibrium, thereby distending the diaphragms ($d'-d''$) in a direction opposite to that which they occupied in the first instance. The friction of the water against the sides of the compartments prevents or retards its flow to some extent, so that the diaphragms ($d'-d''$) are distended to a lesser degree than in the first instance. (See dotted lines.) The water again comes to rest, is again impelled in its original direction by the action of the elastic diaphragms—again passes the neutral point, and in this way oscillates back and forth like a swinging pendulum and finally comes to rest. At this point the diaphragm (G') re-establishes itself in the form of an elastic membrane separating the two compartments, and when the lever (L) causes the piston to again act on the fluid, it again distends into a bag, ruptures and inaugurates a *second set* of gradually diminishing oscillations of the fluid. By means of the elastic diaphragms ($d'-d''$), these oscillations are communicated to the fluid in the spiral tube (S'), which, by its added momentum, tends to *prolong* or *increase the duration* of each *set* of oscillations, although *lowering* or *lessening* their *frequency*, or *rate of vibration*. Two tubes ($f'-f''$), which are attached at either end of the spiral (S') are united by a chamber divided into two compartments ($C'-P'$) by an elastic diaphragm (K'). Oscillations of the fluid in the spiral (S') will cause corresponding movements in the compartments ($C'-P'$), the diaphragm (K') vibrating in unison with them. The frequency, or number of oscillations of the fluid in a minute or second, depends upon the *amount of water displaced or moved* from one compartment to the other, before the plastic diaphragm (G') bursts or is

ruptured by the unequal pressure transmitted to the fluid by the moving pistons. The number of oscillations in each group—*i.e.*, the number following each breakdown of the diaphragm, depends on the size and length of the oscillatory circuit, or, in other words, upon the *amount of friction* which the water meets with, in the circuit formed by ($c'-c''$) and (S'). If the spiral (S') is formed of a number of feet of small pipe, the friction which it offers to the water will retard the velocity of the latter and prevent its acquiring momentum; in consequence of which the

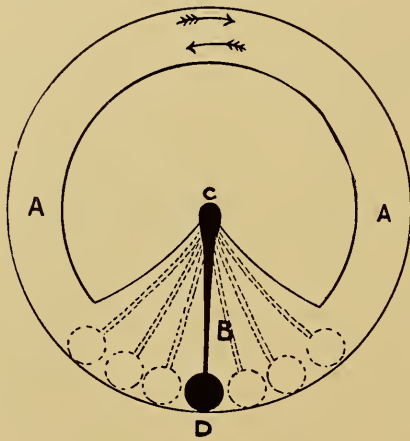

FIG. 30.—Sir Oliver Lodge's Hydraulic Analogue.

A, A, Annular Trough Filled with Fluid.
B, Flat Steel Spring Fixed at C. D,
Metal Ball or Weight Attached to the
End of Spring, B.

current, or flow, will cease as soon as the diaphragms ($d'-d''$) have returned to their normal, flat condition; in other words, there will be but a single, unidirectional flow, or surge of the water for every rupture of the diaphragm (G'). In studying the production of the High-frequency Current in the *d'Arsonval* Apparatus (Fig. 27), we may compare the Electricity sent out from the induction coil (a) to the movement of the water produced by the strokes of the lever (L); as the pressure

increases in the jar (d) and is correspondingly lowered in the other jar, the air separating the terminals of the spark-gap breaks down at (G), forming a *conducting bridge* which temporarily allows the electricity stored up in the two jars to surge back and forth in a series of oscillations *exactly* similar to those of the water which follow each rupture of the diaphragm (G') in the analogue. If the electrical resistance of the solenoid (S), be considerable, there will be but a single impulse of Electricity instead of a series of oscillations; just as the increase in the resistance of the pipe (S') retards the motion and suppresses the oscillations of the water in the analogue. The increase in the number of turns of wire

in the solenoid (S), (provided the wire be of large size and low resistance), *prolongs* or *increases the duration* of each set of oscillations, at the same time slightly lowering their *frequency*, or *number per second*; the *frequency* of oscillations is *primarily* determined by the *size*, or *Capacity of the condensers*; the *inductance* (corresponding to the number of turns in the solenoid), increasing the *number*, but slightly lowering the *frequency* of oscillation, as above stated. The rapidity with which the oscillations of each group *die out* depends upon the *resistance* of the circuit; a *High Resistance* dampening or suppressing *all* the so-called *Secondary Oscillations*, leaving only a single *Primary Impulse*.

Sir Oliver Lodge compares a High-frequency Apparatus to a flat steel spring, fixed at one end in the side of a vessel, its opposite end which bears a metal ball, being free to vibrate in the liquid with which the vessel is filled. (See Fig. 30.) The length and elasticity of the spring represents the capacity of the condenser, and determines the frequency of its vibrations or oscillations. The addition of the metal ball increases the length of time in which the spring remains in a state of vibration, while somewhat diminishing the vibratory frequency. The ball is, in other words, analogous to the *inductance* of a High-frequency Circuit. The *thickness* or *viscosity* of the fluid in which the spring vibrates, represents the resistance of such a circuit; in a light fluid like ether, the spring, if bent back and suddenly released, would vibrate a long time before coming to rest, while a viscid fluid like molasses or tar would cause the vibrations to cease almost immediately.¹

The explanations and analogies cited in the preceding pages elucidate the relationship between the essential factors involved in the production of High-frequency Currents; namely, *Capacity*, *Inductance* and *Resistance*. Mathematically stated, if the Resistance (R), be greater than the square root of four times the

¹The skilled electrician or learned specialist who peruses this book will doubtless criticise the writer for his verbosity and seemingly unnecessary repetition, but he is reminded that facts, which from his standpoint are of a simple and obvious nature, may be extremely difficult of comprehension for the student who is just commencing the study of electricity, or by the physician desiring to obtain a practical idea of the elements of modern Electrotherapeutics. As this volume is intended both as an elementary textbook for the novice as well as a work of reference for the advanced specialist, the necessity for these few words of explanation will be readily understood.

Inductance (L), divided by the capacity (C), the discharge will be a *single unidirectional impulse*. Conversely, if the Resistance is less than the above-mentioned quantity, the discharge will be of an *oscillatory nature*.

If $R > \sqrt{\frac{4L}{C}}$ discharge is non-oscillatory

but if $R < \sqrt{\frac{4L}{C}}$ discharge is oscillatory.

With zero resistance the oscillations would continue indefinitely, but as every circuit *must* have *some resistance*, the oscillations following each condenser discharge successively decrease in amplitude and ultimately die out altogether. The ideal condition in a Therapeutic High-frequency Apparatus involves the use of a circuit in which resistance is reduced to a minimum, and the capacity balanced by a suitable inductance. In order to obtain this condition the condenser should be charged by a relatively heavy current at a comparatively low voltage; the Spark-gap must be short, yet must be constructed so as to prevent the formation of an arc between its opposed surfaces. Under such conditions the interval between the termination of one set of oscillations and the beginning of the next, is so small as to be practically negligible, and we consequently have a true "*Alternating Current of High-frequency*." The writer determined the above facts several years ago, by a series of clinical tests of currents from a number of different types of High-frequency Generators, and has embodied the results in his Improved High-frequency Apparatus which he employs in his practice at the present time. In all apparatus of the *d'Arsonval* type, using *Ruhmkorff* Coils, the spark-gap has, of necessity, a very high resistance, varying from one to three inches in length; and it is evident that relatively great intervals exist between succeeding sets of oscillations. This is demonstrated experimentally by the sound at the Spark-gap, which resembles the noise of a "Watchman's rattle," while the condenser discharge of the author's apparatus emits a continuous *Musical Note* or *Tone*.

Many physicians believe themselves to be using High-frequency Currents, when in reality they are employing *Pulsatory Condenser*

discharges. The "*Static Induced,*" and the "*Static Wave Current,*" devised by *Dr. William James Morton* of New York, exemplify the above statement. These currents consist of single short pulses, separated by relatively enormous intervals; graphically represented, if the distance on the "*time-line,*" or "*abscissa,*" corresponding to the rise and fall of a *single current impulse* be *one inch,* then, the distance to the *next impulse,* as represented on the *Abscissa,* would be *seventeen and one-half miles!*

CHAPTER VI

EUROPEAN TYPES OF HIGH-FREQUENCY APPARATUS

BEFORE attempting a description of the various types of apparatus at present on the market, it will be necessary to briefly review the different methods for the generation of High-frequency Currents. Apparatus of the European type, made in

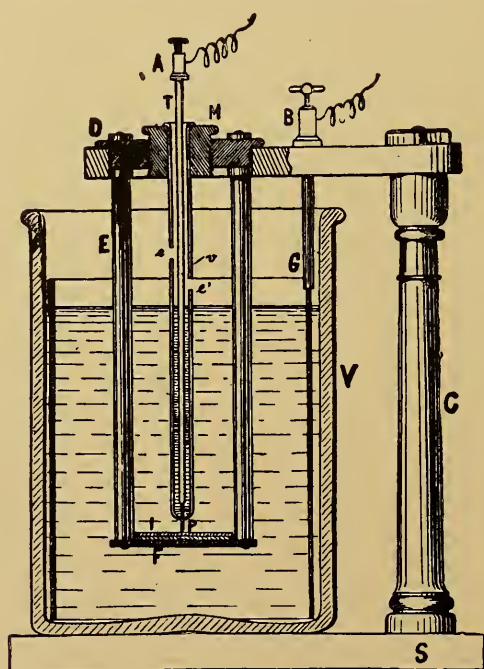

FIG. 31.—Electrolytic Interrupter of Wehnelt. (Williams.)

accordance with the principles of *d'Arsonval* and *Oudin* are used with a *Ruhmkorff* Induction Coil, excited by a *Continuous, Unidirectional, Incandescent Light Current*. (Fig. 31.) In order to obtain the inductive impulses, an "Interrupter" must be employed; this may be either *electrolytic*, or *mechanical*. If an

Alternating Electric Light Current is to be used, a "*Rectifier*," or "*Valve*," may be employed, to cut out the alternations in one direction. (Fig. 32.)

The result is a *Pulsatory, Unidirectional Current* which may be used with practically the same results as those obtained from the continuous current. If the *Ruhmkorff* Coil is used solely as

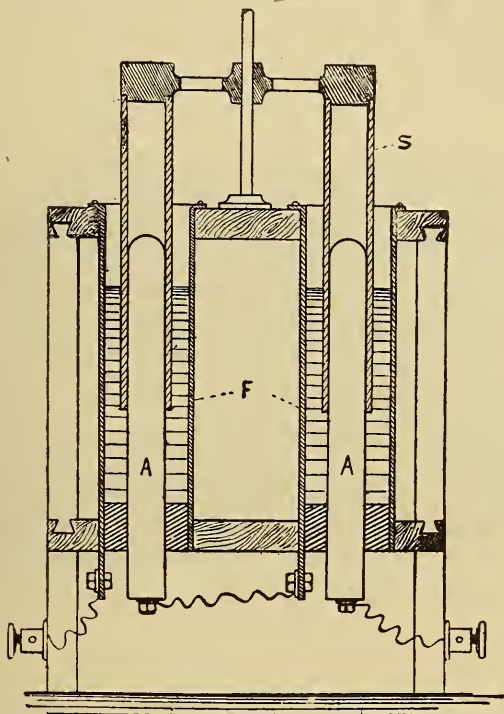

FIG. 32.—Nodon Valve, or Rectifier. (Williams.)

a High-frequency Generator, the rectifying valve may be omitted, but if it is also employed for X-Ray purposes, the current must be made *unidirectional*. In the employment of the High-frequency Apparatus of the American, or *Tesla-Thomson* type, as introduced by the present writer, the conditions are the exact reverse from those above described. Properly speaking the typical *Tesla-Thomson* apparatus can be operated only on an *Alternating Current*; in order to adapt a *Direct Current* for use in this connection, it must be first transformed into an *Alternating*

Current. For this purpose a machine known as a "Rotary Converter" is used. A good Rotary Converter will give out about four-fifths of the energy used to excite it, in the form of an Alternating Current of a somewhat lower voltage. No *Ruhmkorff* Coil, or Interrupter is required for the production of the *Tesla* Currents, both these devices being replaced by an *Alternating Current Transformer* of the "step-up" type; that is one which takes in electrical energy of a certain voltage, and gives it out at a considerably higher pressure. The "Step-up" Transformer is usually permanently incorporated as a part of

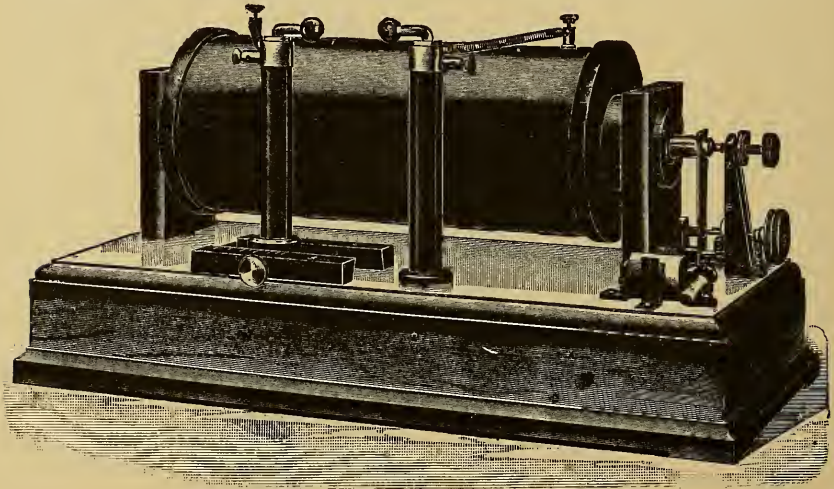

FIG. 33.—Ruhmkorff Induction Coil. (Watson, London.)

the High-frequency Apparatus, whereas the *Ruhmkorff* Coil is an entirely separate and distinct instrument from the *d'Arsonval* solenoid and resonator. With this preliminary explanation we may pass at once to a detailed description of the various standard types of High-frequency Apparatus. We will first consider some of the more prominent forms of European apparatus. As most foreign instruments are designed for use with a *Ruhmkorff* Coil, a short description of the latter device may not be out of place.

The illustrations (Fig. 33 and Fig. 34) show the appearance and construction of the average European *Ruhmkorff* Coil. When used for X-Ray or high-frequency work, however, an

electrolytic or mercury interrupter is usually substituted for the vibrating mechanical break (represented in the figure), which is used only in small portable coils operated by primary or secondary batteries. The *Condenser* (*E-E-E*) which consists of a number of sheets of tin-foil, separated by sheets of mica or waxed paper, is unnecessary when an interrupter of the *electrolytic* type is employed. The function of the condenser is to suppress the "*Extra Current*" *self-induced* in the primary coil,

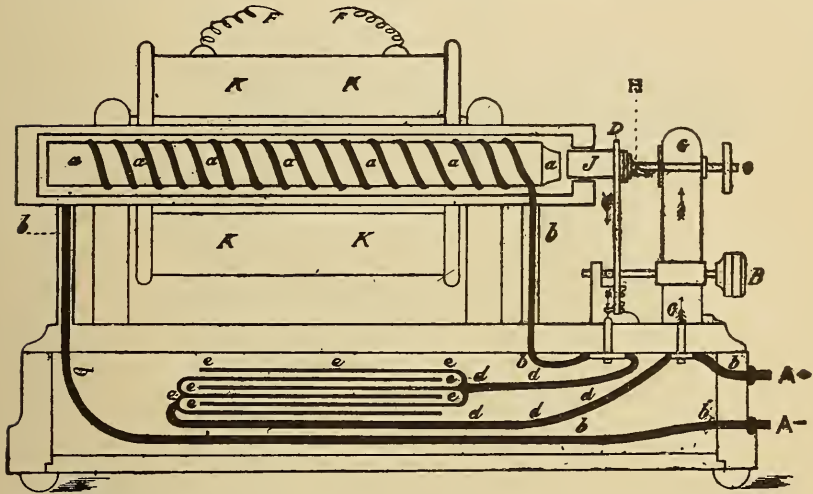

FIG. 34.—Ruhmkorff Induction Coil, Shown Diagrammatically. (Williams.)

and this current is an *important factor* in the operation of the Electrolytic Interrupter. A variety of *Ruhmkorff* Coils, of different makes, are in use at the present time, their construction being practically the same except in minor details. For ordinary X-Ray or high-frequency work, coils having a spark-length of from ten to twelve inches are most generally used. It is possible to operate a High-frequency Apparatus of small size on a six-inch *Ruhmkorff* Coil, but for powerful effects—with the large "*Double Resonator*," of *Dean* for example, it would be necessary to employ a coil of from sixteen to twenty inches sparking capacity. Almost all up-to-date mechanical interrupters employ *mercury* in one form or another. One of the best known is "*The Mercury Jet*" Interrupter, of *Isenthal & Company* (See Fig. 35).

The mercury, forced through a small aperture by a pumping device, forms a fine *metallic jet*, which impinges against the amalgamated surface of a series of *triangular blades*, attached to a rapidly revolving drum. The height, or level of the mercury jet determines the relative length of the "make," and "break."

By means of a *rheostat* in series with the motor which operates the Interrupter, a range of from one hundred and twenty, to twelve thousand interruptions per minute may be obtained.

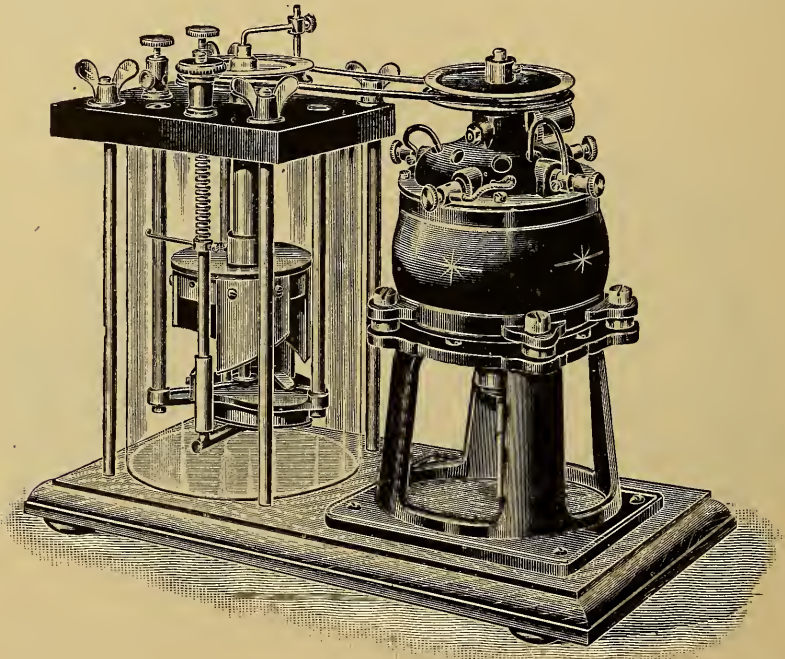

FIG. 35.—Mercury Jet Interrupter. (Isenthal & Co.)

Another type of "Mercury Break" is shown in Fig. 36. A vertical plunger is given a reciprocal motion by a Motor which causes it to alternately dip and withdraw from a cup of mercury, the surface of which is covered with oil. While a number of these interrupters are in use, they are regarded as somewhat obsolete at the present time.

Another very popular and efficient instrument is the "*MacKenzie-Davidson* Interrupter (See Fig. 37). It consists of a

motor, placed in an inclined position; its shaft terminating in a slate disk, bearing two metal contacts, which dip into a dish of mercury at each half-revolution of the motor shaft. The opera-

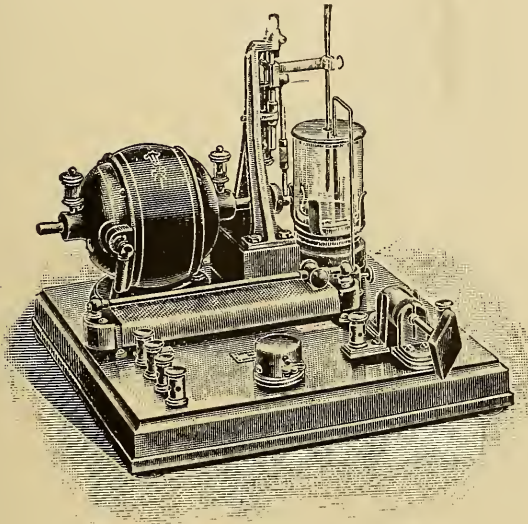

FIG. 36.—Dipper Mercury Interrupter.

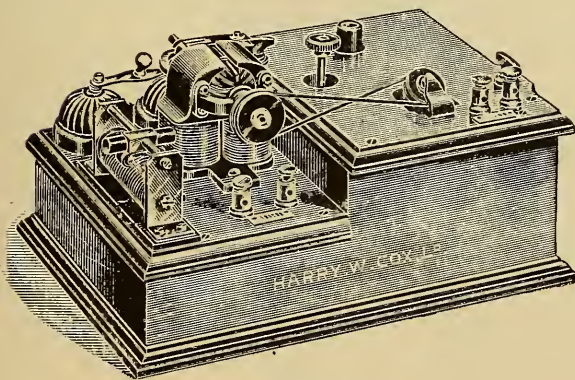

FIG. 37.—Mackenzie-Davidson Interrupter.

tion of this device is obvious; it is one of the best of the foreign interrupters.

The conventional European type of "*Electrolytic Break*" is the well-known interrupter of *Wehnelt*—a simple form of which

is shown in Fig. 38. In a glass jar of dilute sulphuric acid are immersed a lead plate, or "*Cathode*," and a fine platinum wire "*Anode*" which projects for a fraction of an inch into the acid, through a small hole in the lower end of a long porcelain tube. The projecting part of the platinum wire is regulated by a thumbscrew in the cover of the Instrument. The passage of a direct current through this interrupter causes a film of *hydrogen gas* around the end of the wire, thereby *breaking* the circuit;

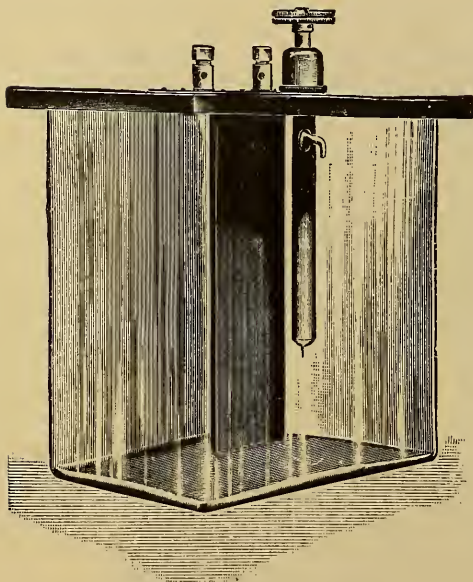

Fig. 38.—Wehnelt Interrupter. (Williams.)

as no condenser is used, the "extra" current—self-induced in the primary of the *Ruhmkorff* Coil—discharges in the form of a bright spark, causing a further recession of the acid from the wire point. The acid almost immediately flows back in contact with the *anode*, and in this way "breaks," and "makes" follow each other in rapid succession. In America this type of interrupter is extensively used, having been greatly improved and simplified

during the last two years. In the European types of High-frequency Apparatus, the *Ruhmkorff* Coil is seldom incorporated with the resonator and solenoid, the oscillating system being generally sold as a separate apparatus—comprising a pair of *Leyden Jars*, an adjustable *spark-gap*, and a *solenoid* and *resonator* usually wound upon the same cylinder, the various parts being assembled on a suitable table, or base. The most popular form is shown in Fig. 39, which is known as the "*Oudin-Dean Resonator*." This model has been extensively copied by manufacturers in all parts of the world. The *resonator* consists

of fifty or more turns of insulated copper wire, about three millimeters in diameter, wound spirally upon a wooden cylinder fifty centimeters high, and thirty centimeters in diameter. The following description of the nature of the "*Oudin Resonator*" is quoted from *Freund's* admirable work on "*Radiotherapy*."

"As forced resonance is more powerful in its effects than free resonance, the resonator was at first attached to one pole of the solenoid of high frequency; the other pole remained free or was connected to the earth. This arrangement, however, was soon modified. It was found that better effects could be produced by connecting both poles with the resonator. A subsequent modification led to the solenoid of high frequency being suppressed and the resonator directly connected with the external armatures of the condensers. The lowest spiral of the resonator was then united to one armature, while a spiral four to seven turns above it was connected to the other armature by an adjustable clip. The resonator was thus divided into

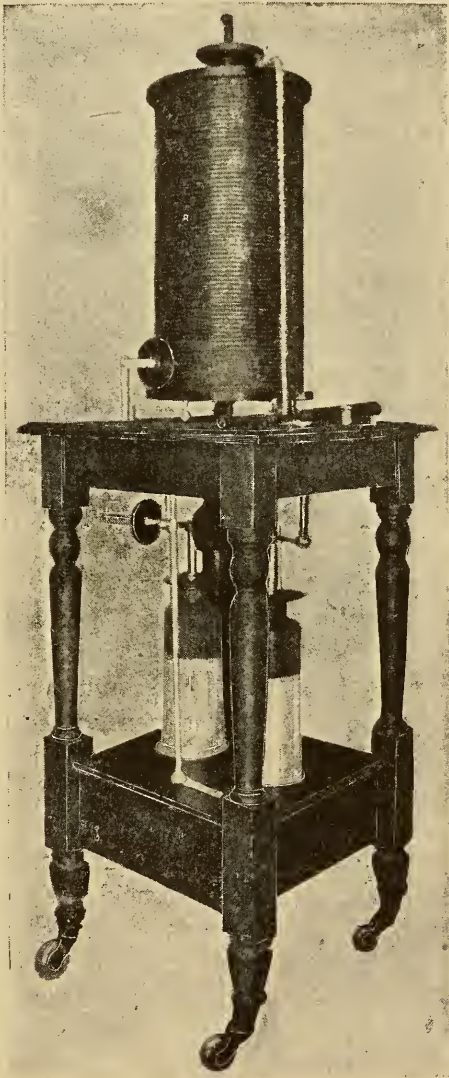

FIG. 39.—Oudin-Dean Resonator.
(Williams.)

two solenoids—a lower and an upper. The lower, or primary solenoid, of small size, consisted of a few turns of wire intercepted between the points of attachment of the two cords leading to the external armatures. In it circulated currents of both high and medium frequency, those of high frequency alone being free to pass into the upper solenoid; for the currents of lower frequency were close-circuited by it. The secondary or upper solenoid was longer, and was traversed by currents of high frequency alone; these by reason of self-induction of the circuit, attained an enormous tension. When the three essential magnitudes—capacity, self-induction and resistance—of the two solenoids were by trial proportioned to one another, the upper spirals of the resonator and its terminal were seen bathed in a lively brush discharge like to that produced by a *Tesla Coil* or influence machine. This effluve is made use of for therapeutic purposes, by connecting the free terminal of the resonator or one of its upper spirals with the wire leading to the electrode.”

Although the caliber of the wire which forms the resonator, does not appear to materially interfere with the production of these resonance effects, yet it has, according to *Oudin* a considerable influence on the physical character of the effluve and spark. A fine wire yields a spark, long, thin, sinuous and scarcely painful, with an effluve as poorly nourished; while with a wire of larger dimensions, both effluve and spark gain in force. This depends on the capacity of the wire rather than its self-induction, for every increase in capacity renders the spark more vigorous and painful.

The manner in which connection was established between the poles of the primary solenoid of the resonator and the external armatures of the condensers next attracted attention. It was recognized that the nature of the arrangement that exists for this purpose largely influenced the adjustment of the two solenoids and the regulation of the effects produced. The crude and unsatisfactory method in which the spring-clip or contact-hook is used to connect the wire from the external armature with the desired spiral soon gave place to others which allowed more perfect regulation and adjustment to be made without in any way interrupting the circuit. *Ducretet* and *Bonnetti* invented

an apparatus in which a grooved contact slip is made to revolve about a fixed resonator, and thus establish contact with the spirals; while *Radiguet* caused the resonator itself to rotate before the stationary contact point. Both these methods allow of a perfect graduation of effects and an easier adjustment of the solenoids to each other, without any interruption of contact.

The resonators above described, however, are only suitable

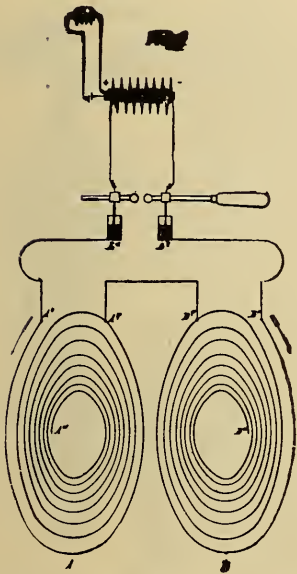

FIG. 40.—Resonator of Lebailly and O'Farril.

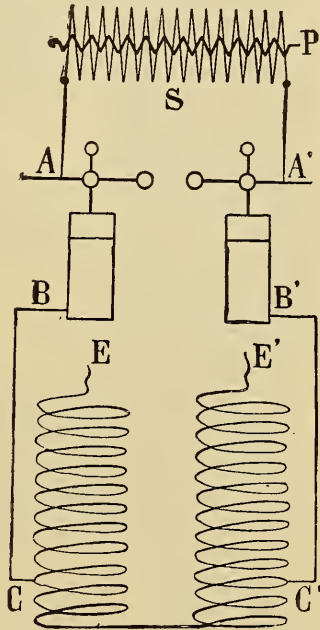

FIG. 41.—Rochefort's Bipolar Resonator. (Freund.)

for producing unipolar effects. If double effluvation is to be practiced, the apparatus of *Lebailly* and *O'Farril* or that of *M. Rochefort* must be resorted to. (Fig. 40.)

In the former, the primary solenoid is centrally situated, the external armatures being connected with two intermediate spirals. This creates two secondary solenoids which are situated one on either side of the primary and allows of bipolar applications to be made by connecting the wires leading to the electrodes with the free outer terminals of these two solenoids."

Although the apparatus is an improvement on the unipolar

resonator of *Oudin*, still it is not always easy to equalize the current density at the two poles, and for this reason that of *M. Rochefort* is preferred.

In the *Rochefort* model (*vide* Fig. 41) four *Leyden Jars* are employed. These are divided into two batteries connected by their internal armatures with the secondary terminal of an induction transformer or spark-coil. The external armatures

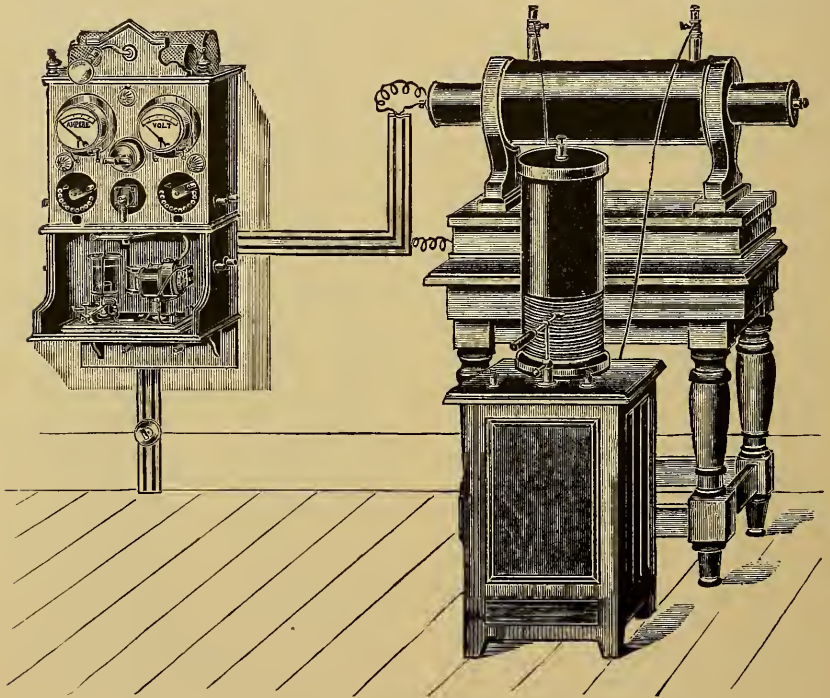
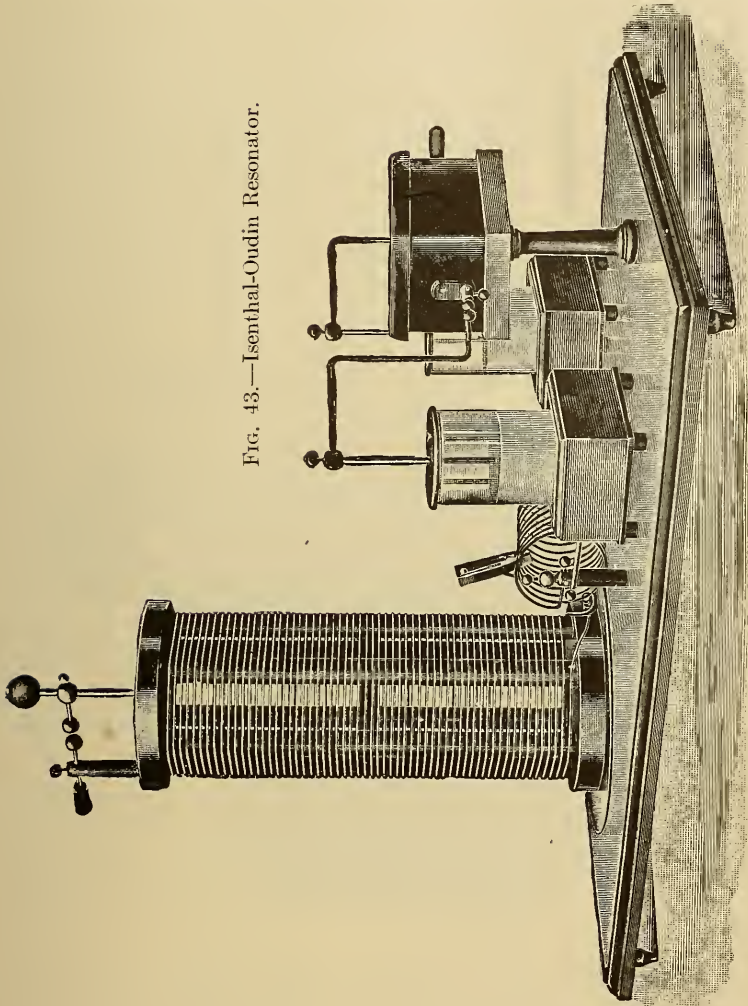

FIG. 42.—Upright Solenoid on Cabinet. (Williams.)

are connected with two separate resonators, those of each battery being connected, the one with the lower terminal of one resonator, the other with the uppermost spiral of the primary solenoid of the other resonator. When carefully adjusted the density of the current traversing each of the secondary solenoids is equalized; and being of opposite sign, double effluvation can easily be practiced and the effects produced readily controlled.

The position of the resonator in the apparatus of different makers calls for a few remarks. In some apparatus, as in Fig.

FIG. 43.—Isenthal-Oudin Resonator.



42, the solenoid stands upright on the cabinet enclosing the condensers and spark-gap; in others; as in Fig. 43, it is permanently connected with the condensers; in others again the resonator is horizontally placed so as to allow its inclusion in a cabinet; and lastly, it may be inverted and fixed by its base to the bottom of the baseboard of a High-frequency Table. As there is no special advantage gained by any of these peculiar arrangements beyond the mere matter of saving space, these

eccentricities call only for a passing notice. Much more important, however, is the arrangement for graduation. The crude method of regulation by the contact clip must only be mentioned to be condemned. The regulation by means of a revolving cylinder running on rubbered tires, whose movements can be graduated by the movement of a handle, is the one most to be commended. Not less worthy of mention is the resonator revolving around a fixed contact in which adjustment is effected by revolving the solenoid by means of the insulating spokes fixed to the disk at its base.

Guilleminot's Spirals.—In resonators formed of wire wound into a helix or solenoid, the energy of the electrostatic field developed by the inducing spirals is only to a very limited extent utilized in the production of induced currents. For the form of the resonator of *Oudin* does not permit the powerful oscillatory field, created in the vicinity of its spirals, to be employed in generating bipolar currents. *Guilleminot* has, however, by changing the form of the resonator from a helix to a spiral been able to utilize the energy of the field in producing bipolar effects. The results of his experiments were published in 1901. His resonator is so constructed that the excitation is caused by a single turn, the outer one, which acts as the inducing spiral. (See Fig. 10.)

In practice the adjustment is not made by altering the coefficient of self-induction of the inducing spiral. This is kept constant and a subsidiary coil of thick wire, with an apparatus for regulating its self-induction, is introduced into the exciting circuit.

The spiral is formed of eighteen turns of wire, 2 mm. thick, held in place by radii of catgut. The smallest circle has a diameter of 33 cm., and the largest a diameter of 83 cm. The interspaces between the successive turns increase in width toward the periphery, since here the difference of potential between successive turns is much greater. The various forms of exciter used in applying High-frequency Currents in medicine are attached to the center of the spiral.”

For further details regarding the construction and use of the various forms of spiral resonators the reader is referred to the

notes on instrumentation compiled by *Dr. Clarence A. Wright*, and published as an appendix to *Freund's "Radiotherapy."*

For general treatment with Low-potential, High-frequency Currents of *d'Arsonval* when especially profound effects are desired, the powerful apparatus shown in Fig. 44 is employed.

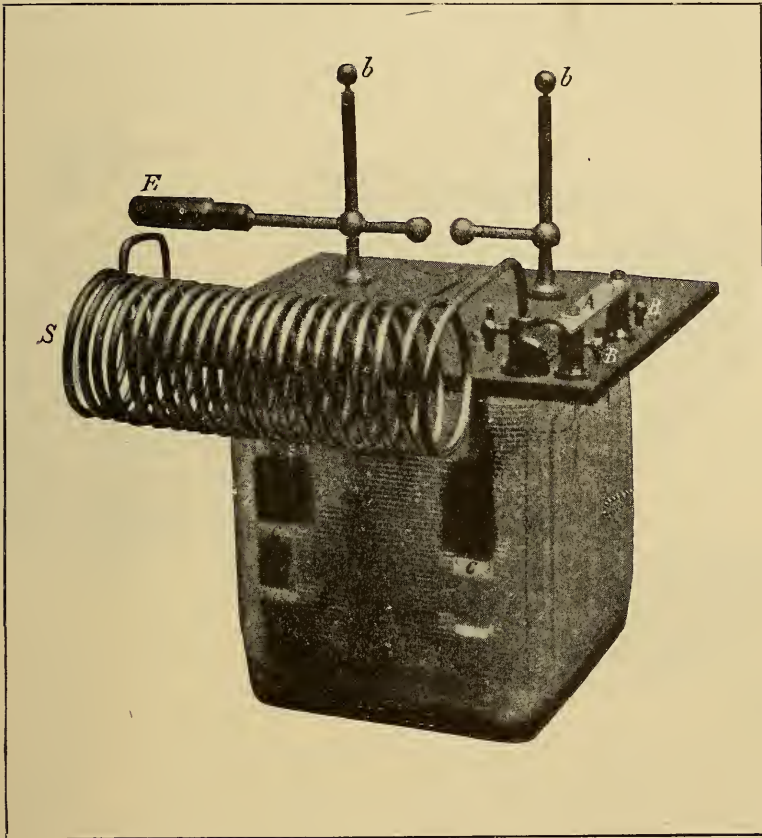

FIG. 44.—Gaiffe's Oil Condenser and Heavy Solenoid.

It is manufactured by *Gaiffe* of Paris from the original designs of *d'Arsonval*, and consists of a multiple glass plate condenser, immersed in oil, provided with an adjustable spark-gap, and a solenoid consisting of twenty-one turns of copper wire. In the above apparatus we have a departure from the usual European type, in that the condenser consists of alternate plates of glass

and tin-foil, while in other forms of resonators and solenoids, *Leyden Jars* are employed. There are two other types of European apparatus in which plate condensers are employed—the first shown in Fig. 45, is known as “*Gaiffe’s Bipolar Resonator*,” and is in reality a form of the *Tesla-Thomson* apparatus.

The solenoid is not connected with the resonator, the currents in the latter being induced by the *rapidly alternating Electrostatic Field* surrounding the solenoid. *Discharges* of High-frequency and High-potential may be obtained from either terminal of the

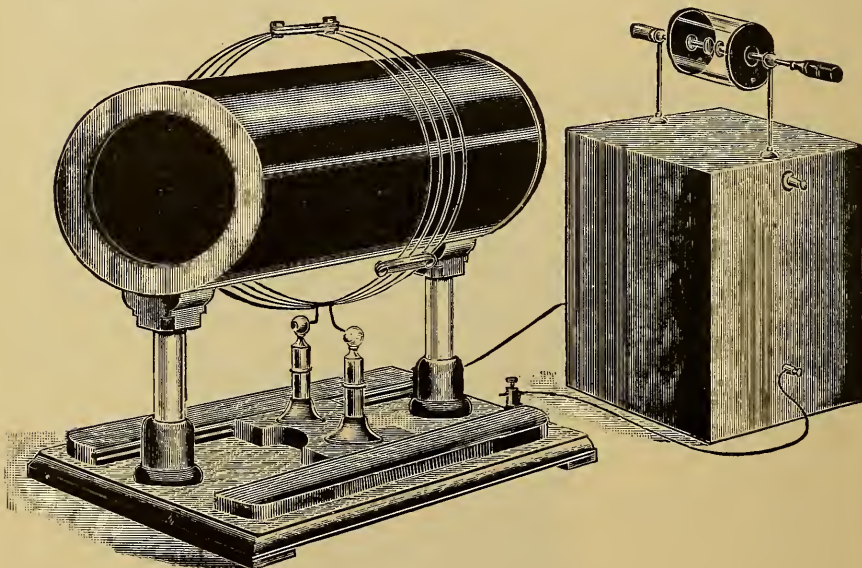

FIG. 45.—*Gaiffe’s Bipolar Resonator*.

resonator, while true High-frequency *Currents* are produced when the patient is connected with *both* terminals. This apparatus is usually operated from a *Ruhmkorff* Coil excited by a “*Direct*” incandescent light current. Alternating currents which are extensively used in America and which are peculiarly adapted for exciting High-frequency Apparatus of the *Tesla-Thomson* type, have only recently been introduced into the different European cities. There is every indication, however, that currents of the alternating type will entirely supersede the “*Direct*” continuous current within a few years. Recognizing this fact, *Messrs. Gaiffe* of Paris have recently introduced an

extremely efficient High-frequency and X-Ray Apparatus, designed for use on the *alternating current*, without the necessity for interrupting or rectifying the latter. As this instrument is being very generally employed by European specialists, and as it also illustrates the differences in construction and operation between European and American High-frequency Apparatus of the “*closed-circuit transformer*” type, it has been deemed advisable by the author to quote the following detailed description from *Belot’s* work on “*Radiotherapy*”:

“This new apparatus makes it possible to utilize an ordinary alternating current, without an interrupter, either for the production of X-Rays or for High-frequency Currents. Hitherto, if we wished to employ an alternating current, we had to use a *Ruhmkorff* Coil—*i.e.*, a transformer with an open magnetic circuit, supplied with a special form of interrupter. The choice of this lay between an electrolytic interrupter and a self-regulating interrupter of *Villard*, and it is well-known how difficult it is to regulate either of these instruments.

“It is true that a few years ago a transformer with closed magnetic circuit was made, and that this was used without an interrupter; but, though theoretically perfect, this apparatus rapidly deteriorated with use.

M. Villard was the first to adopt this arrangement. The rapid breakdown of the end coils of the secondary was due to the reflected Hertzian waves.

“To guard against these accidents we were obliged, even when working with High-frequency Currents, to employ comparatively low tensions of 15,000 to 20,000 volts. The results obtained were not satisfactory, and even then the transformers broke down. With X-Rays, where a higher tension was required, the appa-

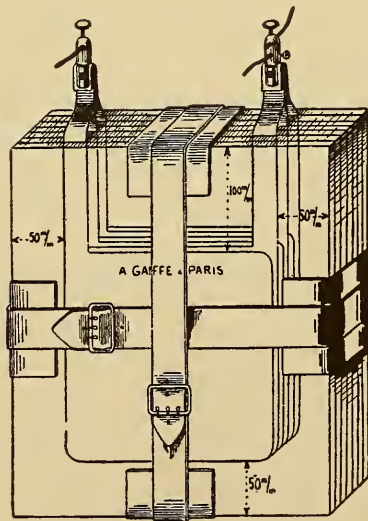

FIG. 46.—Condenser. (From Belot.)

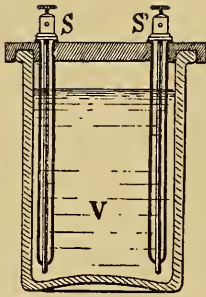

FIG. 47.—Liquid Resistances. (From Belot.)

ratus soon became useless. The transformers were soon abandoned, and the ordinary coils continued to be used. These are subject to the same dangers, but on account of their smaller output, they deteriorate more slowly. Thus one of their greatest imperfections has added to their longevity.

“The irregularities of the interrupter, of whatever form, render impossible even an approximate estimate of the output of the secondary. The great novelty in *Gaiiffe's* apparatus is a protective arrangement, which has already been presented to the Académie des Sciences by *d'Arsonval*. This absolutely prevents the breakdown of the instrument by arresting the reflected Hertzian waves. It is composed of various condensers and resistances.

“Their arrangement and magnitude are determined by considerations of the insulation of the coils of the primary, and the nature of the High-frequency Waves which are required.

“These improvements have been so successful that the installation can be employed for all forms of practical work—the condensing couch, the effluve, resonance, bipolar radiations or X-Rays.

“The apparatus consists of an ordinary transformer, with closed magnetic circuit, receiving an alternating current of 110 volts, which it converts into one of 60,000 volts.

“The protective arrangement is threefold. Firstly, there is a series of condensers arranged between the poles of the secondary (Con., Fig. 46). Secondly, liquid resistances are introduced into the circuit, on either side of the transformer (Resist., Fig. 47). Finally, other condensers are introduced, between the liquid resistances and the tube (C., Fig. 48). These latter are the *d'Arsonval* High-frequency Condensers.

“They have the further advantage of insulating the operator, and thus prevent any danger from his accidentally touching one of the poles. At the same time they are a convenient method of limiting the current which passes through the tube.

“The whole apparatus is enclosed in a glass-fronted cabinet, which obviates all danger of accident. The top is surmounted by a marble slab, to which are affixed the voltmeter and ampere-meter, for measuring the primary current, a rheostat resistance interposed in the primary current, and the terminals for the high-tension current.

“The parts are so arranged that the apparatus may be used at will for high frequency or X-Rays by simply removing the *Villard* valves and interposing a spark-gap in their place.

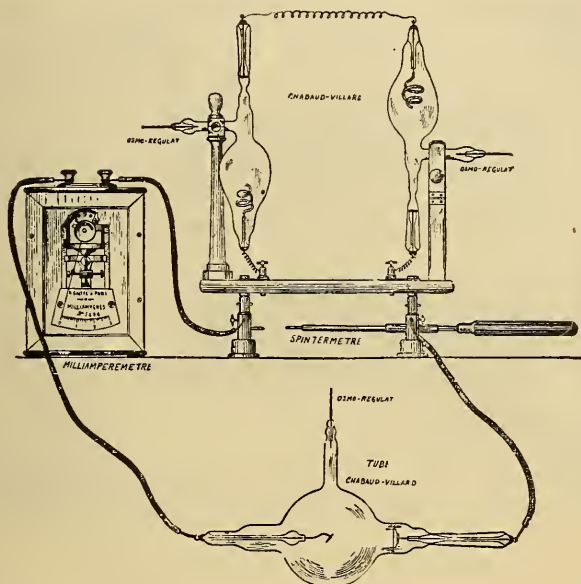

FIG. 48.—Arrangement of Valves, Tube and Meter.
(From Belot.)

“This apparatus is free from danger and easily adjusted. The current may be regulated by merely moving the handle of the rheostat. It will give much greater power than any which can possibly be required at the present time. When the apparatus of distribution has been perfected, and more power is required it will only be necessary to increase the capacity of the condensers, which act as taps to regulate the output. The apparatus is, moreover, always ready for use; there is no trembler to get out of order, no mercury or petroleum to require constant

renewal, and no noise to disturb the patient and wear out the nerves of the operator.

“Let us now inquire how it is adjusted for producing X-Rays. The current should pass in one direction only. As the alternating current produced by this transformer changes its polarity with each oscillation, one series of waves must be absorbed before reaching the tube. For this purpose two *Villard* valves

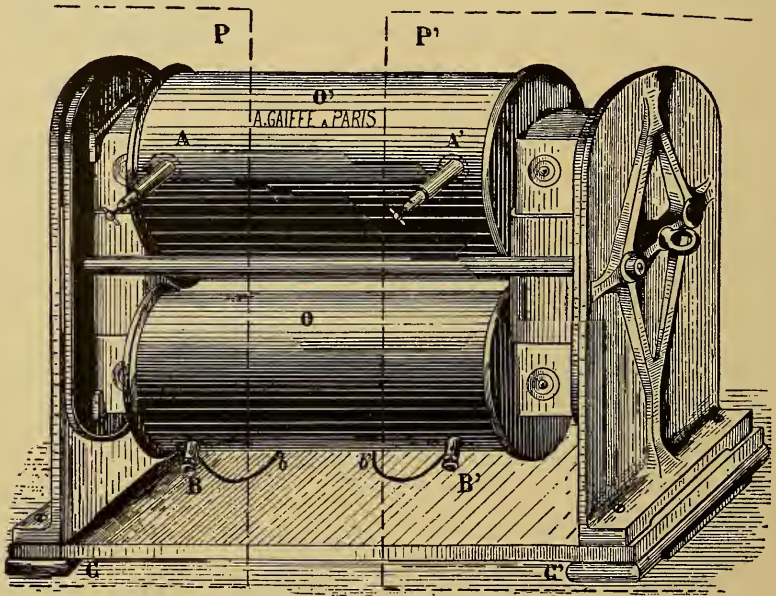

FIG. 49.—Transformer. (From Belot.)

($P-P'$ Fig. 54) are inserted in parallel with the tube in the manner indicated by *Villard* himself.

“The discharge through the *Roentgen* Tube is perfectly regular, the fluorescent screen being as steadily illuminated as when a static machine is in use. The means for complete adjustment is afforded by the rheostat in the primary circuit.

“There is theoretically no limit to the power which can be obtained by the use of this apparatus. As soon as the construction of the tubes have been sufficiently improved, with a view to increasing the intensity of the rays, the length of exposure in radiography and the time of application in radio-

therapy will be greatly decreased. At present the intensity of the X-Rays obtainable is limited by the fear of injuring the tubes.

“This installation may be arranged to obtain stereoscopic radiographs. Two *Roentgen Tubes* may be illuminated at the same time by using one of the two series of waves for each tube.

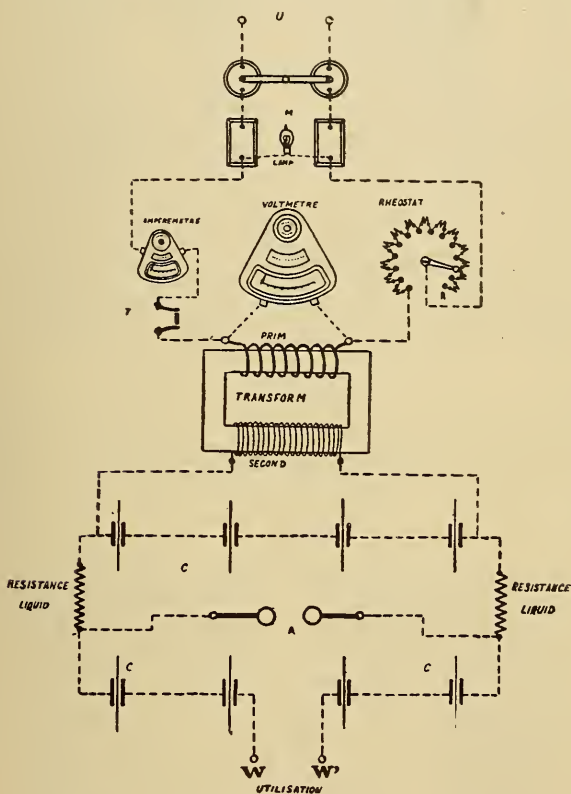

Fig. 50.—General Diagram. (From Belot.)

“An automatic shutter, whose movement synchronizes with the interruptions of the current, is required. Such a shutter has been invented by *Villard*.

“This apparatus may be also used with a continuous current. A commutator converts the continuous into an alternating current. By this means we get rid of the interrupter and the *Ruhmkorff* coil, both of them very imperfect and unsatisfactory

instruments. The utilization of instruments for measurement is thus greatly facilitated. It may be objected to this form of

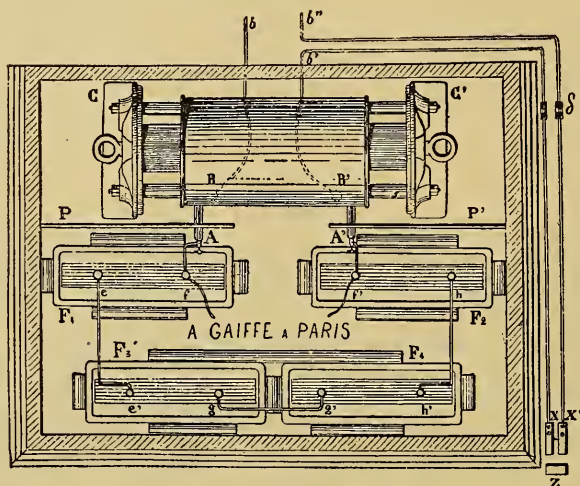

FIG. 51.—Top Shelf of Cabinet. (From Belot.)

installation that, since it is supplied by the alternating current, it will be influenced by any variation in the mains. The only possible variations, however, are changes of potential and changes in the rate of alternation.

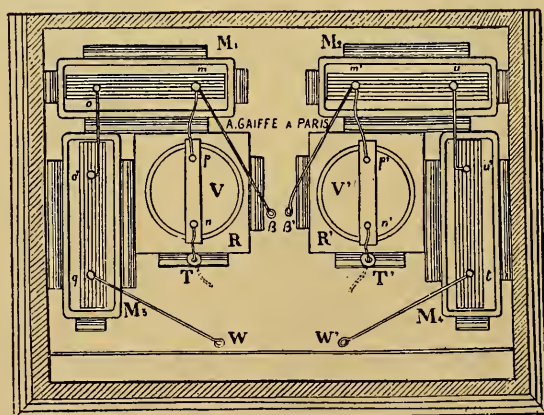

FIG. 52.—Lower Shelf of Cabinet. (From Belot.)

“Neither of these ever varies by more than one per cent., and their effect is therefore negligible. This is quite otherwise if

ordinary current converters are used. These depend for their effect on synchronism with the current, and are therefore much more sensible to brief variations in the main.

“This installation is equally adapted for high-frequency work.

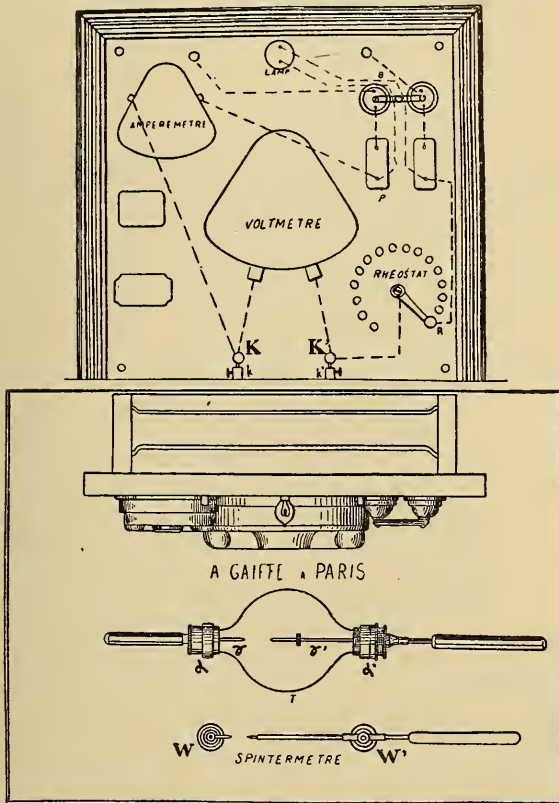

FIG. 53.—Springs and Contact Plate. (From Belot.)

It is only necessary to remove the *Villard* valves and insert the spark-gap in order to adjust it for this purpose.

“As we have already stated the whole of the apparatus—transformer, regulators, condensers and spark-gap—is arranged in a cabinet. Within the cabinet are the coils of the transformer, as shown in Fig. 49. These should never be used outside the case.*

* Radiotherapy, by Dr. J. Belot (Rebman Company, New York).

“ In Fig. 50, we give a general diagram of the installation, and Figs. 51 and 52 show the arrangement of the two shelves of the cabinet, with the connection of the transformer, condensers, resistances, etc.

“ Fig. 53 also shows the springs, $X-X'$, and the contact plate. The latter is attached to the door, and thus breaks the circuit

whenever it is opened. All danger from electric shocks is thus obviated, since the apparatus cannot work unless the door is shut. All dangerous apparatus is thus out of the way of the operator.

“ The safety-fuses, measuring instruments, and regulating apparatus are attached to a marble slab on the top of the cabinet, as shown in Fig. 54.

“ This new installation of *Messrs. Gaiffe* seems to meet all theoretical requirements. We have had many opportunities of proving both its safety and its adaptability to practical conditions.”

In addition to those already described, a large variety of High-frequency Apparatus of the *Oudin-d'Arsonval* type has been placed on the market by the European manufacturers. Of these may be mentioned the outfit shown in Fig. 55, made by *Max Kohl* of Chemnitz,

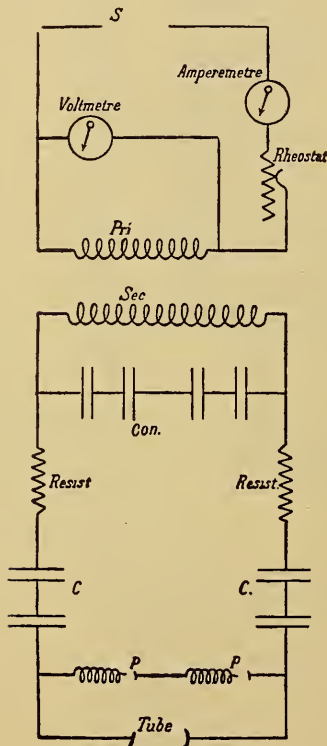

FIG. 54.—Regulating Apparatus.
Arrangement of Transformer.
(From Belot.)

in which the *Ruhmkorff* Coil is conveniently located in the lower part of a handsome cabinet, the two upper compartments being occupied, respectively, by the coil terminals, interrupter and meters, and by the High-frequency Apparatus proper; the latter being a small solenoid, separate from the resonator, to which it is connected by means of a spring clip and flexible wire. This outfit is the most frequently em-

ployed form among the German specialists, while the upright type of resonator, as shown in Fig. 56, is preferred in England and France.

As has been previously stated, the development of High-

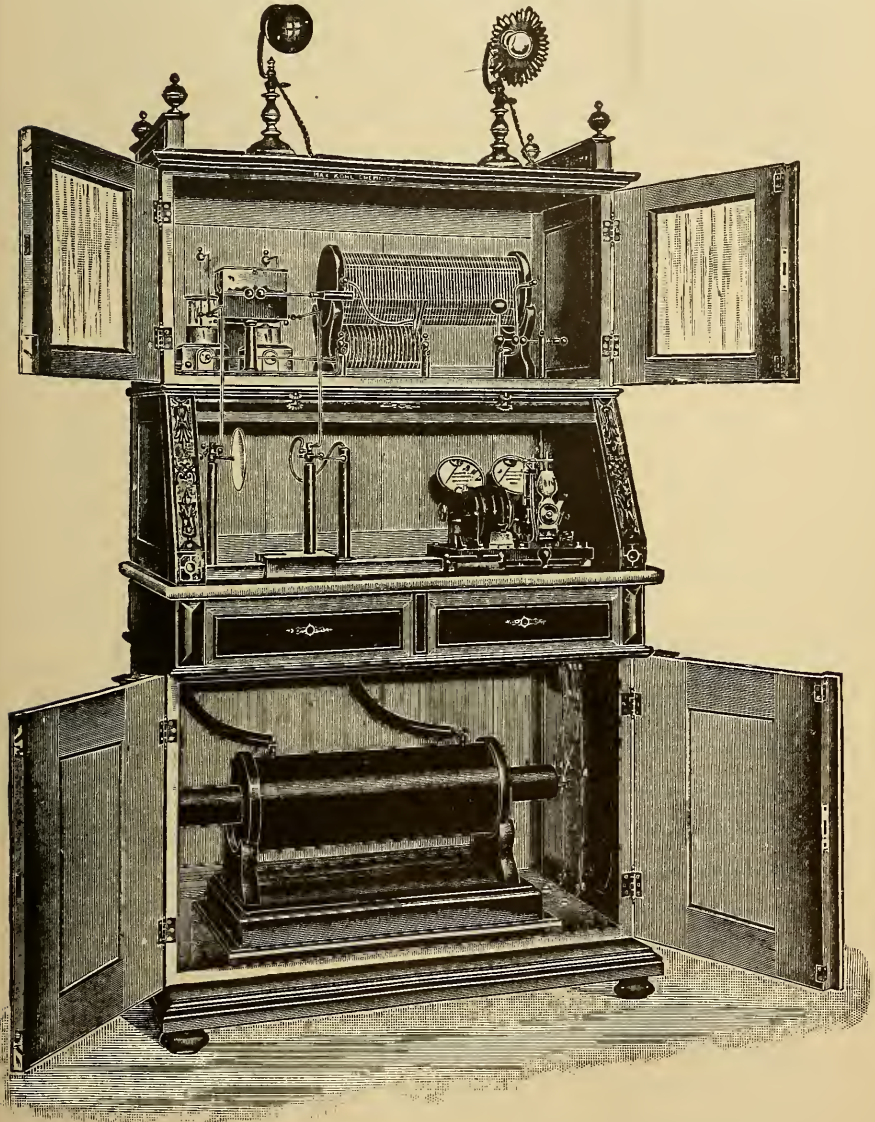

FIG. 55.—Isenthal's Complete High-frequency Apparatus. (Williams.)

frequency Therapeutics in America, began with the work of the present writer in 1896. During the first four years of his investigations, which were carried on upon entirely different lines from those followed by *d'Arsonval* and his colleagues, he completed the designs for the first practical Therapeutic High-frequency Apparatus introduced to the American profession. It had been used for several years in his private practice, before the widespread interest in its remarkable therapeutic effects

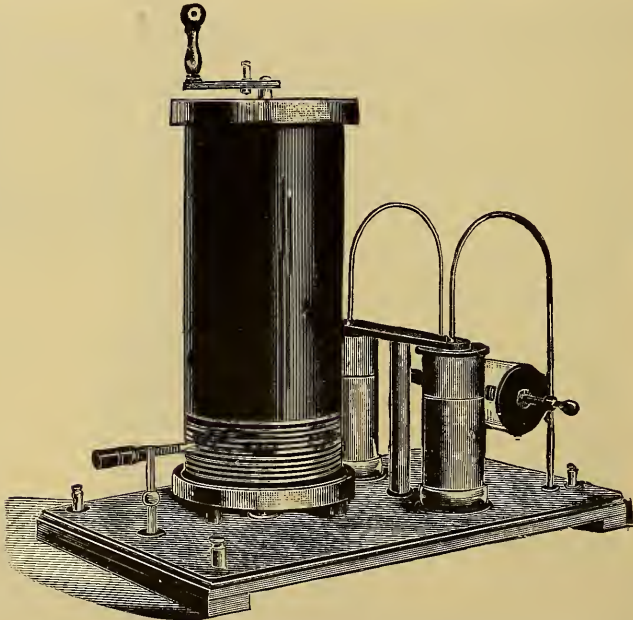

FIG. 56.—Resonator and Condensers (small model). (Williams.)

led to its being placed upon the market. The first few machines were made from the writer's designs, and under his personal supervision, by *Mr. E. L. Ovington* of the Massachusetts Institute of Technology.

The apparatus was subsequently manufactured by *Mr. Ovington* who devised several valuable improvements which increased its efficiency and lessened its liability to breakdown. It was at this time known as the "*Strong-Ovington Static Induction and High-frequency Apparatus.*" (See Fig. 57.) The only High-frequency Apparatus on the market at the time the

author's machine made its appearance, was the "*Knott Coil*," mentioned in a previous chapter (see Fig. 58). This apparatus, however, was used solely for X-Ray purposes, the therapeutic possibilities of the *Tesla* currents and the technic for their application being unknown to the profession until after the appearance of the writer's apparatus.

The "*Knott Apparatus*," in common with all other High-frequency Coils made prior to 1899, was assembled in oil; and the impossibility of preventing the latter from oozing through the joints of the heavy oak box in which it was contained, was

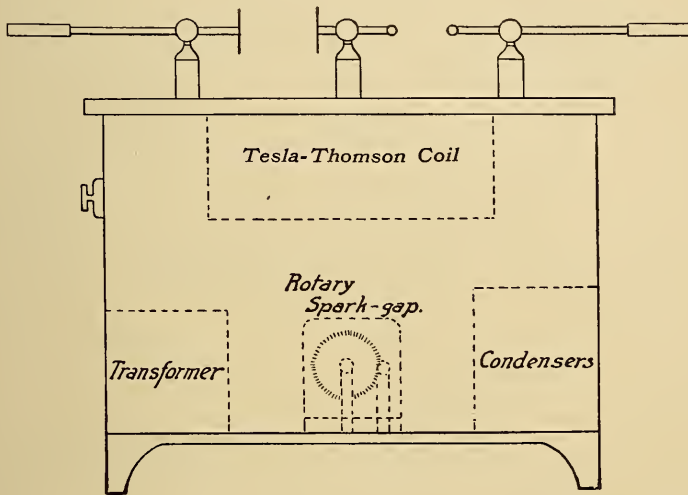

FIG. 57.—Diagram of the Author's Original Type of High-frequency Apparatus; "The Strong-Ovington Coil."

one of the chief disadvantages of the apparatus. Both *Tesla* and *Thomson* had stated that a liquid insulating medium was absolutely essential for High-frequency Apparatus, and that any solid substance, such as wax, or rubber, would sooner or later break down and allow the currents to pass.

The great power and volume of *Tesla* High-frequency Currents and the simple character of the generating apparatus, attracted the attention of certain European investigators shortly after the early clinical results of *d'Arsonval* and *Oudin* were published. Clinical tests were therefore made of currents generated on the *Tesla-Thomson* principle, but their obviously great therapeutic

power was offset by several serious and apparently insurmountable defects. The attitude of the European profession toward the *Tesla* currents is well expressed in the following quotation from an article which appeared several years ago in a prominent English journal:

“High-frequency Therapeutics as practised in Europe, is unknown in America, except for a few isolated attempts to apply *Tesla* currents for the relief of disease. These currents were thoroughly tested several years ago by European investigators, who found them to be absolutely impractical for therapeutic

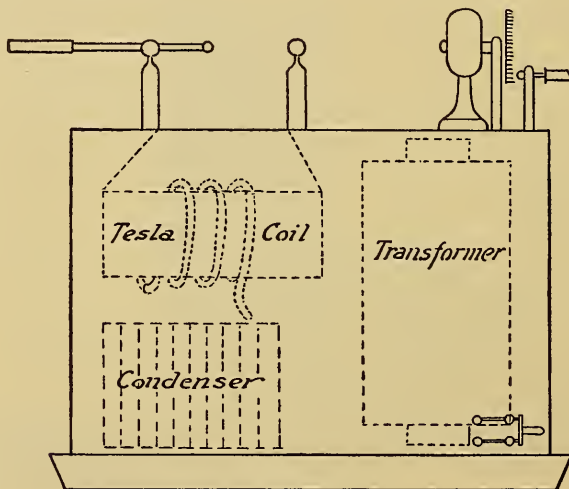

FIG. 58.—“The Knott” High-frequency Coil, Working Part Immersed in Oil.

purposes. The chief objection to the use of *Tesla* apparatus in therapeutics are:

“First—The great expense and cumbrousness of the apparatus, the parts of which must be permanently immersed in a bath of oil.

“Second—The great volume and power of the currents and the impossibility of properly regulating or controlling them.

“Third—The great danger attending the use of closed-circuit transformers in connection with alternating currents.

“The last objection is by far the most serious, the investigators having narrowly escaped a fatal shock while experimenting with currents derived from a *Tesla* apparatus.”

The above quotation has been widely circulated during the last few years by manufacturers of High-frequency Apparatus of the *Oudin-d'Arsonval* type, in the attempt to prejudice the profession against *Tesla* apparatus for therapeutic purposes. It will be noticed that the above objections do not apply to the currents, but to the apparatus which is employed in producing them. For a number of reasons, which will be discussed in a future chapter, the therapeutic action of currents of the *Tesla* type is superior to, and more efficient than that of the *d'Arsonval*

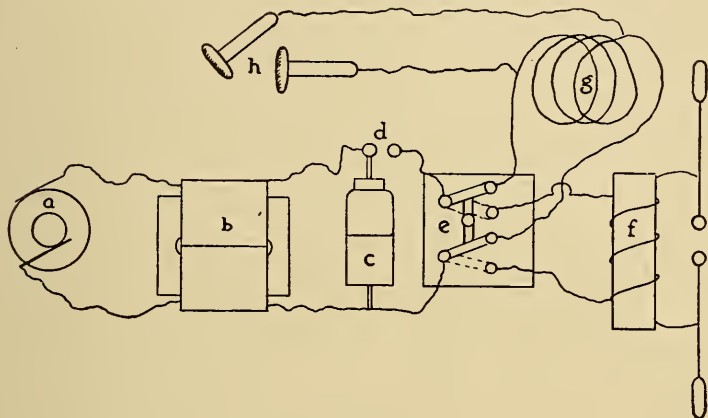

FIG. 59.—Diagram of the Author's Apparatus, Adapted for the Generation of heavy D'Arsonval Currents, as well as those of the High-potential ("Tesla") type.

a, Alternating Generator. *b*, Step-up Transformer. *c*, Condenser. *d*, Spark-gap. *e*, Switch for Discharging the Condenser through the D'Arsonval Solenoid (*g*); or the Tesla Coil (*f*). *h*, Sponge-covered Electrodes.

Current or of the Resonator Discharge. The writer demonstrated this fact, at least to his own satisfaction, in 1901, at which time he made a comparative study of the American and European types of High-frequency Currents. *D'Arsonval* Currents of even greater amperage than those obtained from a solenoid and *Ruhmkorff* Coil, were readily obtainable from the writer's early form of High-frequency Machine by the simple addition of two binding posts, connected to the extremities of the *primary coil* of the "*High-frequency*," or "*Tesla Transformer*." (See Fig. 59.) The writer discarded oil as an insulator during the first year of his investigations. By a suitable method of construction he

arranged the primary and secondary coils of his "*Tesla Transformer*," so as to isolate the points of highest potential, thereby lessening the tendency of the High-frequency Current to jump from the secondary to the primary coil. In this way he made possible the use of wax or paraffin instead of oil. This not only removed the objectionable features of the latter, but greatly increased the strength and durability of the apparatus, it being almost impossible to injure a *Tesla Coil* by any mechanical means, after the solidification of the wax in which it is imbedded. The same insulating medium was employed by the writer in the construction of his *condensers*, and although he has from first to last, built up his condensers with glass plates, coated with tin-foil, he has had but very little trouble from short circuiting or breaking down of the Dielectric. The substitution of wax for oil not only greatly simplified the apparatus but appreciably diminished the *expense* of its construction.

Scarcely a week passes that the writer's attention is not called either verbally or by letter to the "*great danger*" attending the use of *Tesla High-frequency Apparatus*. "Aren't you afraid of getting killed?" and "Isn't it very dangerous to use a 'closed-circuit transformer,' such as the one employed in your apparatus?" In reply to these and similar queries the following answers are usually given: "I have experimented with closed-circuit transformers, such as are used in my High-frequency Apparatus, for nearly ten years, during which time hundreds of shocks have been accidentally received both by my assistants and myself, yet in no case has there been any injurious or dangerous result, the reason for this being the *peculiar construction* of my step-up transformer and the relatively *low potential* of the *secondary currents obtained from them*."

In an ensuing chapter the effect of the degree to which the voltage is raised in the step-up transformer, on the resulting High-frequency Current, will be exemplified by comparing a series of coils, of different design, in which the potential obtained from the initial transformation ranges from 1,000 to 60,000 volts. For the present, it is sufficient to state that as a result of years of experiment, the writer has found that an alternating current of from five to twelve thousand volts is the most efficient for

charging the condensers of a therapeutic *Tesla* apparatus. The transformer from which this current is obtained is not only protected by a graduated inductive resistance coil, but is so constructed as to automatically limit the amount of current which it draws from the incandescent lighting mains. When the European investigators construct apparatus on the *Tesla* principle, they are apparently influenced by their knowledge of *d'Arsonval's* methods, which involve the use of *Ruhmkorff* Coil currents of from 50,000 to 100,000 volts. It is probably this fact that has led them to employ the 60,000 volt transformer in the new X-Ray and High-frequency Apparatus recently introduced by *Messrs. GaiFFE* for use on alternating incandescent light circuits (See Figs. 47-54). It is obvious that an alternating current of low frequency, and such a relatively high voltage, would produce dangerous and probably fatal results if accidentally passed through the human body. It will be seen from the preceding paragraphs, that the objections to the use of *Tesla* coils, cited by certain European authorities, do not apply to the apparatus employed by the writer in the elaboration of his "American System of High-frequency Therapeutics."

CHAPTER VII

THE DEVELOPMENT OF AMERICAN HIGH-FREQUENCY THERAPEUTICS

Earlier Forms of Alternating Current Apparatus

As has been stated, the first High-frequency Coils manufactured in America were of the *Tesla-Thomson* type. The "*Knott* Coil," which has been already described, was placed upon the market in 1897, and was used almost exclusively for the production of X-Rays. The "*Strong-Ovington* Apparatus," which

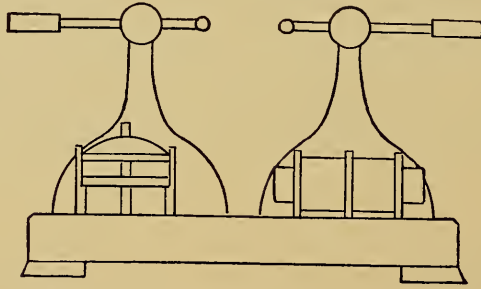

FIG. 60.—Kinraide Coil; Alternating Type.

was the American pioneer in *Therapeutic* High-frequency Coils, made its appearance in 1902, although the machine from which it was designed had been in constant use in the writer's practice since 1896. In 1901 the "*Kinraide* X-Ray Coil" was placed upon the market, and on account of its simplicity and relatively low cost met with an extensive sale. The publication of the writer's clinical results created a wave of interest in High-frequency Therapeutics, and led the manufacturers of the *Kinraide* Coil to exploit it for therapeutic purposes. (Fig. 60.) Many physicians possessing instruments of this type began to employ them in their practice in accordance with the technic described by the writer in several short articles which were published in the

medical journals of that period. The results were as a rule disappointing, and led in some cases to questions as to the reliability of the writer's statements regarding the therapeutic value of High-frequency Currents. In order to understand the reason for the disparity between the results obtained by the users of *Kinraide* Coils, and those produced by the writer's currents, the details of construction and the peculiarities of action of *Mr. Kinraide's* ingenious invention, may be briefly considered. His coils are of two types, designed respectively for the *Direct*, and for the *Alternating Current*. In the latter type, an Alternating

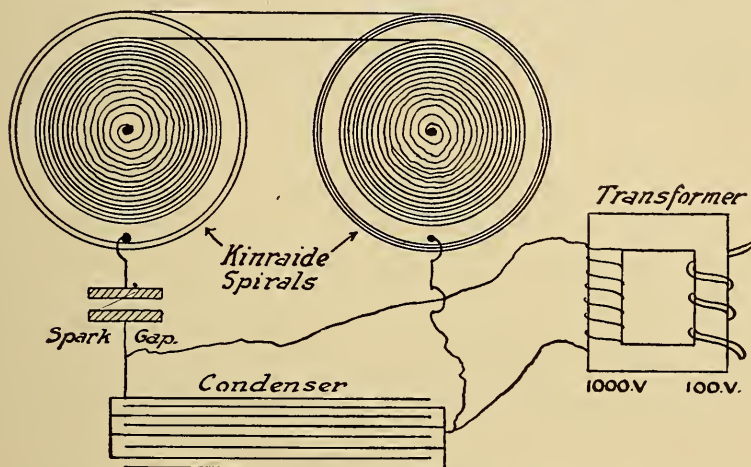

FIG. 61.—Diagram of Kinraide Coil Showing Relation of Spirals.

Current of 104 volts—(its frequency being generally 60 cycles per second)—passes through a small closed circuit transformer which "steps it up" to a pressure of about 1,000 volts; the latter circuit is then employed to charge a condenser, consisting of a large number of sheets of tin foil separated by thin sheets of flexible or "built up" mica. This condenser discharges disruptively across a short spark-gap between heavy copper plates, in series with the primary circuits of two High-frequency Coils, the latter being the unique features of the *Kinraide* apparatus. (Fig. 61.)

Each primary High-frequency Coil consists of six turns of thin copper ribbon wound one upon the other like the outer layers

of a roll of tape; a strip of varnished paper serves as insulation. Each primary coil when completed forms a *ring* or *hoop*, about eight inches in diameter and one inch in width, which fits tightly over a hard-rubber cylinder containing the secondary coil, the latter being concentric with, and in the same plane as the primary coil. The secondary coil consists of a moderately fine wire wound in the form of a concentric flat spiral, and insulated with the greatest care. This ingenious construction renders a breakdown practically impossible inasmuch as the point of the highest potential is at the center of the spiral, while the outer turns are rendered practically neutral by the use of two High-frequency Coils, connected in series and wound oppositely or symmetrically, the outer ends of both the primaries and secondaries

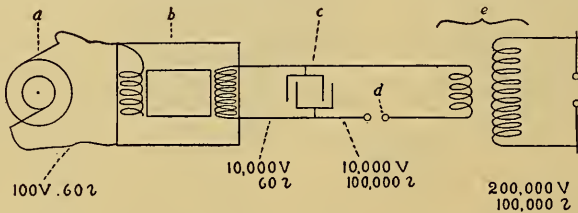

FIG. 62.—Tesla-Thomson High-frequency Apparatus.

a, Alternating Current Generator. *b*, "Step-up" Transformer. *c*, Condenser. *d*, Spark-gap. *e*, Tesla-Thomson High-frequency Transformer.

being connected by a single wire; the device is still further safeguarded by connecting the middle point of the wire which bridges the primary and secondary coils, to a single binding post attached to a *ground connection*.

Every *Tesla-Thomson* High-frequency Apparatus theoretically consists of *three transforming devices arranged in an ascending series*. (Fig. 62.) The first is an ordinary "step-up" transformer, having a closed magnetic circuit or "core" of soft iron, differing only from the commercial transformer used on alternating incandescent light circuits, in that it *raises*, rather than *reduces*, the potential of the alternating current. It is sometimes called the "High-tension Transformer," and while increasing the *voltage*, produces no effect on the *frequency* of the current. The second essential factor in a *Tesla-Thomson* apparatus converts the *Low-frequency High-tension Current* into a *High-frequency*

Current; it is essentially a *frequency transformer*, and has no effect on the voltage, or potential of the current. It consists of a *condenser* and a discharging circuit containing a certain amount of *inductance* in series with a *spark-gap*; this *inductance* forms the *primary circuit* of the "*Tesla Coil*," in which for the second time, the *voltage* of the current is increased. This coil possesses no iron core, and raises the current to an extremely high potential; the ratio of the voltage of the *primary*, to that of the *secondary circuit*, depends on the *number of turns in the primary coil* as compared with the *number of turns in the secondary*. This law of transformation applies also to *Ruhmkorff Coils*, and to ordinary closed-circuit transformers, and may be used to calculate the approximate voltage and amperage of their different circuits: it is mathematically stated as follows:—

$$\text{and } \begin{array}{l} V P : V S :: T P : T S \\ A P : A S :: T S : T P \end{array}$$

in which P, and S, stand respectively for the *Primary*, and *Secondary Circuits*; T for the number of turns of wire; A, for the amperage, and V, for the voltage. It is evident from the above equation that the *voltage* in the coils of a transformer varies *directly*, while the *amperage* varies *inversely*, with the number of turns of wire. The *frequency* of the current from a *Tesla coil*, is an *inverse function* of the *capacity of the condenser*; the greater the capacity, the lower the frequency, and vice-versa.

In consideration of this fact it will be evident that the frequency of the *Kinraide coil* is extremely low,—too low, in fact, to produce the characteristic physiological effects to which the High-frequency Current owes its great value as a therapeutic agent.

In the early years of the writer's investigations he made a series of comparative tests in order to determine the relative therapeutic values of High-frequency Currents of different rates of oscillation. A variety of apparatus was employed, the *lowest frequencies* being derived from the *Kinraide Coil* and the *highest*, from a small *Tesla Coil*, excited by a current from a pair of medium-sized *Leyden Jars* connected to the terminals of a ten-

plate *Waite & Bartlett* Static Machine. The currents from the apparatus just described, while necessarily of extremely small amperage, were of extremely high voltage and frequency; characteristics which rendered them of especial value in the treatment of diseases of a *superficial* and *circumscribed* nature. The writer's practice at this time was confined almost exclusively to the treatment of diseases of a nervous and rheumatic character, and the "Static High-frequency Apparatus" was seldom used after the completion of the series of comparative tests above

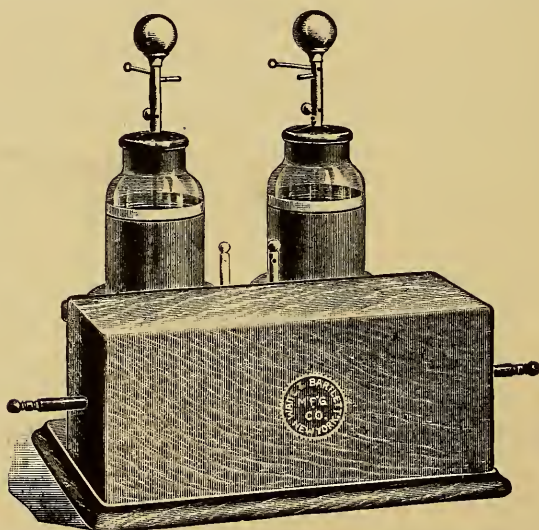

FIG. 63.—Piffard's Hyperstatic Transformer.

described. A year or two later a perfected form of Static High-frequency Apparatus was devised by *Dr. H. G. Piffard*, of New York City. This device which is known as the "*Piffard* Hyperstatic Transformer," has given excellent results, and is widely employed by users of the static machine. (Fig. 63.) *Piffard* has achieved remarkable results with his little apparatus, especially in dermatological work; he has recently improved and modified its construction so as to adapt it for use in connection with a *Ruhmkorff* Coil. It forms an integral part of an American High-frequency and X-Ray Apparatus which has recently been placed upon the market and which will be described in an ensuing chapter.

It is obvious that oscillating currents of different frequencies affect the functions of the body in different degrees—an assumption which is confirmed by clinical experiences—the “Hyperstatic Currents,”—which are higher than the majority of *Therapeutic High-frequency Currents*,—while valuable in the treatment of skin diseases, are less efficient in the treatment of constitutional ailments involving depleted nervous energy and poor circulation, while the currents from the writer’s apparatus are especially adapted to the treatment of the latter conditions.

Diseases involving the muscles and motor nerves are most efficiently treated by currents of a *very low-frequency*—that is, *Low* from a *High-frequency standpoint*; in other words, too low to allow of their practical generation by the disruptive discharge of a condenser. A Faradic coil provided with a *ribbon rheotome* or a small *sinusoidal alternator*, giving a current of a maximum frequency of 5,000 per second being best adapted for the purpose.¹

The *Kinraide* Coil charges its condenser with a current of *high-amperage* and relatively *low voltage*—the extremely high-potential of the High-frequency Current from this coil, resulting almost solely from the “*step-up*” transformation in the *Tesla* Coil. In most High-frequency Apparatus the increase of the potential is more or less equally divided between the “High-tension Transformer” and the “High-frequency,” or *Tesla* Transformer. In *Gaijfe’s* new X-Ray and High-frequency Apparatus, described in a preceding chapter, the alternating incandescent light current is raised from 104 volts to 60,000 volts, before being conducted to the condensers. *Piffard’s* Hyperstatic, when used with a large *Holtz* machine charges its condenser at an even *higher voltage*.

The various machines designed and employed by the writer occupy a position between the two extremes respectively exem-

¹ No absolute rule exists for the use of the terms “High” and “Low” Frequency: “Frequency” is a purely relative term. In the present volume the writer has, for the sake of convenience, defined a *High-frequency Current* as an alternating current which does not produce muscular contractions or affect the sensory nerves; it has, in other words, a frequency of over 10,000 per second; it happens that this frequency, which marks the limit of sensation and motor re-action is the highest frequency obtainable by mechanical alternators, and we may therefore regard the term “*High-frequency Current*” as synonymous with “*Oscillatory condenser discharge*.”

A full discussion of the relation between *frequency* and *therapeutic effect* is given in the second chapter on “Physiology.”

plified by the *Piffard* and *Kinraide* Coils. The capacity of the writer's condensers averages from twenty to thirty times that of *Doctor Piffard's* Hyperstatic Transformer, but it is only one-fiftieth of the capacity used in the *Kinraide* Coil. The writer's



FIG. 64.—Brown High-frequency Coil.

machines, therefore, generate currents of a much lower frequency than those produced by the former, but of vastly greater frequency than that of the *Kinraide* Current.

The peculiar principle involved in the *Kinraide* Coil has been employed in the construction of two portable forms of High-

frequency Apparatus, which, although of different make, are so near alike in mode of action, and detail of design, that they may be appropriately described under a single heading. A fair idea of their general appearance and arrangement of parts may be

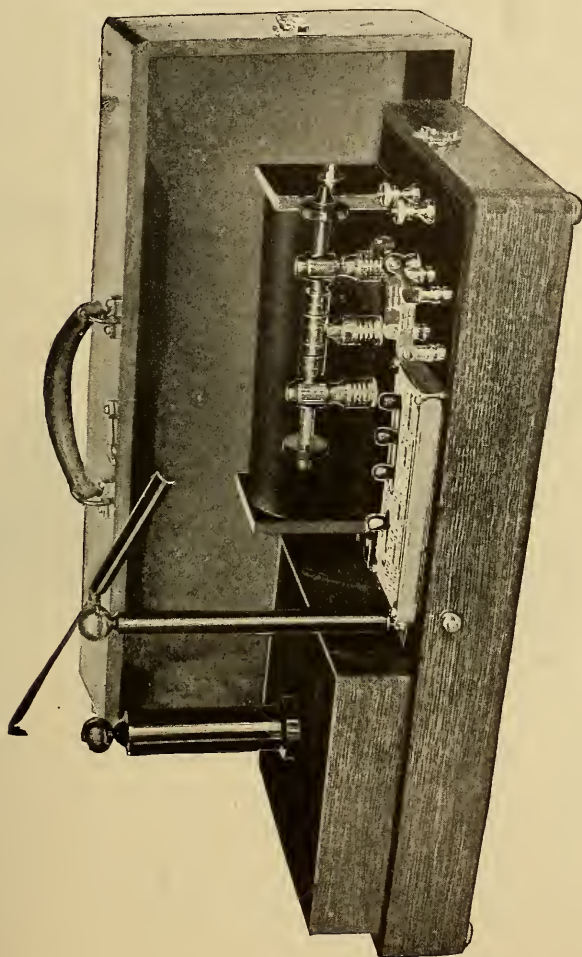

FIG. 65.—Campbell High-frequency Coil.

obtained from the illustrations in Figures 64 and 65. Each of these coils is designed for operation on the 104-volt alternating current, and consists essentially of a small closed-circuit transformer similar to that used in the *Kinraide* Coil, except that the ratio of transformation is somewhat greater, the secondary

current having a potential of 2000 volts. The condenser is very much smaller than that of the *Kinraide* Coil, and consequently produces currents of much higher frequency. A single High-frequency Transformer is used, instead of two, as in the *Kinraide* Coil; but the principles are the same in both instruments; the secondary consists of a single flat spiral, its center, or point of highest potential, terminating in an upright rod capped with a brass ball and insulated with a hard-rubber bushing. In the coil shown in Fig. 65 the spiral secondary just described is firmly

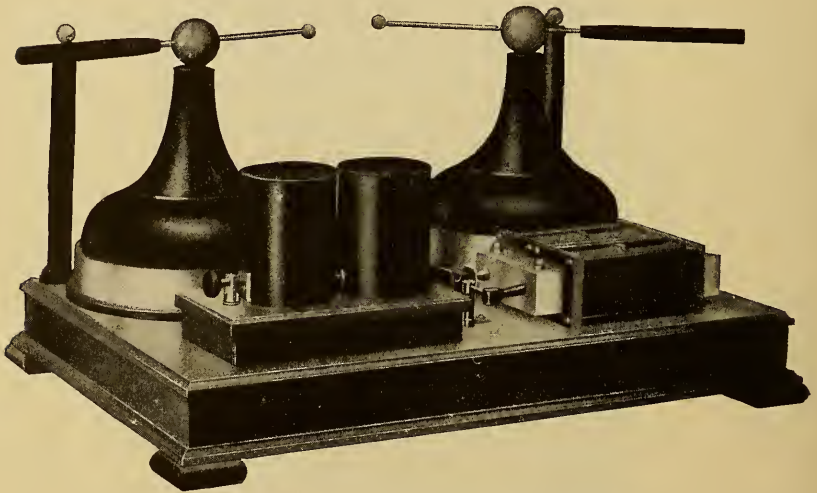

FIG. 66.—Kinraide Coil with Improved Spark-gap.

mounted on the same base with the transformer, spark-gap, and condenser, while in the second apparatus, it is arranged to fold inward at an angle of 90 degrees during transportation, the oscillating current from the condenser being conducted to the primary spiral by means of the two metal hinges. The objectionable feature of all apparatus of the *Tesla-Thomson* type has been the *spark-gap*, the corrosion and heating of its terminals seriously impairing the smoothness of the High-frequency Discharge and lowering the efficiency of the coil. In the original form of the *Kinraide* Coil this defect was of such a grave nature that many operators disposed of their apparatus at a considerable sacrifice, regarding it as totally impractical and unreliable.

This objectionable feature has been entirely eliminated in the *Kinraide* Coil shown in Fig. 66, which is provided with an improved spark-gap consisting of two brass tubes closed by platinum caps, between the outer faces of which the discharge occurs; the brass tubes project from adjacent points in two cylindrical brass vessels filled with water, which conducts away the superfluous heat of the spark-gap and renders the High-frequency Discharge from the secondaries full, continuous and steady. With the addition of this new spark-gap the *Kinraide* Coil has become a convenient and reliable apparatus for the generation of the X-Ray on alternating circuits, and for use in wireless telegraphy. It is probably the most *efficient* High-frequency Transformer yet devised, as the power and volume of the secondary discharge is truly enormous as compared with the extremely small amount of electrical energy which the coil draws from the mains; its relatively low frequency, however, renders this apparatus unsuitable for therapeutic purposes, while the two coils above described which have condensers of much smaller capacity produce currents which may be successfully employed in the treatment of disease. This reduction in condenser capacity, however, is made at the expense of efficiency, and for heavy X-Ray work a dangerously high amperage must be employed. For the general run of X-Ray and High-frequency work, however, these coils are said to give very satisfactory results.

Several years ago the manufacturers of the *Kinraide* Coil, recognizing its inefficiency as a Therapeutic High-frequency Apparatus, introduced an instrument of similar construction but producing currents of much higher frequency, called the "*Cyclone Coil*." (See Fig. 67.) This apparatus, which is no longer manufactured, is mentioned as an important example in the comparative study of High-frequency Coils; it uses a step-up transformer which raises the potential of the 104-volt alternating current to between five and ten thousand volts. Glass condensers are used instead of mica, and the two secondary coils (which are of the *Kinraide* type) produce a High-frequency Current sufficiently powerful for ordinary X-Ray work. Although these coils have been used with some success in therapeutic work, they do not conform with the requirements which

have been formulated by the writer as essential in a High-frequency Apparatus for physicians' use. This list of requisite characteristics embodies the writer's deductions from ten years' practical experience in the construction and therapeutic use of High-frequency Coils.

In the first place, the apparatus must be convenient and attractive in external appearance and capable of transportation

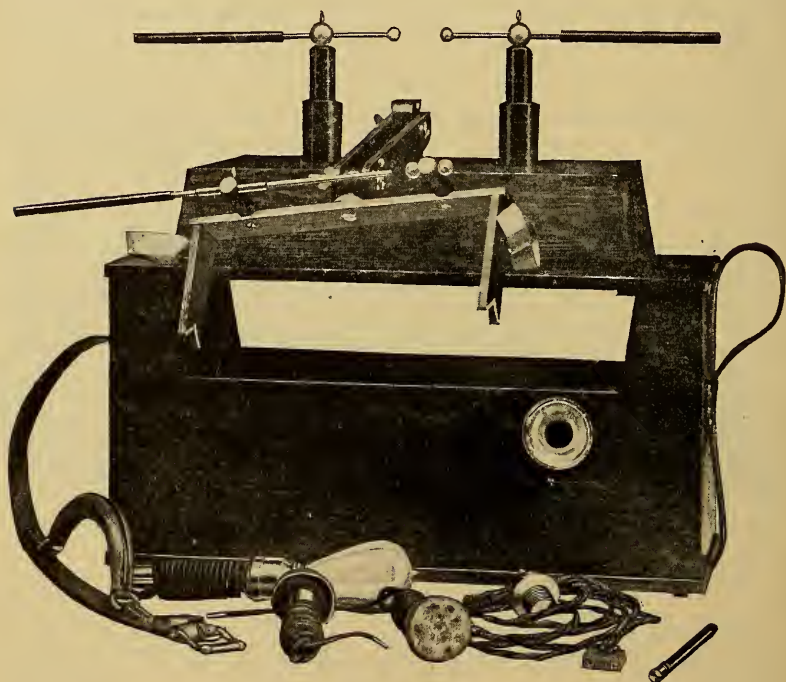

FIG. 67.—Cyclone Coil. (Portable form.)

without fear of injury to its working parts, or loosening of the wires connecting its various circuits.

Second, its transformers and condensers should be strongly made of the best obtainable material, and so perfectly insulated as to render the possibility of a breakdown exceedingly rare; but in the event of such an accident, the working parts should be easily and freely accessible, so as to enable the *physician himself*, in the absence of an electrical expert, to test out his own apparatus, locate the point at which the breakdown or interruption

of the circuit occurred, and, if necessary, remove the injured part for repairs.

Third, the current should be under perfect control, and the output in the secondary should be capable of regulation by the following methods: (a) the graduation of the current used to excite the primary coil of the step-up transformer by means of a *Rheostat*, or an *adjustable inductive resistance*; ("Choke Coil"). (b) By a variable *spark-gap*, provided with an easily accessible micrometer adjustment. The spark-gap should be self-cooling, and if at all noisy, should be completely enclosed in an asbestos-lined compartment. Its discharging surfaces should be easily removable for cleaning, and if the action of the spark causes them to corrode and wear away they should be so constructed as to be easily and economically replaced. It should be possible to run the apparatus at its maximum output for several hours continuously without overheating, and without evidence of fluctuation or loss of efficiency. (c) There should be some method of varying the potential of the discharge by the introduction or withdrawal of resistance in the external circuit; this may be accomplished by the use of a variable air-gap between brass disks attached to the ends of sliding rods, by interposing glass plates, vacuum tubes, or insulated inductance coils in series with the patient in the external circuit.

Fourth, the various parts of the apparatus should be so proportioned that the High-frequency, High-potential Current from the *Tesla* Coil will possess the following characteristics: (a) Sufficient voltage or potential for the production of a full fine-grained "*Effluve*," at a distance of eight inches or more from the patient; the character of the discharge being such as to admit of this distance being reduced to three or four inches without danger of "arcing" the patient. In applying the *brush* discharge from the static machine, care must be taken to prevent the electrode from approaching too near to the patient's body, otherwise a *bright spark* will jump to the latter, causing a painful and unpleasant shock, with sharp muscular contractions. With *Tesla* Currents a somewhat different phenomenon occurs, the *effluve* being changed, not to a *spark*, but to an *arc discharge*, or an actual electrical flame, which often burns a small hole

through the clothing and causes a painful "sear" or blister, before the electrode can be withdrawn to a safe distance. By cutting out the secondary oscillations, by the interposition of *ohmic resistance* in the condenser circuit ("damping" the oscillation in other words), we can obtain from a *Tesla* Coil "Brush" and "Spark" Discharges closely resembling those produced by a static machine.¹ (b) The currents should have a relatively high frequency with the *shortest possible intervals* between the *different sets of oscillations*, so that no sensation of shock or fluctuation will be felt when the patient is placed directly across the *Tesla* Circuit, or when the current passes through the patient's body in series with an incandescent lamp. (c) The current should have a relatively high amperage, capable of bringing to full brilliancy an eight candle power incandescent lamp, when the latter is connected between the hands of two persons, one of whom holds in his free hand a terminal of the *Tesla* Coil. The current from a single terminal should be capable of brilliantly illuminating a series of five or more *Geissler* Tubes when the latter form connecting links between the hands of an equal number of persons. In order to obtain the best therapeutic results, it is necessary that a current be employed which will manifest its potential, frequency, and amperage, by lighting lamps or vacuum tubes in the *above manner*, as efficiently as when the bulbs or tubes *form a direct connection* between the body and the *Tesla* terminal. There are many coils on the market which will excite a "vacuum electrode," connected to one of their poles, so strongly that the surface of the patient's body will be blistered by a few seconds of contact with the electrode; while, if the patient be connected to the same pole by a metal handle, the above vacuum electrode will be scarcely illuminated if held in the hand of the operator and brought in contact with some part of the patient's body. The currents from such machines are useful only for the treatment of local and superficial lesions. With the best machines a *Geissler* Tube held in the hand of the operator, will glow when brought within a radius of four or five feet from a patient connected to one of the terminals of the *Tesla* Coil. (d) The *Tesla* Currents

¹ See "Pseudo-Static Effects," in chapter on "High-frequency Modalities."

should be of sufficient volume to produce X-Rays capable of giving a clear fluoroscopic picture of the thorax, shoulder-joint, etc., and of giving a satisfactory skiagraphic negative of the bones of the hand in one second or less, when the machine is drawing not more than 500 watts from the mains.

The exact details of construction necessary for the production of an apparatus having the above ideal characteristics can be determined by experiment only, and the writer's efforts in this direction were but partially successful until about two years ago, when he was fortunate enough to discover a combination producing results of the above character. The fortuitous circumstances which led to these results, while in some degree accidental, were mainly brought about through an exhaustive comparative study of the various types of High-frequency Apparatus that had been produced up to that time, including the writer's earlier models. For a long time it seemed to be impossible to produce currents which should be equally satisfactory for therapeutic use and X-Ray purposes. The *Kinraide* Coil produced X-Rays of great power and penetration, but has been shown to be impractical for therapeutic use: the writer's earlier apparatus, on the other hand, while seemingly ideal as a generator of *Therapeutic* High-frequency Currents was decidedly inferior to the *Kinraide* Coil for X-Ray work. The successful production of one of these requirements seemed possible only by sacrificing the second end in view: indeed, the two seemed incompatible. There is reason to believe that other investigators reached the same conclusion. For example, the "*Jackson* Coil," invented jointly by *Mr. Kinraide* and *Mr. Howard Jackson*, which was an ideal instrument for High-frequency Therapeutics was frankly avowed by its manufacturers to be unsatisfactory as a generator of X-Rays, for other than therapeutic purposes. This coil, which is no longer manufactured, embodied a number of new and unique features which are worthy of a brief description. The High-frequency Transformers are of the "*Kinraide* type," but the secondary spirals contain fewer turns of wire, and the ratio of voltage between the primary and secondary circuits is much smaller than in the *Kinraide* Coil. In the latter the high potential is obtained

almost entirely through the transforming action of the High-frequency Coils, while in the *Jackson Apparatus* the voltage is raised for the most part by the "step-up" transformer in the Low-frequency Circuit: the *Jackson Condenser* has but small

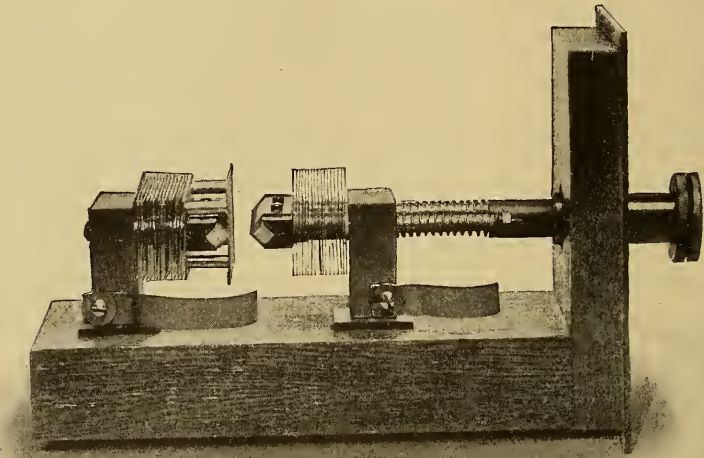

FIG. 68.—Spark-gap of Jackson Coil.

fraction of the capacity of that of the *Kinraide Coil*, and consequently discharges at a much higher frequency; as the charging circuit has a potential of from 30,000 to 40,000 volts, the amperage at the spark-gap is much less than in the *Kinraide Coil*; consequently much less heat is evolved and water cooling devices are unnecessary. The spark occurs between the edges

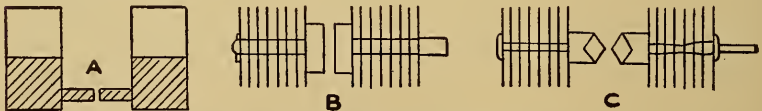

FIG. 69.—High-frequency Spark-gaps.

A, *Kinraide Coil* (improved). B, *Cyclone Coil*. C, *Jackson Coil*.

of two horizontal bars of iron about two inches long, square in section, and about one-half inch in diameter; the gap between them may be varied by a micrometer screw and the jaws which support the bars are each provided with a series of thin copper

plates to radiate the heat; if the edges of the bars become blunted or corroded, the latter may be withdrawn, and turned through an angle of 90 degrees, so as to bring a fresh edge into position. (Fig. 68.) This spark-gap gives excellent results in the *Jackson* Coil but it is not satisfactory when employed in a condenser circuit of low voltage, such as is used in the "Cyclone Coil" for example. (See Fig. 69.) In the latter instrument the spark takes places between the parallel faces of iron disks about three-quarter inches in diameter; these are mounted with radiating

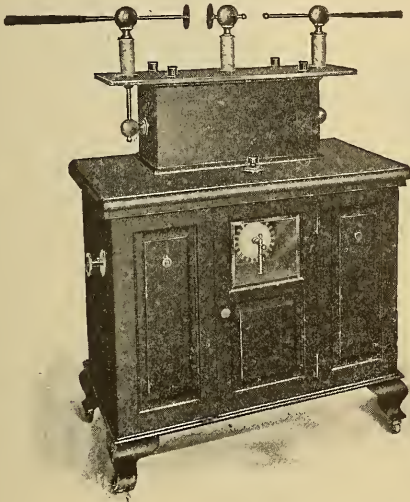

FIG. 70.—The Author's "Special Hercules" Coil.

wings, as in the *Jackson* Gap. The general appearance and construction of the spark-gaps of the *Kinraide* Coil, *Cyclone* Coil and *Jackson* Coil are shown in the illustration (Fig. 69). The High-frequency Transformers of the *Jackson* Coil are entirely separate from the rest of the apparatus and are supported by an upright wooden mast which is either fixed to the back of the cabinet, or mounted independently in an iron tripod as in Fig. 71, and the primaries of the High-frequency Coils are so arranged as to allow of one or both secondaries being used, so that the effects of a *Tesla* Coil or an *Oudin* Resonator may be obtained as desired. The greatest value of the *Jackson*

Coil lies in its beautiful "*Effluve*," which is full, of fine grain and free from fluctuation; while it may be controlled or gradu-

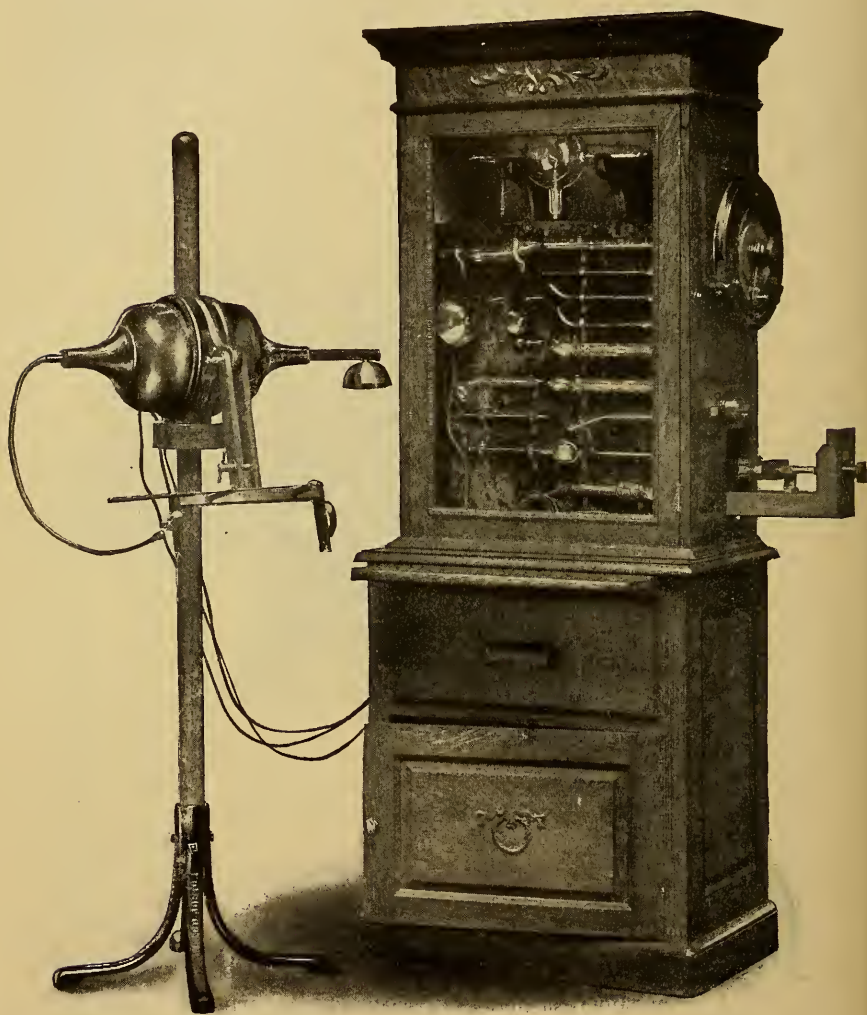

FIG. 71.—Jackson Coil with Separate Secondaries.

ated with the greatest nicety by the micrometer spark-gap, and by an adjustable *Rheostat* in the Low-frequency Circuit. Heavy "*d'Arsonval* effects" are obtained from the *Jackson* Coil by

diverting the condenser discharge from the *Tesla* Circuits to a heavy spiral solenoid called the "Thermo-Faradic Coil," which will produce as high as 3,000 milliamperes of current.

In the ensuing chapter the writer will describe his latest High-frequency Coils, which conform to the list of requirements enumerated in the preceding pages.

CHAPTER VIII

MODERN HIGH-FREQUENCY APPARATUS OF THE AMERICAN TYPE

Tesla-Thomson Coils

THE machines which the writer employs in his practice at the present time embody the most recent deductions from his clinical and experimental researches. They are of three different models, being denominated by their manufacturers as the "Hercules," the "Ajax," and the "Hercules Universal"; the first two are of the "*Tesla* type" for use on *alternating electric light currents*; the third or last being a *direct* or *continuous current machine*, although arranged to work equally well on an alternating supply. The term "*Universal*" is employed not only from the adaptability of the apparatus as regards exciting currents, but from the fact that it combines in a single instrument a *Ruhmkorff Coil*, *Resonator*, and *Tesla Coil*. The details of the "Hercules Universal" will be discussed under a future heading.

Of the two alternating machines, the "Ajax" Coil is probably the more important from the standpoint of the general profession. The "Hercules Apparatus" is of a very elaborate and expensive construction and is designed primarily for the *electro-therapeutic specialist*. The "Ajax" Coil of the conventional type is shown in Fig. 72. Fig. 73 shows a larger and more pretentious type known as the "Ajax special." These two machines are identical in so far as their transformers, condensers, spark-gaps and *Tesla* Coils are concerned, but the "Special" model involves a convenience of arrangement, easy accessibility, and range of usefulness, not found in its simpler prototype. It is provided with a heavy solenoid producing powerful "*d'Arsonval*" and "Thermo-Faradic currents," has a stepped inductance for the graduation of its primary current, and may be equipped, if desired, with a separate transformer for the production of cautery and diagnostic light currents.

The development of the "Ajax" Special, and the arrangement of its various details is the work of *Mr. John R. Parker* (Superintendent of Construction for the Electro-Radiation Company) to whom the writer is indebted for many new ideas and practical suggestions employed in the production of his latest types of apparatus.

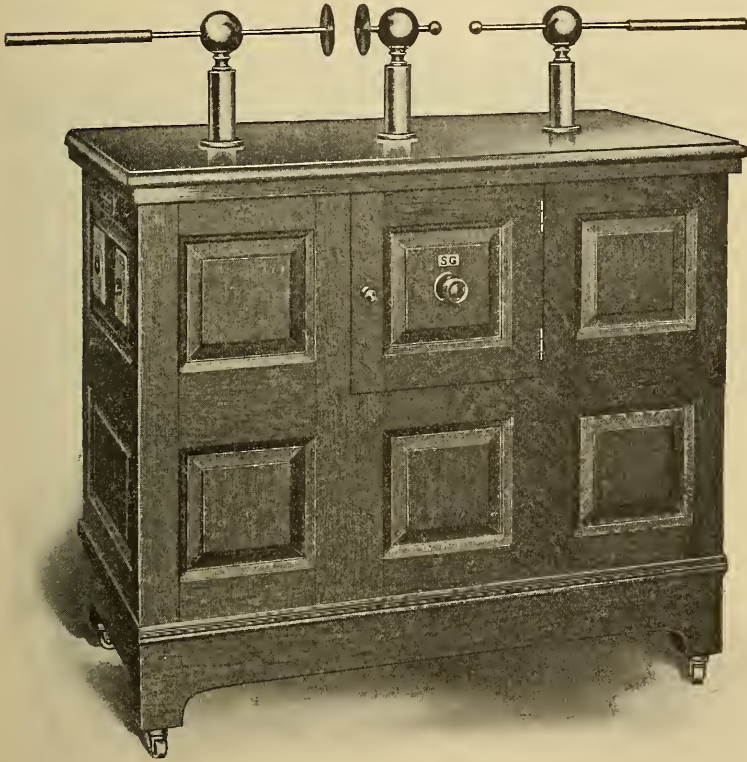

FIG. 72.—The Author's "Ajax Coil."

In the "Special Ajax" the 104 volt alternating current is passed through a conventional *closed-circuit transformer*, in which the potential is raised to about 10,000 volts. The amount of current delivered from the transformer is determined by the "stepped" inductance above-mentioned, which admits either one, two, or three and a half amperes to the primary coil; according to whether the plug on the end of the service cord is attached to

the first, second or third pair of pins (see Fig. 74). The capacity of the condenser is such that a frequency of about one million (1,000,000) per second is produced in the *Tesla* and *d'Arsonval*

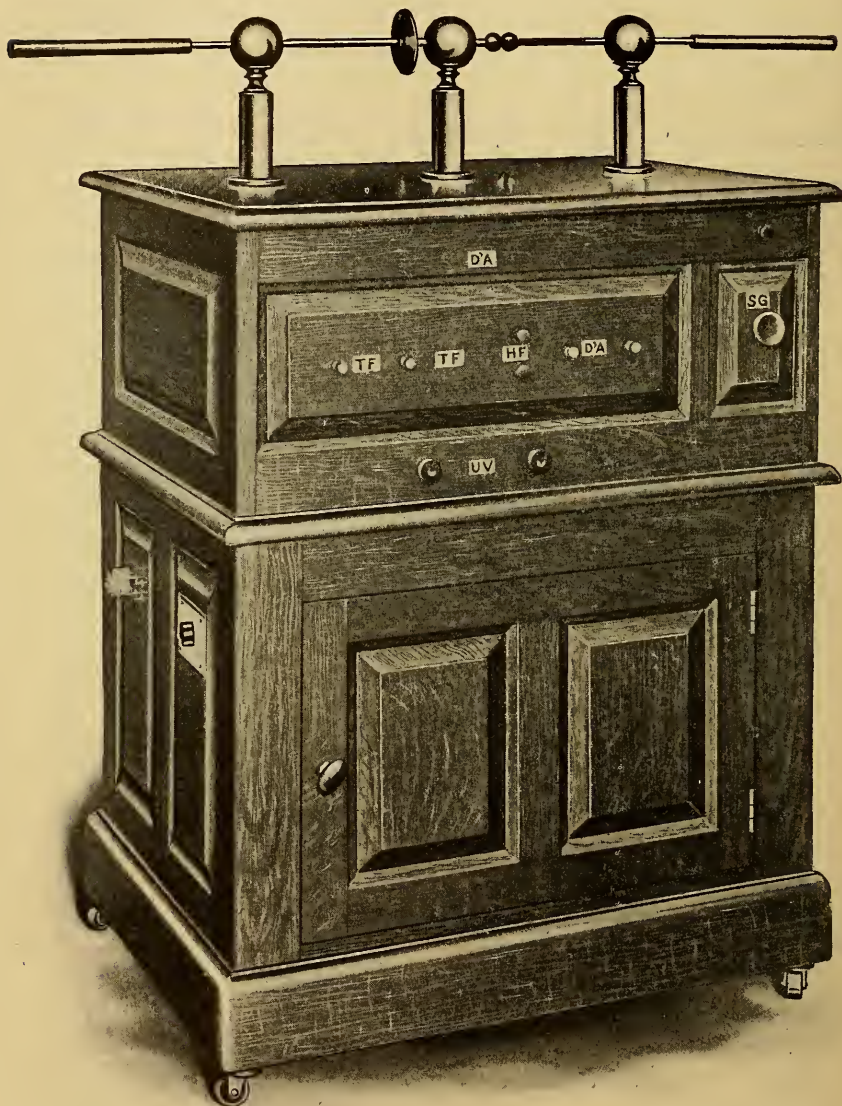

FIG. 73.—The "Ajax Special Coil."

Circuits. The condenser consists of a number of sections, each of which contains five pairs of glass plates coated with tin-foil and firmly imbedded in a wax composition; this construction allows of the removal of a portion of the condenser in the rare event of one of the glass plates being shattered by rough handling of the machine during transportation, and, inasmuch as the machine will work satisfactorily on a condenser of less than its normal capacity, the damaged section may be shipped to the factory for repairs. The *spark-gap* is similar to that employed in the *Cyclone coil*, previously described (see Fig. 69), except that the iron disks of the latter are replaced by brass pieces faced with pure silver. The coil which the writer employs in his practice at the present time, is provided with a spark-gap similar in principle to the above, but of an improved construction, involving several new and important features; the movable

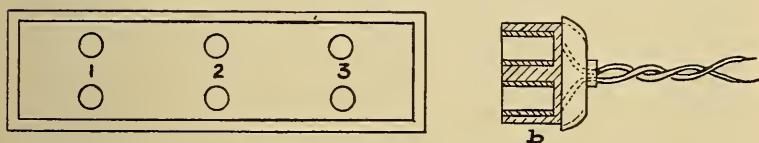

Fig. 74.—“Theater Plug,” for varying current strength on “Cyclone” and “Ajax Special Coils.”

member is operated by a *cam* or *eccentric*, which varies the spark-gap from zero (or contact), to a maximum length of five millimeters, corresponding to a rotation of the *cam-shaft* through an arc of 180 degrees. The hard-rubber adjusting knob is attached to the end of the *cam-shaft* which projects through the door of the cabinet, and is provided with a *metal hand*, or pointer, moving in front of a scale which indicates the length of the spark-gap in millimeters and tenths of a millimeter. By turning the knob to the extreme right, bringing the hand opposite the letters “U. V.” on the scale, a gap of five millimeters is formed, which is too great a distance for the current to traverse; consequently no spark passes, and the apparatus may then be used to operate an *ultra-violet lamp* which is connected to the condenser circuit by means of suitable terminals. (Fig. 75.)

The “High-frequency” or “*Tesla-Thomson*” Transformer employed in the “Ajax” machine, consists of a *primary* composed

of a small number of turns of coarse wire wound upon a tube about six inches in diameter, which is slipped over the center of the *secondary coil*, which is formed of a great many turns of *extremely fine* silk insulated wire, closely wound upon a tube four inches in diameter and about two feet in length. The annular space between the primary and secondary tubes contains a number of layers of flexible mica and the *High-frequency Transformer* thus assembled, is permanently embedded in solid wax in a suitable wooden box, the primary and secondary terminals being brought through the walls of the latter by rubber insulating bushings. The High-potential High-frequency Current is led from the "*Tesla*" secondary to a pair of insulated terminals surmounted by brass balls; a third terminal called

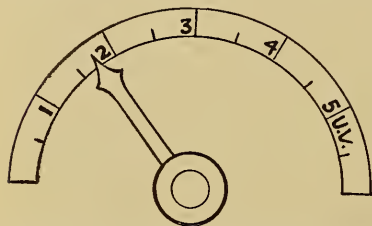

FIG. 75.—The Author's New Graduated Spark-gap, for Ajax Coils.

the "*dummy*" is fixed on an insulated pillar midway between the two active terminals, and consists of a brass disk cooperating with a similar disk on the end of a sliding rod in the left-hand terminal; a second sliding rod in the right-hand terminal ending in a

small brass ball, its counterpart being fixed to the right-hand side of the "*dummy*." When the machine is in operation, and the right-hand rod pushed into contact with the "*dummy*," a brilliant purple "*Effluve*" will be formed between the *brass disks*, when the latter are separated by a gap of three or four inches; if the disks be in contact, and an air gap formed on the *right-hand side* of the "*dummy*," between the two *brass balls*, the discharge will occur in the form of a *flaming "Arc,"* or pencil of light. The uses of these triple terminals to produce various modifications in the character of the secondary current will be considered in detail in a later chapter.

The "*Hercules*," shown in Fig. 76, closely resembles the "*Ajax*" in so far as its electrical construction is concerned, except that a rotary spark-gap is employed instead of a stationary one. The former, shown in Fig. 77, consists of a brass disk mounted on the end of the shaft of a small alternating

motor, being insulated from the latter by a heavy fiber bushing. The periphery of the disk is divided into rectangular teeth, one-half inch in width, by slots of the same width and depth; the thickness of the disk is about one-eighth inch. The current



Fig. 76.—The Author's "Hercules" High-frequency Apparatus.

from the condenser is admitted to the disk by means of a *graphite brush*, which presses against a *graphite button* held in a cup-shaped depression in the exact center of a rotating disk. The spark-gap is formed between the upper edge of the disk and a brass ball on the end of a vertical rod, which projects through

a threaded bushing in the top of the cabinet and terminates in a hard-rubber adjusting knob. The writer has recently improved his rotary gap by substituting for the threaded ball-tipped rod a *disk* of nickel or silver mounted eccentrically upon the lower end of a vertical rod, mounted not in the plane of the disk but about one inch in front of it. The spark, instead of following a vertical path between the upper edge of the revolving disk and the lowest point of the brass ball, traverses a *horizontal gap* between the outer surfaces of the revolving teeth and the inner edge of the silver disk; the latter is somewhat rounded on its edges, and is about three-fourths inch in diameter and one-fourth inch in thickness; it is attached to the rod by means of a

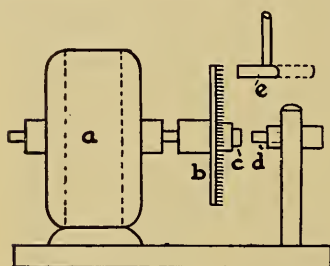

FIG. 77.—The Author's Improved Rotary Spark-gap.

a, Motor. *b*, Slotted Disk. *c*, Graphite Button. *d*, Graphite Brush. *e*, Silver Disk Mounted Eccentrically.

threaded hole midway between its center and periphery. The rod turns by means of a knob, as in the former model, but its bushing is not threaded, and brass collars fixed to the rod above and below the bushing prevent all motion of the silver disk except in a horizontal plane. A pointer attached to the brass rod just below the rubber knob, moves in front of a curved scale and indicates the length of the gap in the manner described in

connection with the "Ajax" machine. The rotary spark-gap just described does not appear to operate satisfactorily on all types of High-frequency Apparatus, but it is peculiarly adapted to the particular voltage, amperage and frequency of the condenser discharge in the "Hercules" machine. It appears to produce a peculiar effect on the High-frequency Current which renders the latter more efficient for certain therapeutic purposes. This action will be discussed more fully in an ensuing chapter.

The frequency of the "Hercules" machine is slightly less than that of the "Ajax," as the condenser capacity is greater than in the latter machine. The voltage of the *Tesla* current in the "Hercules" is distinctly higher than in the "Ajax" and the machine draws a larger amount of electricity from the mains.

The perfect manner in which the heat is dispersed by the Rotary Spark-gap makes it possible to operate the "Hercules" machine continuously for hours without danger, or loss of efficiency. The "Hercules" Low-frequency Transformer, while similar in action to that of the "Ajax" is of a more complicated and expensive construction. Aside from the points above enumerated, the "Hercules" coil differs from the "Ajax Special" solely in its more elaborate and expensive cabinet and mountings.

CHAPTER IX

MODERN AMERICAN HIGH-FREQUENCY APPARATUS, FOR "DIRECT CURRENT" USE

MANY physicians who prefer to employ the "*Tesla-Thomson*" type of High-frequency Apparatus have been handicapped by their inability to obtain an *alternating current service*. In the central portions of large cities and in occasional small ones, the *direct* or *continuous current* is the only source of supply. This is especially true in England and on the Continent. The first attempt to devise a means to adapt *Tesla* Apparatus to *direct currents* was made in connection with the original "*Knott High-frequency Coil*," and involved the use of a slate wheel bearing metal segments revolving against carbon brushes, and acting as a *commutator* which changed the *direct current* to an *interrupted alternating current*; but the slate wheel rapidly wore out, the brushes required frequent adjustment, and the device was extremely noisy and cumbersome. Despite these facts, the writer employed a break-wheel of this type for several years, all of his clinical work at the Boston Dispensary being carried out by means of such an apparatus. When the "*Strong-Ovington machine*" was placed upon the market, it became evident that some other means must be found for alternating the direct current, and, after some experiments, it was decided to adopt what is known as a "*rotary converter*." This apparatus (see Fig. 78) is a "shunt-wound" direct current motor, with the armature tapped at two diametrically opposite points connected respectively to two insulated "collector rings," which are usually mounted on the end of the armature shaft opposite to that which carries the commutator. Two carbon brushes bear against the revolving rings, and from these brushes a true *alternating current* may be obtained—the number of cycles per second corresponding to the number of revolutions of the arma-

ture during the same interval of time. The voltage of this alternating current is usually about four-fifths that of the original direct current and it is therefore necessary to employ a slightly higher ratio of transformation in the step-up transformer, in order that the condenser may be charged at the same potential as when the machine is operated on the ordinary alternating incandescent light current. In the larger types of rotary converters it is possible to obtain an alternating current identical in voltage with the direct current which excites the converter; this is accomplished by the use of a second set of armature windings, insulated from the direct current circuit; and the instrument becomes in reality a "Motor Dynamo" or "Motor-

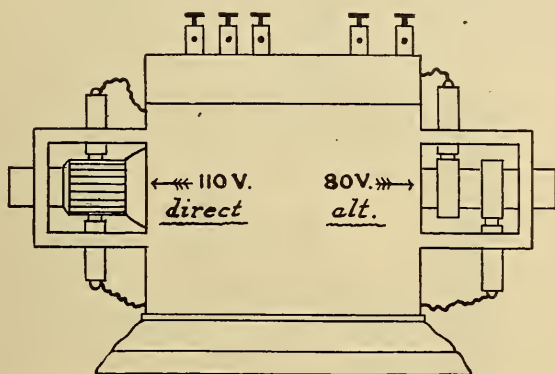

FIG. 78.—Rotary Converter, Excited by a 110 Volt Direct Current, and Generating an Alternating Current of 80 Volts.

Generator.” This construction greatly increases the expense of the converter, and, unless the High-frequency Coil is to be used on both direct and alternating currents, it will be simpler to adapt the transformer for the lower voltage of the ordinary type of rotary converter.

Physicians whose knowledge of High-frequency Currents has been derived from European textbooks will be familiar only with forms of apparatus in which the *Ruhmkorff* coil is employed, such as have been described in a preceding chapter. A number of American manufacturers have introduced outfits of the above type, some of which are equal if not superior to the productions of the best European makers. Examples of this type of appar-

atus are shown in Figs. 79 and 82. The *Ruhmkorff* coils in these outfits are of similar construction, being enclosed in a cherry or mahogany box filled with a jelly-like insulating medium. Coils of this construction, all things being considered, are less liable to injury or breakdown than those of the conventional type in which the secondary is protected by a thin sheet of hard rubber. The two coils above-mentioned are provided with large mica

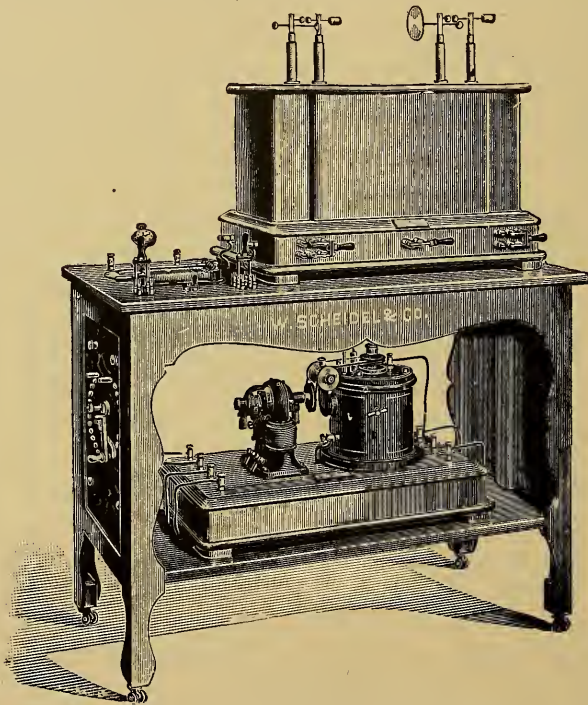

FIG. 79.—“Scheidel-Western” Coil for Exciting High-frequency Apparatus.

condensers of variable capacity mounted in a compartment beneath the coil. When used with a “*Wehnelt*” or “*Electrolytic*” *interrupter*, as in Fig. 82 (which shows a *Ruhmkorff* High-frequency Apparatus arranged for use on the alternating electric light current), the above-mentioned mica condenser is not included in the circuit; in the arrangement shown in Fig. 79, however (adapted for use with the direct current) in connection with a mercury jet or turbine interrupter, the condenser must be

employed. The "resonators" in the above outfits are of the conventional European type, and their action and adjustment are similar to those previously described.

In Fig. 81 a slightly different type of High-frequency Apparatus is shown, which combines the resonance principle of *Oudin* with the inductive action of the *Tesla-Thomson* Coil; it is called an "Inducto-Resonator," and, in the opinion of the writer, possesses some advantages over the conventional "*Oudin* Resonator."

In Fig. 82, is shown an American High-frequency outfit which, while employing the regular *Oudin-d'Arsonval* system shows many radical departures from the customary arrangement of the parts in the European appa-

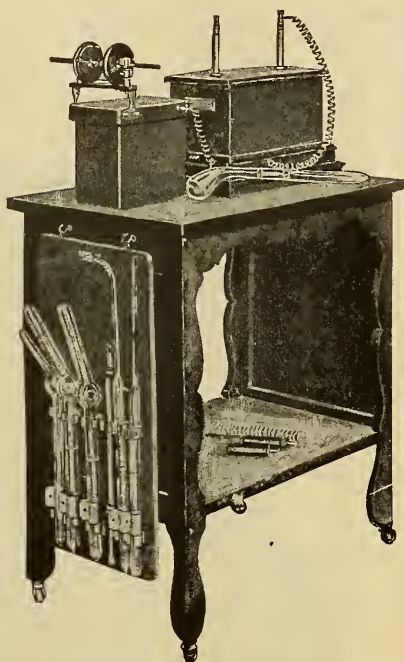

FIG. 80.—"Scheidel-Western" High-frequency Apparatus, for Use with Coil Shown in Fig. 79.

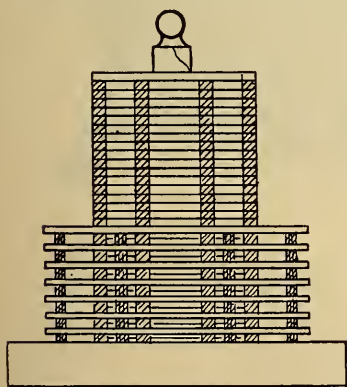

FIG. 81.—"Inducto-resonator," Involving Induction, as well as Resonance.

ratus. The resonator and solenoid are both enclosed and mounted horizontally above the *Ruhmkorff* Coil, which is embedded as those above described. The interrupter, which is of the *electrolytic* type, is enclosed in a cabinet on the side of which is a large *rheostat* for varying the primary current.

This apparatus is said to work well on either direct or alternating circuits and possesses a marked advantage in that the

Ruhmkorff and *High-frequency Coils* are combined in a single unit.

During the past few years a number of High-frequency Machines have been placed upon the market, which combine a

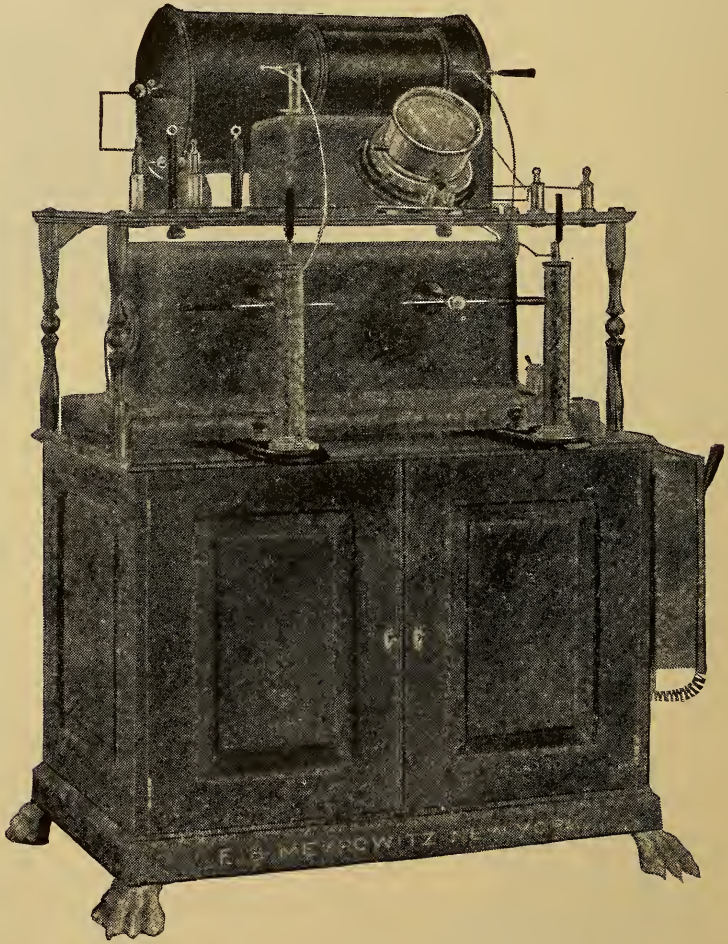

FIG. 82.—*Meyrowitz* High-frequency Apparatus.

Ruhmkorff coil with a High-frequency Transformer of the "*Tesla-Thomson*" type. The currents produced by this combination differ in a number of respects from those obtained from a typical *Tesla* apparatus (such as the writer's "*Ajax*" machine, for example), nor are they similar in character to currents from

an *Oudin* resonator; they are, however, suitable for therapeutic use in practically the same manner and for the same conditions as the currents above-mentioned. A well-known example of this class of apparatus in the so-called "*Cole Coil*," shown in

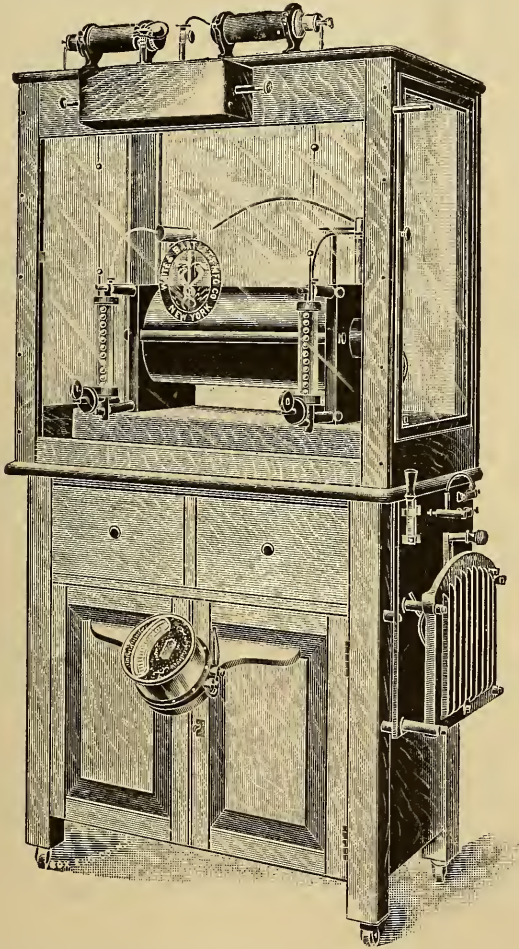

FIG. 83.—The "*Cole Coil*," for X-Ray and High-frequency Generation.

Fig. 83; the general design and arrangement of parts is the work of *Dr. Lewis Gregory Cole*, of New York City. The High-frequency Coil is a modification of *Piffard's* "*Hyperstatic Transformer*," with its primary windings altered so as to adapt

it for use with a *Ruhmkorff* Coil. The latter coil is mounted in a glass case, surmounting a square wooden cabinet containing the *electrolytic interrupter*. An ammeter is permanently fixed to the front of the cabinet and indicates the amount of current passing through the primary circuit. By means of a pulley, operated by a handle at the side of the glass case, the connection is made between the *Ruhmkorff* secondary and the *Piffard* High-frequency coil, which is mounted in the manner shown in the illustration. *Multiple spark-gaps* are provided for X-Ray purposes, and when equipped for use on the *alternating current* a "Villard Valve" and "Oscilloscope" are included in the outfit. In addition to the two *Leyden Jars* belonging to the *Hyperstatic*, there is a small accessory jar for use with the "*Piffard* Ultra-violet lamp." The frequency of the currents from the *Hyperstatic* is about the same as when a Static machine is used to charge the condensers. A convenient feature of this outfit is the use of *steel tapes* to connect the coil with the X-Ray tube, or electrodes; when not in use, these tapes are automatically coiled up like pocket tape-measures.

Heinze's apparatus is in many ways similar to the one just described as it consists of a *Ruhmkorff* Coil with its interrupter, rheostat, etc., combined with a High-frequency Transformer of the *Tesla-Thomson* type. The latter coil, however, is considerably larger and of greater power than the "*Hyperstatic*"; and is of proportionately lower frequency, the capacity of its condensers being at least four times that of *Piffard's* Apparatus. The important feature of this outfit is its *mechanical interrupter*, which is one of the best instruments yet devised for breaking the primary current of a *Ruhmkorff* coil. In the lower part of the cabinet is mounted a small transformer for cautery, and diagnostic light purposes.

The writer's contribution to the list of outfits of the "*Ruhmkorff-Tesla*" type, is the so-called "Hercules Universal," previously alluded to (see Fig. 84). In the lower part of the cabinet is a wooden box containing a twelve-inch *Ruhmkorff* coil, suitably embedded, which is wound so as to produce secondary currents of *exceptionally* high amperage. In the same compartment with the coil is an improved *electrolytic interrupter*, recently invented

by the author, so arranged as to be practically noiseless, and regulated by means of a vertical rod ending in a knob on top of the cabinet. (See Fig. 85.) A *Tesla-Thomson* coil of peculiar design, is mounted between the top of the cabinet and the plate-glass table which supports the Mexican onyx pillars of the triple terminals. The arrangement of the apparatus is such that, normally, the *Ruhmkorff* Secondary Terminals are connected to

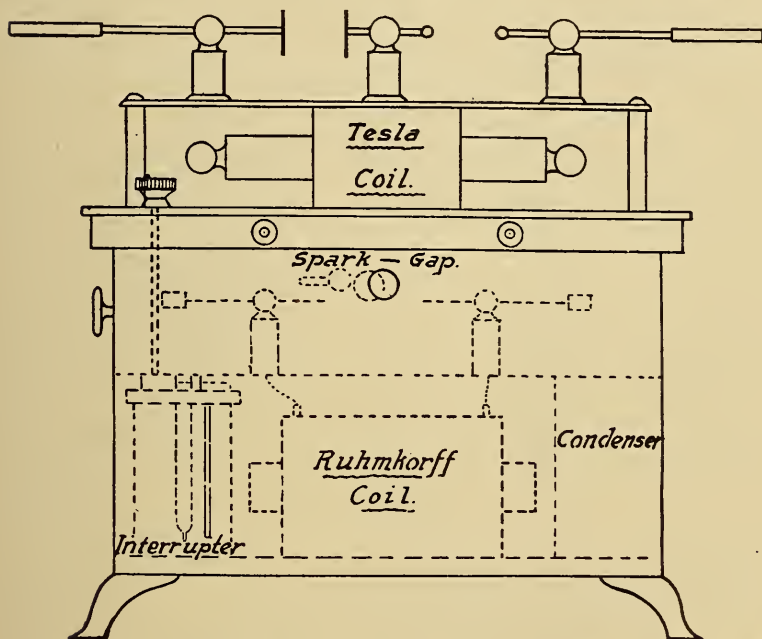

FIG. 84.—The “Hercules Universal,” the Author’s latest Apparatus for Obtaining both “Ruhmkorff” and True “Tesla” Currents, from either Direct or Alternating Service.

the High-frequency Circuit; when it is necessary to employ the *Ruhmkorff* current *directly* (as in the excitation of X-Ray tubes, for example), the two insulated knobs at either side of the central panel are pulled out, like the “Stops” of an organ, exposing the binding posts of the secondary circuit and simultaneously breaking the connection between the latter and the High-frequency Apparatus. The writer believes his apparatus to be unique in that a multiple-plate condenser and short spark-gap are substituted for the *Leyden* Jars and long, high-resistance

gap employed in all other forms of "*Ruhmkorff* High-frequency Apparatus."

When operated on the alternating current the *electrolytic interrupter* may be dispensed with (a suitable short-circuiting switch being provided for the purpose), and it would then be difficult to distinguish between the High-frequency currents and a true *Tesla-Thomson* current from an apparatus with a closed-

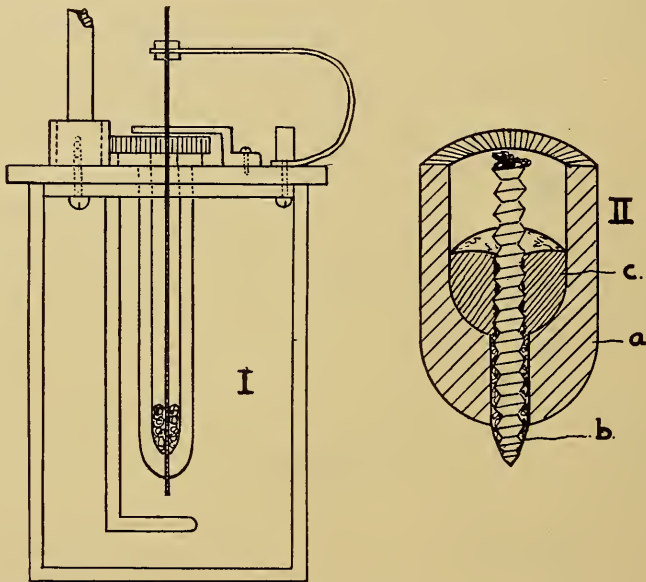

FIG. 85.—The Author's Improved Electrolytic Interrupter.

I.—General Construction. II.—Details of Anode.

a, Porcelain Tube; *b*, Threaded Copper Wire; *c*, Metallic Mercury which keeps the point of ("*b*") amalgamated by flowing around the spiral groove of the screw-thread.

circuit transformer. Even when operated on a *direct current*, with the interrupter in circuit, the High-frequency Currents from the "*Hercules Universal*" are practically identical with those of its alternating prototype except for exciting *Crooke's* Tubes in skiagraphic work; and as the *Secondary Ruhmkorff Current* is available for the latter purpose, and as it gives results decidedly superior even to those obtained with an *alternating Current High-frequency Apparatus*, it will be readily seen that this difference is of no practical importance. For all therapeutic

purposes, including X-Ray therapy, the High-frequency Currents from the above machine are of equal value and are employed in the same manner as the currents from a standard "Ajax" or "Hereules" Coil.

One very great advantage of the "Hereules Universal" is that it dispenses with the cumbrous and costly "Rotary Converter"; it may also be commended from the fact that it may be operated, as desired, on either an alternating, or a direct current. For those who are desirous of comparing the action and therapeutic value of High-frequency Currents of the "*Tesla-Thomson*" type with those of *Oudin*, or *d'Arsonval*, the above outfit is especially useful, as it readily admits of the use of separate solenoids and resonators, which may be used alternately with the *Tesla* Coil by the employment of the two "organ stops," above described.

This apparatus, which will be placed upon the market within the next few months is the product of several years research and experiment on the part of the author, who formerly believed it to be practically impossible to produce from a *Ruhmkorff* outfit High-frequency Currents of the same general character as those obtained from a typical *Tesla-Thomson* Coil, excited from an *alternating current transformer*.

The final solution of the problem was obtained through the use of a *Tesla-Thomson* coil of a peculiar and unique winding, in connection with an especial form of *spark-gap*, and a *Ruhmkorff* Coil giving secondary currents of high amperage.

CHAPTER X

ANALYSIS AND COMPARISON OF HIGH-FREQUENCY CURRENTS FROM DIFFERENT FORMS OF APPARATUS

IN order to obtain an intelligent idea of the physiological and therapeutic action of a given type of High-frequency Current, it is necessary to accurately analyze the method by which the current is generated, and to study it from a physical and mathematical standpoint. The "Graphic Method," previously explained, will be found of great assistance to a clear comprehension of the difference between the currents generated by the various types of apparatus which have been described in the preceding chapters.

The factors which determine the qualities of a High-frequency Current are as follows:

- (a) Capacity of the Condensers.
- (b) Potential or Voltage of the Charging Current.
- (c) Rate of Charge, or the number of *Primary Discharges* per second.
- (d) Inductance of the Discharging Circuit, depending upon the size of wire, and the diameter and number of turns in the Solenoid, or *Primary Tesla Coil*.
- (e) The length of the Spark-gap and the nature of its Terminals and the rapidity with which these Terminals conduct away the heat generated at each *Primary discharge*.
- (f) The Diameter and number of Turns per inch and the total length of the Resonator, or *Secondary Tesla Coil*, as compared with the number of Turns of the Solenoid or *Tesla Primary*.

While the frequency of a current is primarily a function of the capacity of the condenser, its physical characteristics are affected to a large degree by the rapidity with which the condenser regains its charge, and the persistence of the secondary oscillations. For example, the discharge from the writer's "Hercules,"

or "Ajax" machine, forms a true *arc*, or *electric flame*, quite different from the snappy spark-like discharge of a High-frequency Coil excited by a static machine. (Fig. 86.) The discharge from an *Oudin* resonator assumes an appearance midway between these two extremes, being less tortuous and branching than the "Static" high frequency, yet lacking the smooth continuous outline of the arc from a *Tesla* apparatus. In the latter machine, the small *ohmic resistance* of the spark-gap,

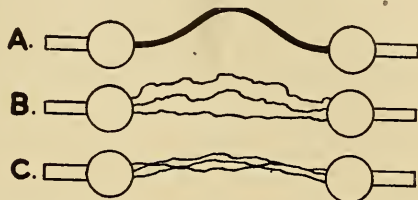

FIG. 86.—The High-frequency Discharge. A, "Tesla Arc." B, "Hyperstatic Spark." C, "Oudin" Discharge.

and the large volume, or amperage of the charging current, combine to produce a practically continuous series of oscillations, as a second primary discharge occurs before the secondary oscillations which succeed the first initial discharge have entirely died out. This continuous current is shown graphically by the curve "A"

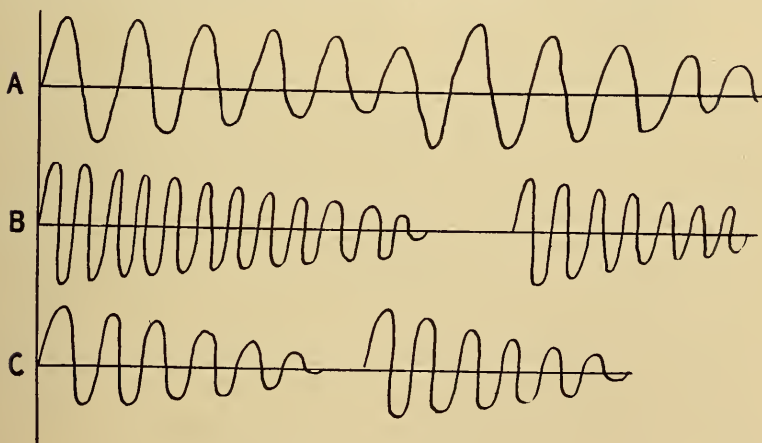

FIG. 87.—Graphic Tracings of High-frequency Currents.

A, Current from Author's "Ajax Coil." B, "Hyperstatic" Current. C, Oudin Discharge.

(Fig. 87), which gives an approximate idea of the character of the discharge from a *Tesla* coil. It is, in fact, a true *alternating current of High-frequency and High-potential*, while the current from a Resonator, or Static High-frequency Apparatus is com-

posed of groups of diminishing oscillations, separated by periods during which no current passes. The low amperage of the static machine makes it impossible for the condensers to recharge with any degree of rapidity, and the intervals between the different sets of oscillations are necessarily much longer than the period occupied by each group of oscillations. This is graphically represented by the curve "B" (Fig. 87). The curve "C" (Fig. 87) represents the discharge of an *Oudin* resonator operated by a *Ruhmkorff* coil. As the current from the latter has a relatively large volume, the condensers would be recharged very quickly, were it not for the fact that the spark-gap possesses a very high *initial resistance*, and a slight interval is necessary to

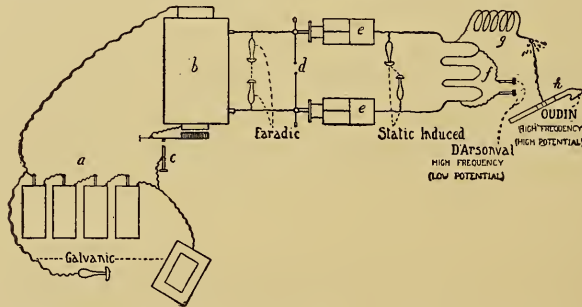

FIG. 88.—Arrangement for the Production of Oudin-d'Arsonval Currents.

enable the condensers to acquire a sufficiently high potential to overcome this resistance.

By graphically representing the different stages involved in the production of a High-frequency Current, we obtain a clear conception of the exact nature of the various steps of transformation. In Figs. 88 and 89 are shown the arrangement of a typical *d'Arsonval* Apparatus and of a *Tesla* High-frequency Apparatus. In Fig. 90 is shown graphic representations of the different currents produced in the two types of apparatus. In the *d'Arsonval* apparatus, we start with a continuous unidirectional current of low voltage and high amperage, derived in the illustration from battery cells connected in series. It is, in other words, a "Galvanic Current," and is graphically represented by the straight line "A" (Fig. 90). By means of the magnetic break shown in Fig. 88, this current is converted

into an interrupted galvanic, or primary Faradic current, as shown at "B" (Fig. 90). The impulses being in the same direction are all above the horizontal abscissa line. This current, acting on the soft iron core, periodically magnetizes the latter, and a high voltage, low amperage current is induced in the secondary coil. By reference to the curve "C" (see Fig. 90), it will be seen that this secondary Faradic, or *Ruhmkorff* Current consists of periodic impulses above the line, separated by weaker impulses below the line; the latter resulting from the completion of the primary circuit, which magnetizes the iron core, and the former, stronger impulses being induced by the *sudden loss of magnetism* at each "break" of the circuit. A secondary Faradic, or *Ruhmkorff* current is therefore an *Induced, Interrupted, Un-*

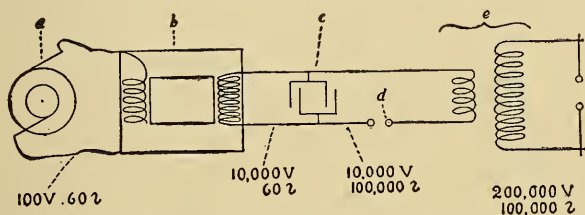

FIG. 89.—Arrangement for the Production of Tesla-Thomson Currents.

symmetrical, Alternating current of relatively *high voltage*, and relatively *low frequency and amperage*. This current passes to the *Leyden Jars*, which discharge across the spark-gap "G." If the outer coating of the jars be connected to two sponge-covered electrodes in contact with the human body, a "*Morton static-induced current*" will pass through the patient. This current would be oscillatory, were it not for the high resistance of the patient's body, which damps the oscillations, practically obliterating all but the primary or initial impulses. An interrupted pulsatory current of relatively low frequency is thus produced as shown in "D" (Fig. 90).

If the outer coatings of the *Leyden Jars* be connected by a coarse wire coil or solenoid, a path of low resistance and large inductance is formed, through which the condenser discharges in a series of undamped oscillations. The *d'Arsonval* Current thus produced is oscillatory, of high frequency, moderately high

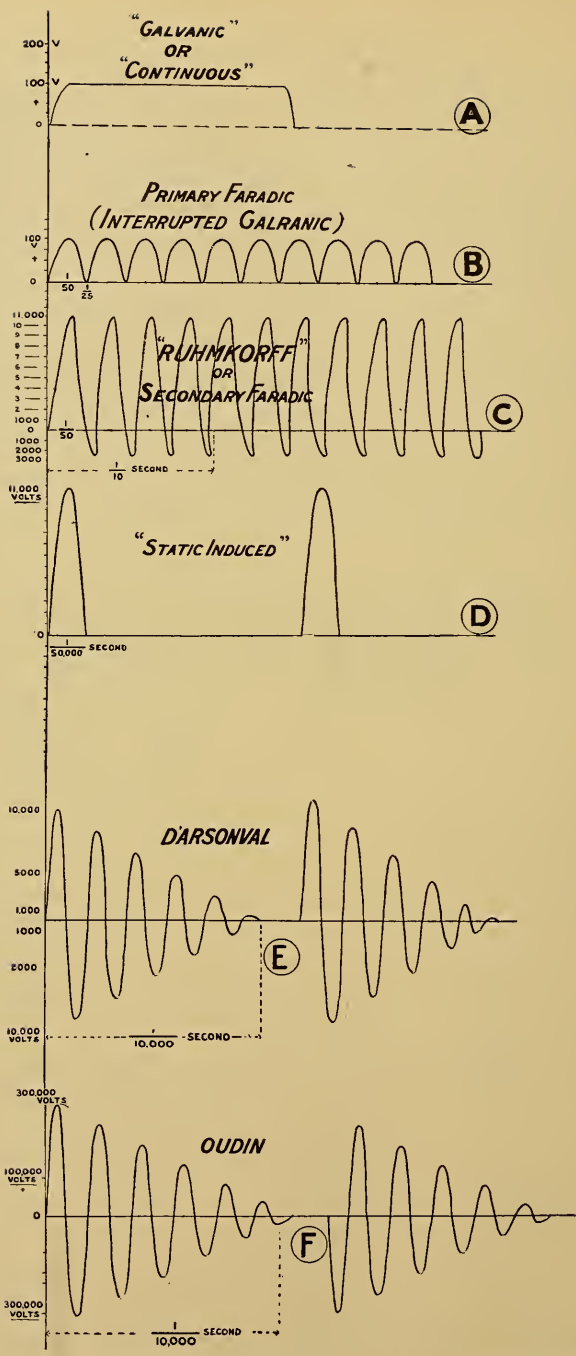

FIG. 90.—Graphic Representations of the Various Currents Illustrated in Figs. 94 and 95.

A, "Galvanic" or "Continuous." B, "Interrupted Galvanic" or "Primary Faradic." C, "Secondary Faradic" or "Ruhmkorff." D, Static Induced. E, D'Arsonval. F, Oudin. (See opposite page for continuation.)

voltage and relatively high amperage. It is represented by the curve "E" (Fig. 90).

At "F" is a graphic tracing of the discharge of an *Oudin* resonator excited by the solenoid above mentioned. The current is similar in frequency to the *d'Arsonval* Current, but its voltage is much higher, and its amperage much lower.

The *Tesla* Apparatus shown diagrammatically in Fig. 89, is excited by a commercial alternating current of about 100 volts, and a frequency of 60 cycles per second. It is graphically represented by the curve "G" (Fig. 90). It may be described as an

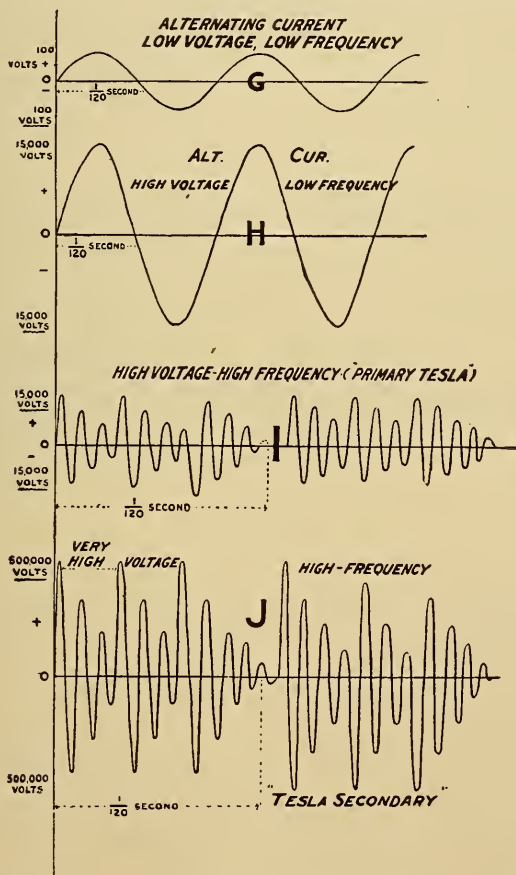

FIG. 90.—Continued.

G, Low-frequency, Low-voltage, Alternating Current. H, Low-frequency, High-voltage Alternating Current. I, *D'Arsonval* or Primary Tesla. J, Tesla Secondary; High-frequency and Very High Voltage.

alternating current of large amperage, low voltage and low frequency. The alternations are symmetrical and the current is of sinusoidal type.

The curve "H" represents the current induced in the secondary coil of the step-up transformer. It resembles the preceding current except that its voltage is much higher and its amperage proportionately lower. It is therefore an alternating current of low amperage, low frequency and moderately high voltage.

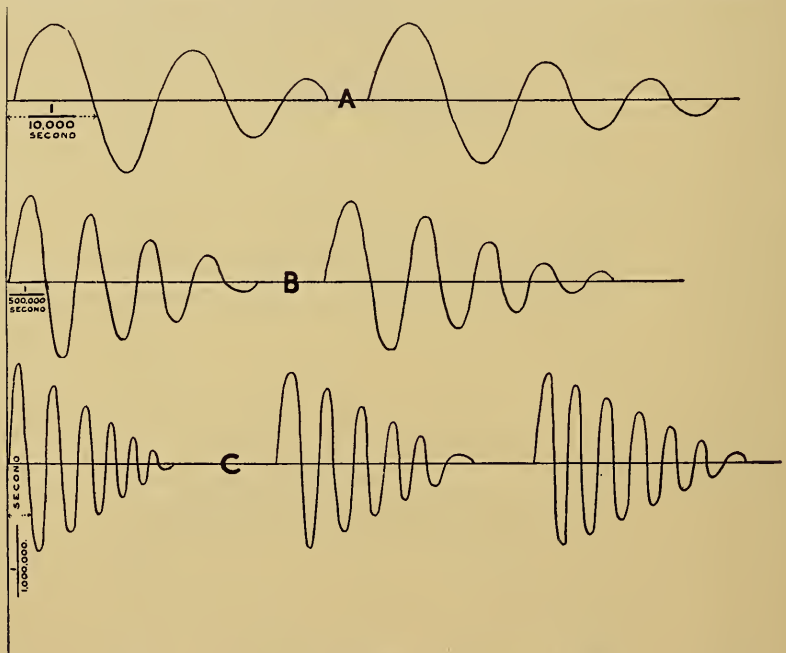

FIG. 90 (continued).—Tracings Showing Frequencies of Different Apparatus. A, Kinraide Coil Current. B, Ajax Coil Current. C, Hyperstatic Current.

This current passes into the condenser which discharges through the primary solenoid in series with the spark-gap "G." A current of the *d'Arsonval* type is thus produced differing only from that obtained from a *Ruhmkorff* High-frequency Coil, in that the oscillations are practically continuous, and the voltage somewhat less. It is shown graphically in curve "I," and may be described as an alternating current of great frequency, moderately high voltage and relatively high amperage.

The current from the secondary, or High-tension *Tesla* Coil is of the same frequency as the current in the primary, but its voltage is much higher and its amperage lower. It is represented graphically by the curve "J" (Fig. 90).

In the above diagrams it has been necessary to employ different scales, as indicated, in order to show the curves within the limits of the available space. In some curves, as in that of the Static-Induced, different scales are employed for the *oscillations*, and for the *spaces between the sets of oscillations*. For example, if the scale employed in the case of the low-frequency alternating current shown in the curve "G," were used in connection with the *Tesla* Current in the curve "J," the abscissa line in the latter would have to be nearly one hundred feet long.

The difference in the frequency of the High-potential Currents, obtained from different types of High-frequency Apparatus is illustrated by the curves shown in Fig. 90, page 130.

"A" represents the discharge from a *Kinraide* Coil which is of the lowest frequency of any oscillatory apparatus on the market.

"B" represents the current from one of the writer's "Ajax" or "Hercules" machines, the frequency of which is very much higher than the preceding.

"C" represents the current from the *Piffard* hyperstatic transformer which has perhaps the highest frequency of any therapeutic *Tesla* apparatus.

CHAPTER XI

THE PHENOMENA AND PHYSICAL PROPERTIES OF HIGH-FREQUENCY CURRENTS

MANY of the apparently paradoxical effects produced by High-frequency Currents may be easily understood if we bear in mind the fundamental difference between the rapidly oscillating, and the ordinary continuous or Low-frequency Currents. In the latter, streams of electrons move through the conducting medium as water flows through a pipe; and, naturally, friction is developed between the stationary and the moving particles. If the stream of electrons is of great volume and of sufficiently high voltage, it will produce intense heat in a metallic conductor, and in case of a poor conductor, like the tissues of the human body, it will actually disintegrate the more delicate structures such as the nerve cells and fibers. Alternating currents of low frequency may be regarded as direct currents which are periodically reversed; during each alternation the individual electrons would travel hundreds of feet, or even miles before the cessation of the impulse. In a High-frequency Current, however, especially when produced from condensers of small capacity, the duration of each oscillation is so extremely small that the individual electrons travel but a short distance before their direction is reversed. So sudden and intense is their motion, however, that their momentum is communicated to other electrons in the atoms at the end of their path, and these in turn are shot out for a short distance, transmitting their motions to still other electrons, and so on through the entire circuit. A High-frequency Current is, in fact, a form of radiant or vibratory energy, the waves or vibrations being transmitted through the length of the circuit, while the individual electrons simply swing back and forth in arcs of small amplitude like minute pendula. This explanation has been given in a previous chapter in order to

show how the High-frequency currents could apparently flow through glass, rubber and other non-conductors. It also explains the immunity of the human body to currents of large volume and high frequency, while instant death would result from a current of the same voltage and amperage but of *Low* instead of *High* frequency.

Another reason why High-frequency Currents are less harmful is because of the limited sensibility of the nerves, which respond only to impulses of comparatively low frequency. This will be further discussed in the chapter on "Physiology."

The inductive resistance of a conductor increases with the frequency of a current. For this reason coils or loops of wire having little or no resistance for direct or Low-frequency Currents would oppose the passage of currents of great frequency almost to the same extent as a mass of non-conducting material. The effects of inductance are therefore the most characteristic and interesting of the physical properties of High-frequency Currents.

The phenomena of High-frequency Currents are usually considered under the following headings:

- (A) Phenomena due to Induction.
- (B) Electro-Static Phenomena.
- (C) Electro-Dynamic Phenomena.
- (D) Phenomena of Resonance.

(A)

Phenomena of Induction

As has been stated, the inductive action of a current increases with its frequency. For example, a current of one ampere and a frequency of five hundred thousand produces the same inductive effect in a single turn of wire, that a current of one hundred amperes and a frequency of fifty would produce in one hundred turns of the same wire. (*Denoyes.*)

The inductive action of High-frequency Currents is best studied by the use of a current of the *d'Arsonval* type, but the secondary current from a *Tesla* Coil will produce practically the same results. If an ordinary incandescent lamp bulb be con-

nected to the two sides of an arch of heavy copper wire, connected to the terminals of a *d'Arsonval* solenoid, the lamp will be brought to full incandescence, although the ohmic resistance of

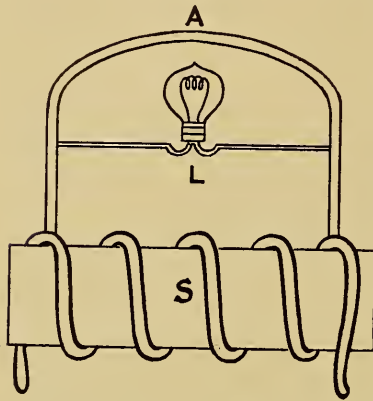

FIG. 91.—Lamp (*L*), Lighted by the Current “Backed Up” by the Impedance of the Heavy Copper Arch (*A*), Attached to the *d'Arsonval* Solenoid (*S*).

the copper arch is less than one one-thousandth of an ohm. (See Fig. 91.) If the lamp be connected to two adjacent turns of a *d'Arsonval* solenoid, it will be illuminated in a similar manner.

If a lamp be connected to two metal electrodes and held between two persons, each of whom is connected to a terminal of the solenoid, the lamp will be brought to incandescence by the current passing through their bodies.

The experiment also illustrates the dynamic properties of a High-frequency Current, and the ease with which they travel through conductors of high resistance. If a large insulated copper wire be wound into the form of a ring or hoop three feet in diameter, and containing

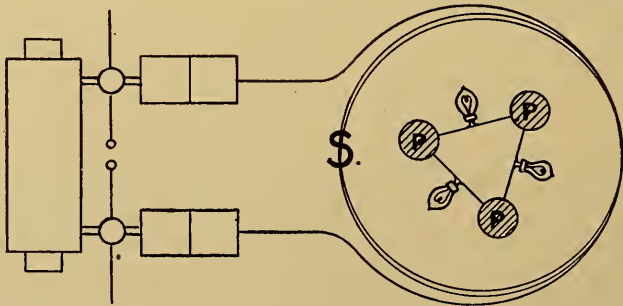

FIG. 92.—Incandescent Lamps lit by Currents Induced in Closed Circuits formed by three persons (*P, P, P*) standing inside of Large Solenoid (*S*).

from five to ten turns, and this hoop be connected to a High-frequency Apparatus in place of the regular solenoid coil, a strong magnetic field of force is produced in its vicinity. If the

operator stands inside this ring, holding in his hands the terminal wires of the incandescent lamp above-described, the latter will become illuminated by the High-frequency Current induced in the closed circuit, formed by the arms and body of the operator. If a large wire be conducted several times around the sides of a small room, and connected as above, the experiment may be performed by several persons forming a circuit in the center of the room, small lamps being held between them (see Fig. 92). If desired, *Geissler Tubes* may be substituted for the lamps in the above experiment.

(B)

Electro-Static Phenomena

If the terminal of a *Tesla Apparatus* or an *Oudin Resonator* be connected to the body of a patient, by means of an insulating conducting cord and a metal hand electrode, a powerful rapidly alternating electro-static field will be formed extending to a

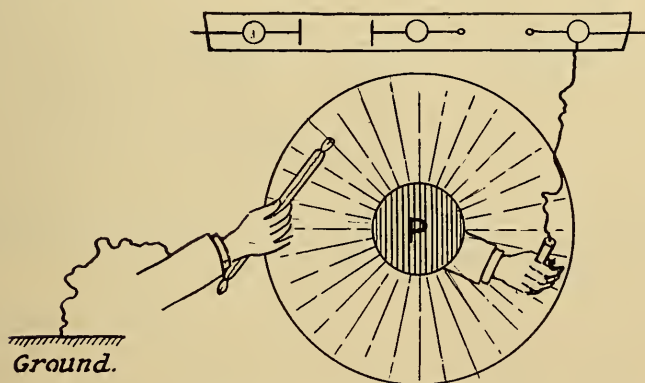

FIG. 93.—Geissler Tube Illuminated on the "Electrical Aura" or "Vibratory Field" Surrounding a Patient, (P), Connected to a Terminal of a Tesla Coil.

distance of from two to ten feet, according to the strength and frequency of the current. (Fig. 93.) A *Geissler Tube* held in the hand of the operator will become brilliantly illuminated when brought within the aura of electrical vibration, and streams of purple light may be seen radiating from the fingers of the patient when his free hand is extended toward any conducting body. It is

not necessary that the patient should be insulated by means of a glass-legged platform as in the case with electricity from a static machine, inasmuch as the patient's body is giving out *electrical vibrations* rather than *streams of electrified particles*. If a glass bell-jar be placed over the patient's arm, or if a plate of window glass be laid upon his extended palm, sparks may be drawn by presenting a metal object to the outer surface of the glass, and *Geissler Tubes* may be excited from the transmitted vibratory energy. If a metal plate of tin or zinc, cut into the form of a six-pointed star, be suspended from a cord and con-

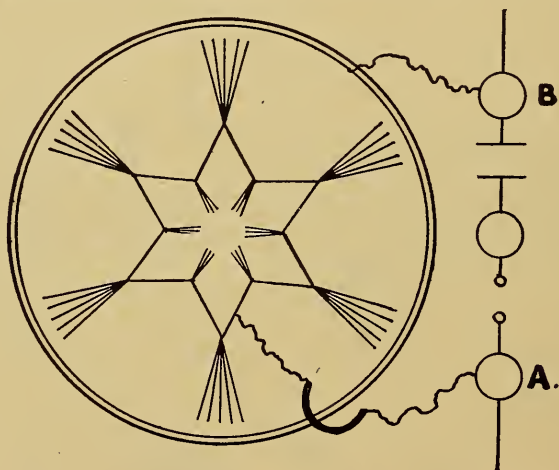

FIG. 94.—Beautiful Effluve from the Points of a Skeleton Star Cut from Tin or Bent from Wire and Enclosed in a Larger Circle of Brass Wire, the Star and Circle Being Attached Respectively to the Poles A and B of a Tesla Coil.

nected to a terminal of a *Tesla Coil*, it will become brilliantly illuminated, sending out long purple streams from its points and edges. (Fig. 94.) The experiment may be made still more brilliant by placing the star in the center of an insulated wire ring several feet in diameter, connected with the opposite terminal of the *Tesla Coil*.

If two tinsel cords be stretched across the room, several feet apart, and each cord be connected to a terminal of a *Tesla Coil*, they will become surrounded with an aura of purple light of equal intensity throughout their entire length. A variation of the above experiment is to form a length of tinsel cord or fine

insulated magnet wire into the written letters of a word or name by pressing the wire upon the adhesive surface of a plate of glass coated with shellac varnish. By coating the back of the glass

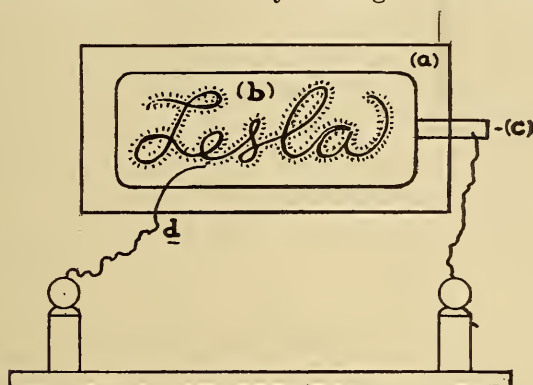

FIG. 95.—Illuminated Sign, Formed by the Effluve Given off from the Fine Wire (*d*) Arranged to Form the Word (*b*), Adhering to the Shellacked Surface of the Glass Plate (*a*). A Sheet of Tin-foil Covers the Back of the Glass and is Connected to a Tesla Terminal by Means of the Copper Strip (*c*), the Opposite Terminal Being Connected to the "Wire Word," (*b*).

with a sheet of tin-foil and connecting the latter with one terminal of the *Tesla* Coil, the wire or tinsel cord being attached to the other terminal, the word or name will appear in characters of purple light which will be plainly visible in all parts of a large lecture hall. This experiment was first performed by *Tesla* in his lecture before the Royal Society of Engineers in 1891. (Fig. 95.)

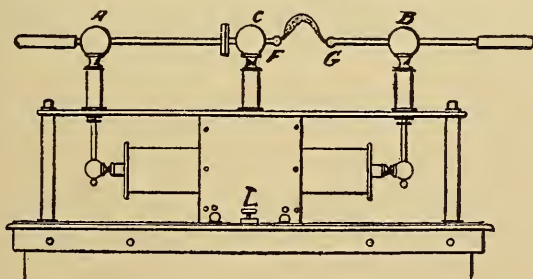

FIG. 96.—Terminals of the Author's Apparatus Arranged to Show the "Arc" Discharge.

The discharge of a High-frequency Coil of the *Tesla* type is conveniently studied by the writer's triple terminals with which all of his machines are provided. (See Fig. 96.) The outside

terminals, "A" and "B," are connected respectively with the two poles of the *Tesla* coil. The center post "C" is called the "Dummy," as it is insulated from the rest of the machine; a small brass ball is attached to its right-hand side which cooperates with a similar ball on the end of a brass rod which slides in the terminal "B." A brass disk on the other side of the "Dummy," faces a similar disk on the end of a rod sliding in the terminal "A." With the balls and disk in contact the *Tesla* Coil will be short-circuited through the "Dummy."

If a gap of several inches be made between the small balls by withdrawing the sliding rod "B," the discharge will occur in the

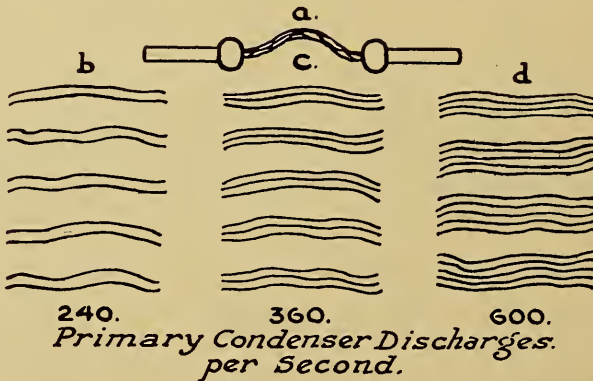

FIG. 97.—*a*, "Arc" Between Terminals of "Ajax Coil," *b*, *c*, *d*. Same Arc as Viewed in a Tilting Mirror.

b, Weak Current, wide Spark-gap. *c*, Moderate Current, Medium Spark-gap. *d*, Stronger Current, Shorter Spark-gap. (Each or the Parallel Lines Represents one Complete Series of Oscillations, or one Complete Condenser Discharge.)

form of a characteristic High-frequency "Arc," or curved pencil of *electric flame*. That it is actually a flame may be seen from the fact that it gives out considerable heat, sufficient to melt a wax candle held several inches above it, and capable of igniting a stick of hard wood held in its path. It also causes combustion between the oxygen and the usually inert nitrogen of the air, the various oxides of nitrogen being formed. While apparently continuous, the arc in reality consists of a rapid succession of separate discharges. This can be demonstrated by viewing the arc in a tilting mirror, or by allowing it to form between upwardly diverging knife edges; it will be seen as symmetrical groups

separated by dark spaces as shown in Fig. 97. The small dark spaces between the arc in a single group represent the secondary oscillations of each condenser discharge, while the large dark spaces between the groups represent the zero points in the original exciting current, and occur one hundred and twenty times per second (if a 60-cycle current be used).

A similar phenomenon of a more spectacular character is obtained by revolving a long slender *Geissler Tube* extended radially from a metal shaft connected to one terminal of the

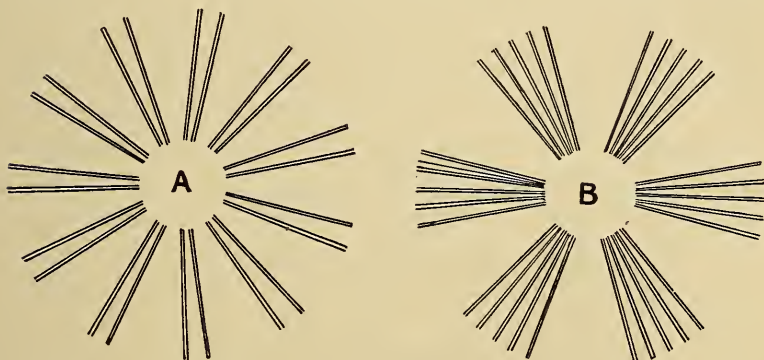

FIG. 98.—Appearance of Rapidly Revolving Narrow Geissler Tube Connected to Terminal of "Ajax Coil."

A, Wide Gap; Weak Current. B, Strong Current; Short Gap.

Tesla Coil. A beautiful wheel of light is thus formed as indicated in Fig. 98.

By separating the small balls as far as possible and opening the spark-gap, the discharge will occur in the form of a branching zigzag line of light. The writer has called this the "Pseudo-Static Spark," inasmuch as it closely resembles the discharge of a *Holtz Machine* except that the bright white portion next to the positive pole in the static spark, occurs in the center of its High-frequency counterpart. (Fig. 99.) This experiment is especially brilliant if performed with the writer's "Hereules" which has a rotary spark-gap. The difference between the "Arc" and the "Pseudo-Static Spark" is due to the fact that the secondary oscillations of each condenser discharge are almost entirely damped or suppressed in the production of the latter phenomenon. A number of other interesting experiments may be performed

with the arc discharge. The intense heat which it produces has already been mentioned. One way of demonstrating this property is to attach a fine iron wire to the sliding rod so that it projects for about an inch toward the "Dummy;" adjust the rod so that an air gap of about one-half inch long is formed between the end of the wire and the ball on the middle post. Now, start the machine and almost instantly the wire will become incandescent and actually burn with brilliant scintillations until the projecting portion is consumed or melted into a small iron ball.

This experiment may be shown in a still more striking manner if the wire be held in a pair of pliers in the right hand of the operator, and the arc formed between the end of the wire and a key or other metal object held in the hand of a second person.

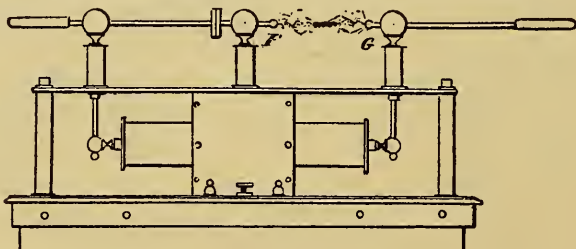

FIG. 99.—"Pseudo-Static Spark" from the Author's Hercules Machine.

The machine is started with the disks and balls widely separated and the current is drawn into the body of the operator by bringing a metal rod held in the left hand in contact with either terminal of the *Tesla* Coil. The arc at the end of the wire should be very short, otherwise the experiment will not succeed. The spark-gap should be as short as possible in order to obtain a continuous series of oscillations.

If a sheet of stiff writing paper be waved rapidly to and fro in the arc formed by separating the small balls from one to two inches, and then removed and examined with a magnifying glass, the sheet will be seen studded with innumerable minute punctures much finer than those produced by the point of the most delicate needle.

Start the machine with the small balls in contact and the disks separated by an air-gap of from three to five inches. The

discharge will then occur as an "Effluve" or "Brush," resembling a cylinder of purple light with bulging sides. With a short spark-gap the effluve will be seen to consist of innumerable hair-like threads of purple light; with a long spark-gap the effluve is less dense, and brilliant purple snake-like streamers will radiate from the edges of the disks.

This effluve consists of alternating streams of electrical particles moving with enormous velocity and momentum. The intense sensory impression experienced when the effluve is employed therapeutically results from the impact of the rapidly moving particles upon the surface of the body. So intense is this molecular bombardment that actual blistering is produced if the treatment is continued more than ten minutes.

By isolating or separating the two streams of the effluve so as to obtain the effect of the particles moving in one direction only, a fair idea may be obtained of the amount of mechanical energy which is liberated in this discharge. The writer discovered by accident that a smooth piece of *perfectly flat* cardboard placed in close contact with the surface of the disk "D" blocks most of the electrical particles which would be ordinarily shot out from the surface of the latter, while those emanating from "E" plunge across the air-gap and expend their force upon the surface of the card. As a result the latter will be held as if glued to the disk "D," and considerable power will be necessary to remove it until the machine is stopped when it will fall off by its own weight. The experiment should be performed with the small balls "F" and "G" in contact, and the disks separated by a gap of from two to five inches.

A peculiar characteristic of High-frequency Currents is their tendency to discharge into the air, as if each pole were an independent source of energy. The higher the frequency the more marked is this independence, and coils have been constructed in which the discharge showed no tendency to jump from one terminal to the other even though the latter were in close proximity. A *Tesla* coil may therefore be regarded as two resonators, discharging or oscillating in unison but with opposite polarity. (Fig. 100.)

The monopolar effluve is best studied with an *Oudin* Resonator

or a *Tesla* Coil which has one terminal connected with the ground. If a hollow cone of tin-foil terminating in a pointed wire or needle, is placed upon the terminal post and all parts of the latter are wrapped in rubber cloth so that the discharge can escape only from the needle, a brilliant bouquet of purple streams

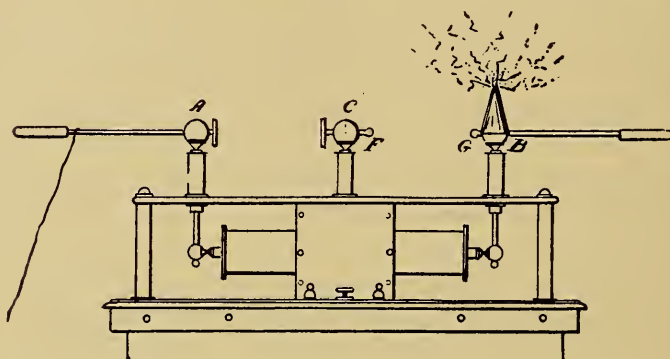

FIG. 100.—Resonator Discharge from Terminal of Tesla Coil.

will shoot out from the latter, resembling a miniature volcanic eruption. The needle may be regarded as a source of vibrating energy which increases the motion of the electrons and atoms in the air above the terminal and causes them to transmit or induce radiating ether waves, some of which we sense as heat and light.

(C)

Electro-Dynamic Phenomena

In order that a High-frequency Current shall flow through a conductor, it is not necessary that a circuit should be formed, as in the case of the currents of the continuous and low-frequency types. Anything that will act as an electrical condenser, in other words, any "Capacity" whether insulated or grounded, will cause a High-frequency Current in a wire connecting it to a resonator or *Tesla* terminal. This may be demonstrated experimentally in a number of ways.

For example, if a sheet of tin or zinc, several feet square, be suspended in the air by means of a non-conducting cord, and connected to a terminal of a *Tesla* Coil by an insulated copper wire, a High-frequency Current will flow through the latter

which will be of even greater strength than the current which flows in a wire directly connecting the two terminals of the coil. This effect may be understood by imagining each terminal of the coil as the termination of a pipe connected with an elevated reservoir full of water; the insulated capacity may be compared to a bag of thick cloth, the mouth of which is tied snugly around the open end of the pipe connected with the reservoir. The wire connecting the plate to the terminal may be compared to the extension pipe just mentioned which joins the "Terminal Faucet" to the bag. On turning on the faucet, the water will be forced through the pipe into the bag, and when the latter is completely filled the water will begin to ooze through its pores, running off its outer surface, and thereby establishing a continuous flow of water through the connecting pipe. This is exactly what occurs in the electrical experiment but the current or stream consists of vibratory electrical energy instead of water. The larger the bag the greater the oozing surface, consequently a greater volume of water would flow through the pipe. If a piece of thick cloth be stretched tightly over the open end of the pipe the oozing surface will be so small that practically no current will be established in the pipe. This is analogous to the condition of the insulated wire in the above experiment, when the plate to which it is connected is reduced to an extremely small size. If we imagine the distended bag to be surrounded by super-heated dry air, the analogy will become still more perfect inasmuch as the water which oozes through the cloth is instantly converted into steam, which radiates in a cloud from all parts of the bag. This radiating nebula is very similar to the vibratory aura or the rapidly alternating electro-static field given off by the insulated plate or by the body of a patient connected to a terminal of a *Tesla* Coil. (See Fig. 101.)

That an electrical current of high voltage and considerable amperage actually flows through the wire connecting the plate to the terminal may be demonstrated in a number of ways. If the wire be cut at its middle point, and the two ends united through a hot wire mil-ammeter the latter will register a current from one-twentieth to one-half an ampere. If an ordinary

sixteen-candle power incandescent lamp be substituted for the meter, its filament will become incandescent. A fine iron or platinum wire similarly connected will become white hot and may even be melted. All of the above experiments demonstrate the high amperage of the current. In order to demonstrate the great voltage of the current in the wire, different means must be employed from those used with continuous or Low-frequency Currents. Up to the present time no satisfactory instrument has been devised, but while we cannot measure it accurately

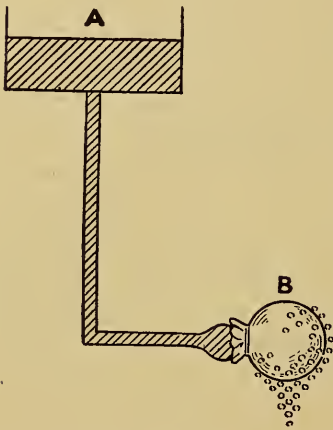

FIG. 101.—Water from Reservoir (a), Oozing Through Flannel Bag (b), Tied Around Mouth of Pipe; Illustrating the Flow of a High-frequency Current Through a Wire to an Insulated Metal Plate.

it is easy to demonstrate that the current in the wire is of extremely high potential. For example, a series of *Geissler Tubes* joined by short wires will be brilliantly illuminated when used as a bridge between the severed ends of the wire. An X-Ray tube may be excited in a similar manner, and if the two ends of the wire be brought within a few inches of each other the gap will be bridged by the current in the form of a flaming arc.

Another way of demonstrating the voltage of a current is to form a chain of a dozen persons, linked together by an equal number of *Geissler Tubes*. If the operator grasp the free end of the tube held by the last man in the chain, and then connect himself with the *Tesla Terminal* by means of a metal rod held in his other hand, every tube in the entire chain will become illuminated. A High-potential Current from a static machine on the other hand will pass at once through the operator's body into the ground so that even the first tube in the chain would be faintly if at all illuminated. *Tesla* has succeeded in operating an electric motor by a High-frequency Current of the above description flowing through a single wire as in the experiment just described.

One of the strangest properties of a High-frequency Current is the ease with which it apparently flows through sheets of glass, hard rubber, or other non-conducting substances. If a sheet of plate glass of moderate thickness be placed in front of

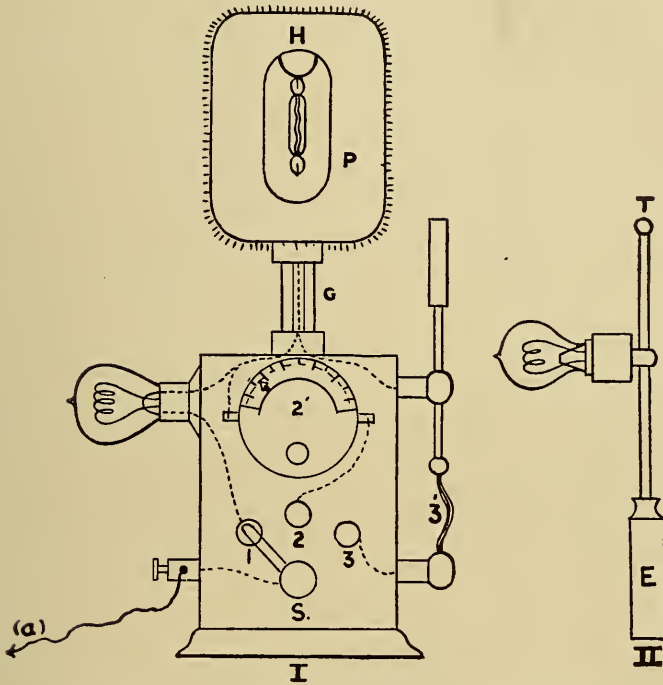

FIG. 102.—The Author's Apparatus for Demonstrating the Electro-dynamic Phenomena of High-frequency Currents.

- I.—By means of the Switch (s), the Current brought from the Tesla Terminal through the cord (a), may be sent to the Metal Plate (P), which is supported upon the glass pillar (G), by way of either the Lamp (1')—the Milliameter (2')—or the Spark-gap (3').
- II.—Device for showing the above Phenomena, in which the Operator takes the place of the Metal Plate, and in which the Current drawn from the Tesla Terminal by the ball (T), passes through the Lamp into Body of the Operator by way of Metal Hand-Electrode (E).

one of the *Tesla* Coil Terminals, and the base of an incandescent lamp with the metal shell held between the thumb and finger, be brought close to the outer surface of the glass, a spark will jump from it to the brass facet on the bottom of the lamp and passing through the filament into the operator's body will cause the lamp to glow, although not with its full efficiency. (Fig. 102.)

With the disks closed, insert a plate of glass in the gap formed by separating the small balls about one-half inch. On starting the machine the current will pass through the glass forming a beautiful rosette of radiating sparks on each side of the plate. The intensity of the transmitted vibration will cause the glass to become gradually heated, thus increasing its conductivity and gradually contracting the area through which the discharge passes. Ultimately the entire current will pass through a portion of the plate in a direct line between the balls and in several minutes the discharge will have actually melted the center of the glass forming a minute channel or aperture with smooth sides and edges quite different from the puncture produced in a plate of glass by a powerful *Leyden Jar* discharge. Care should be taken in performing the above experiment as the unequal heating of the glass plate sometimes causes it to crack with almost explosive violence. For this reason a piece of annealed window glass is perhaps better suited than the thick plate.

By laying a sensitive photographic plate face upward on a metallic or conducting surface and placing one or more metal objects such as a key, scissors, etc., upon the sensitive film, a beautiful electric autograph of the articles may be obtained by conducting a High-frequency Current to them through a fine copper wire. The current should be allowed to flow for the merest fraction of a second; a quick throw of the switch in and out of contact will be sufficient to produce a beautiful picture on developing the plate. In Fig. 103 is shown a High-frequency autograph of a pair of ordinary artery forceps which was prepared in the writer's laboratory several years ago.

(D)

Resonance Effects

The phenomena of electrical resonance in connection with High-frequency Currents have already been discussed in a preceding chapter. The electrical oscillations in a High-frequency Discharge produce waves of radiant energy in the ether having the same frequency of vibration. If these ether waves

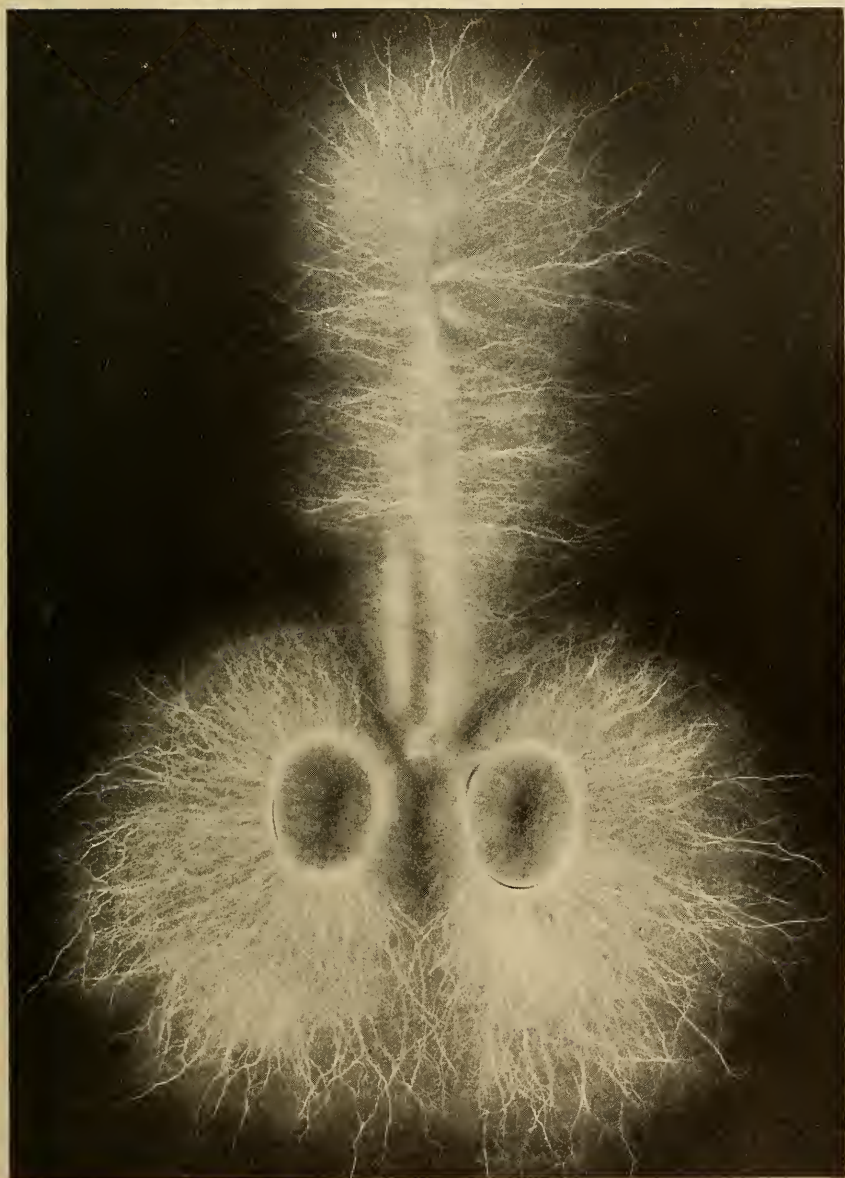

FIG. 103.—Autograph of a Pair of Artery Forceps Laid Upon a Sensitive Plate and Excited for a Fraction of a Second by a Tesla Current Flowing Through a Fine Wire. Made in the Author's Laboratory in 1901.

impinge upon a coil of wire, having the same rate of vibration or some even multiple of that rate, High-frequency Currents will be generated in the latter coil even though it be placed at a considerable distance from the original discharge. Some of the latest systems of wireless telegraphy are based upon the above principle. The resonator of *Oudin* has been already described, and illustrates the manner in which the voltage of a current may be increased by the action of electrical resonance.

CHAPTER XII

THE MEASUREMENT OF HIGH-FREQUENCY CURRENTS

THE majority of physicians who employ High-frequency Currents therapeutically, regard the Hot-wire Milliamperere Meter as an accurate instrument for the measurement of "Dosage." (Fig. 104.) While this is true in the case of the galvanic current, it does not hold good for currents of high frequency and many fallacious deductions have been made by those who assume that the ammeter is an absolute standard of measurement for High-frequency Currents. It is of great value relatively in therapeutic work provided it is always employed in connection with the same apparatus or with currents of similar frequency. In order to understand the inadequacy of the ammeter in the above connection, it is only necessary to remind the reader of the fact that any increase in the frequency of a current causes a corresponding increase in the amperage of the current which it induces in a Secondary *Tesla* Coil or Resonator. (See Chapter 10, Section A.)

No general rule for the determination of the "dosage" of High-frequency Currents can be formulated until we have experimentally determined the exact physiological effect produced by the different frequencies, from the lowest Sinusoidal Current to the highest of the High-frequency Currents which can be obtained from apparatus of the *Tesla-Thomson* type. Up to the present time the majority of the textbooks on electrotherapeutics have stated inferentially, if not didactically, that a given number of milliamperes would produce the same effect whether administered in the form of a *Tesla* or *Oudin-d'Arsonval* Current and irrespective of the frequency of oscillation.

The present writer, however, believes that the amperage is absolutely worthless as a standard of dosage unless taken in connection with the Frequency, Voltage and manner of production of the High-frequency Currents in question.

In the chapter on "Electro-Physiology," the writer has stated his theory regarding the relation of the frequency to the physiological action of oscillatory currents. For the treatment of certain conditions the lower frequencies are most efficient, while for others the highest obtainable frequencies are desirable. In designing his latest types of Therapeutic High-frequency



FIG. 104.—Hot Wire Milliamper Meter for Measuring the Intensity or Volume of Currents of High-frequency.

Apparatus the writer has selected a frequency which, from his twelve years of clinical and experimental research appears to be of the greatest value in the treatment of the pathological conditions which underlie practically all varieties of disease. In other words, the writer has selected a current especially active in restoring depleted vitality, in increasing vital resistance, and in overcoming the circulatory sluggishness which fosters infec-

tion by lowering nutrition and preventing the oxidation of waste products. An extended consideration of this subject will be found in an ensuing chapter.

For convenience and economy an ordinary incandescent lamp may be employed as an indicator of the approximate amperage of a High-frequency Current, the intensity of the illumination being proportional to the volume of electricity. While a hot-wire mil-ammeter should be a part of every complete High-frequency Equipment, the general practitioner, who desires to obtain an electrical outfit at a moderate cost, will find the lamp bulb a fairly efficient substitute for the more expensive meter. A convenient method of using this device is shown in Fig. 105. It is called the Lamp Bulb Electrode and consists of an ordinary

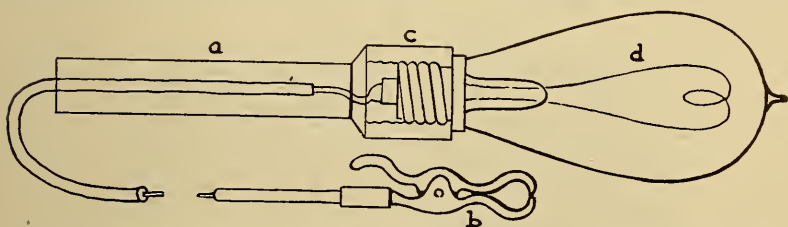

FIG. 105.—Lamp Bulb Hand-Electrode. The Insulated Conducting Cord is Attached to the Tesla Terminal by the Clip (b), and the Current Passes Through the Lamp (d), and Thence to Patient *via* the Metal Handle (a).

keyless lamp socket holding a sixteen-candle power bulb mounted upon a nickel-plated tube which is electrically connected through the socket with one terminal of the lamp. Heavily insulated conducting cord passes through the nickel tube to the other terminal of the lamp socket. The other end of the cord is to be connected to one of the terminals of the *Tesla* Coil, the patient holding the metal tube in place of the hand electrode ordinarily employed. The current from the machine passes through the lamp into the patient's body by way of the metal tube and the amperage of the current is indicated by the degree of light emitted by the filament. If the lamp is fully illuminated, it indicates the passage of about five hundred milliamperes. If the filament is bright red, about two hundred milliamperes is indicated; while a dull cherry red, faintly perceptible except in a dark room, shows the passage of fifty milliamperes.

The writer has constructed a photometric mil-ammeter on the above principle which is fairly accurate. A lamp of the ordinary description attached to a small wooden base is covered with a hood of sheet metal so that no light can escape except through a small aperture in one side of the hood. A disk formed of superimposed sectors of tinted gelatin revolves in front of the aperture, and is so arranged as to gradually shut off the light, the built-up disk being divided into sections of forty-five degrees which gradually increase from a faint tint in the first section to almost complete opacity in the last or eighth section. This

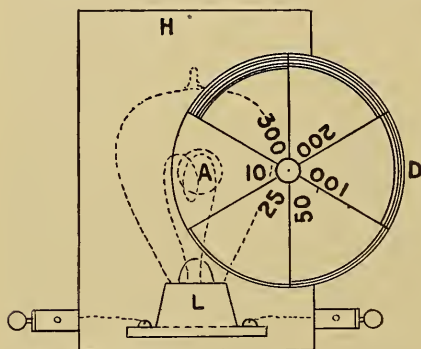

FIG. 106.—The Author's Photometric Mil-ammeter.

L, Lamp Bulb in Opaque Metal Hood (*H*).
D, Disk Formed, or "Built Up" of Colored Gelatin Films, Revolving in Front of the Aperture (*A*).

is, of course, accomplished by cutting away portions of the superimposed films until a graduated series of sections of different thickness is produced. The lamp is placed in series with a hot-wire ammeter between a terminal of the coil and the body of the patient. The gelatin disk is then turned until a section is reached which is sufficiently thin to show the outline of the circular aperture illuminated by the lamp within. The ammeter is then read and the number of milliamperes marked on the face of the sector in front of the aperture with opaque black ink. (Fig. 106.) The current is then reduced until the meter shows just one-half the number of milliamperes in the first reading. The gelatin disk is then turned until the aperture becomes again faintly visible, the sector marked to correspond with the meter and so on until a complete graduation of the gelatin disk is obtained. It is advisable to place the device in a dark box provided with a velvet-edged aperture for the observer, similar to the opening in an ordinary fluoroscope. The gelatin disk, which is, of course, pivoted to the lamp hood may project through a slit in the dark box so as to permit of adjustment from without. The construc-

tion is, of course, accomplished by cutting away portions of the superimposed films until a graduated series of sections of different thickness is produced. The lamp is placed in series with a hot-wire ammeter between a terminal of the coil and the body of the patient. The gelatin disk is then turned until a section is reached which is sufficiently thin to show the outline of the circular aperture

tion of the above device is in reality a much simpler matter than would appear from the description. The tinted gelatin films may be obtained at a small cost from any dealer in projection apparatus. The lamp bulb should be renewed about once in four weeks, otherwise the readings will become incorrect.

There is no practical method by which the physician can measure the frequency of a current from a resonator or *Tesla* Coil. An idea of the relative frequencies of two or more currents may be derived in the following manner. Connect the patient, seated in an ordinary chair, to the terminal of a coil by means of a metal hand electrode; darken the room and gradually approach the patient, holding toward him a medium-sized *Geissler*

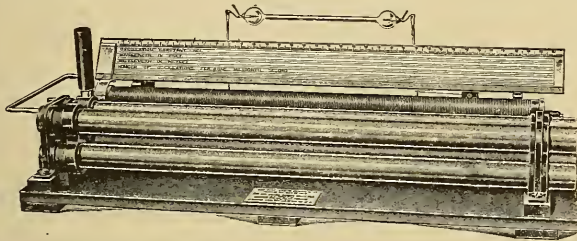

FIG. 107.—Professor Fleming's "Direct-reading Cymometer." (Marconi Wireless Telegraph Co.)

Tube or vacuum electrode; note the distance from the patient at which the tube first begins to glow. Repeat the experiment with the other currents. The current having the highest frequency will cause the *Geissler* Tube to glow at a greater distance from the patient than when the lower frequencies are employed. Of course the current strength should be the same in both cases.

Quite recently *Professor Fleming*, the noted English authority on wireless telegraphy, has perfected an instrument which he calls the "Direct-reading Cymometer," for the measurement of Frequency, Inductance and Capacity. (Fig. 107.) It may also be employed to measure the frequency and wave-length of the Hertzian ether waves employed in wireless telegraphy. The Cymometer consists essentially of a tubular condenser, the capacity of which may be varied by means of its telescopic construction and a coil of bare copper wire, the inductance of which is always kept in

proper relation to the condenser by means of a metal brush which moves with the sliding tubes. The current to be tested is passed through a copper bar in inductive relation to the Cymometer circuit, and the latter is adjusted until absolute resonance is obtained. This point is indicated by the sudden illumination of a *Geissler* Tube containing the rare gas "Neon," the tube being in a shunt circuit with the Cymometer coil. By means of a scale and pointer the frequency may be directly read, and by means of certain mathematical formulæ various other factors of the current may be indirectly calculated.

Unfortunately the range of the instrument is extremely small so that a considerable number of Cymometers with different scales would be necessary for the investigation of the High-frequency Currents employed in therapeutics.

CHAPTER XIII

TECHNIC FOR THE THERAPEUTIC APPLICATION OF HIGH-FREQUENCY CURRENTS

THERE are three distinct types of High-frequency Currents employed in therapeutics at the present time, each of which has its particular field of usefulness and distinctive methods of application. First, the *d'Arsonval* Current which may be derived either from the conventional Solenoid, excited by means of a *Ruhmkorff* Coil or from the primary circuit of a *Tesla* Transformer. Second, the Resonator Discharge which is unipolar and of high potential. Third, the *Tesla-Thomson* High-frequency Current which is of high potential, great smoothness, and is applied by the use of bipolar methods.

(1) *D'Arsonval* Currents.

The technic for the application of solenoid currents may be considered under two headings:

1st. *Direct Application*, in which the current passes from the terminals of the solenoid to two metal or sponge-covered electrodes in contact with the body of the patient.

2d. *Indirect Methods*, in which the patient is connected to one end of the solenoid while the other terminal is connected to an insulated metal plate (auto-condensation), or the patient is surrounded with a large solenoid coil which induces High-frequency Currents in the tissues of the body. (Auto-conduction.)

For the direct application of the *d'Arsonval* Current, two sponge-covered electrodes are employed, wet with salt solution. They should be at least three inches in diameter and are to be firmly applied to the skin on either side of the diseased area. They are to be kept in position during the entire treatment which, as a rule, should not occupy more than fifteen minutes. (Fig. 108.) This is called the "Stabile" method, and is employed in

the treatment of deep-seated local diseases where it is desired to relieve local congestion, break up stasis, and promote tissue combustion and elimination of waste. If more than 500 milliamperes are to be administered, there will be more or less heat and irritation of the surface in contact with the electrode.

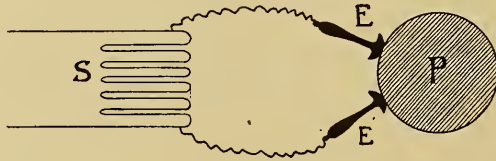

FIG. 108.—Direct Treatment by Current from d'Arsonval Solenoid (S), Applied to Patient, (P), Through Sponge-covered Electrodes (E).

Where it is desirable to use more powerful currents, as, for example, in the treatment of the congestive stage of lobar pneumonia, the so-called "Labile" method should be employed.

In the latter method the patient is connected to one end of the solenoid by a metal hand electrode or by a "Lamp Electrode"

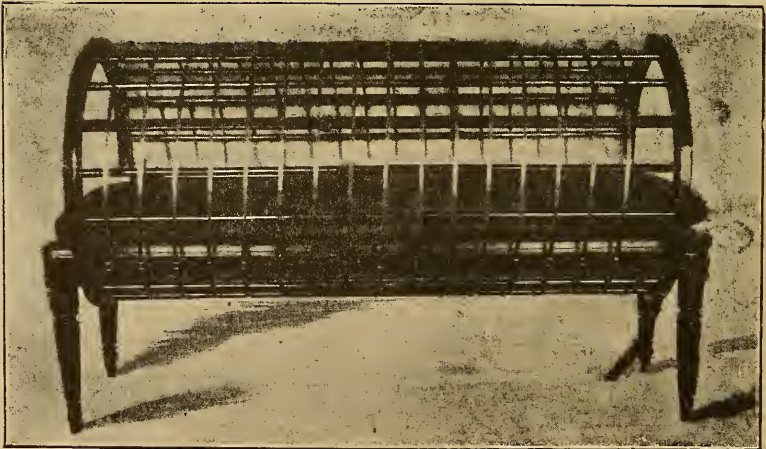

FIG. 109.—Auto-conduction Cage; Horizontal Form.

as described in the last chapter. The other terminal of the solenoid is connected to a large sponge-covered electrode wet with salt solution which is slowly but continuously moved over the affected area for from five to fifteen minutes. In pneumonia, when both lungs are affected, two small sponge-covered elec-

trodes connected to the same terminal may be employed in place of the large pad.

For the treatment of constitutional conditions the *d'Arsonval* Current should be applied by the methods of auto-condensation or auto-conduction. In the latter, the current from the *Leyden*

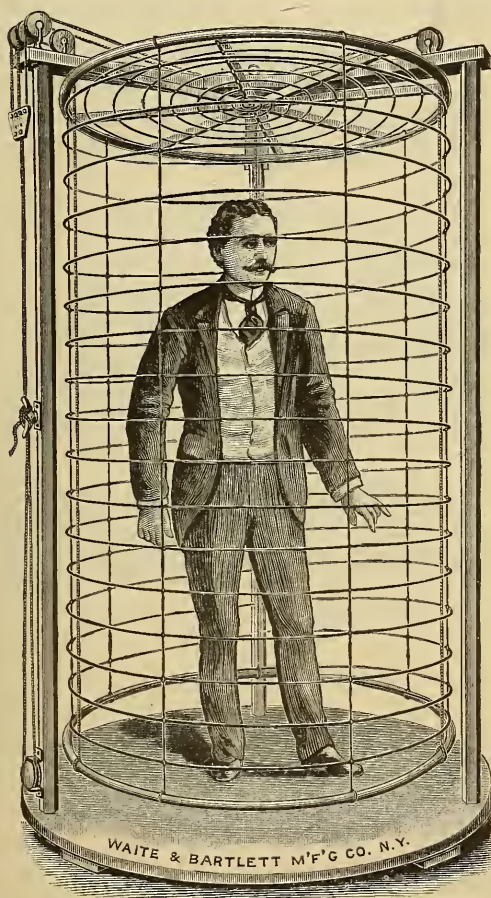

FIG. 110.—Piffard's Improved Auto-Conduction Cage. Vertical Form.

Jars is connected directly to the terminals of a large solenoid in the form of a cage in which the patient stands, sits, or reclines according to the variety of cage which is employed. In the accompanying illustration (Figs. 109 and 110) are shown examples of the horizontal, vertical, and collapsible auto-conduction

cages, while (Fig. 111) shows several smaller varieties for the treatment of the hand, arm or leg. According to the writer's experience, which agrees with that of the best authorities, treat-

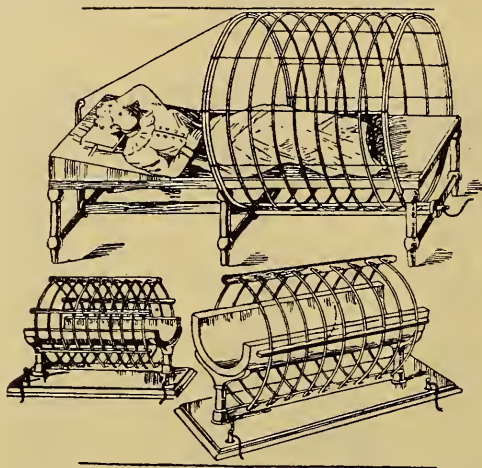

FIG. 111.—Small Cages for Treatment of Arm, Leg, etc.

ment by the method of auto-conduction has absolutely no advantage over auto-condensation, and requires cumbrous and expensive apparatus for which the condenser couch may be satisfactorily substituted.

The principle involved in the treatment by auto-condensation

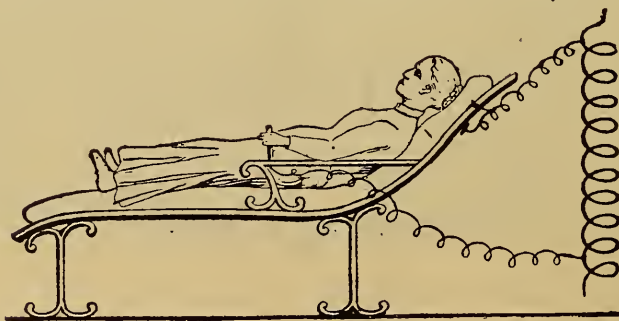

FIG. 112.—Condenser Couch. (Williams.)

has been explained in a previous chapter, with the aid of an hydraulic analogy. (See Fig. 27, Chap. 5.)

The patient is connected to one terminal of the solenoid usually

by two metal hand electrodes which are mounted on the wooden arms of the condenser couch. The latter is an ordinary reclining chair having a thick leather-covered cushion, beneath which is a long plate of sheet zinc which is connected with the other terminal of the solenoid. The High-frequency Currents which would flow into the patient and the plate, even though the two capacities are separately insulated and some distance apart, are much increased in intensity by the mutual induction which takes place across the "Dialectric" formed by the cushion.

A mil-ammeter of the hot-wire type or a sixteen-candle power

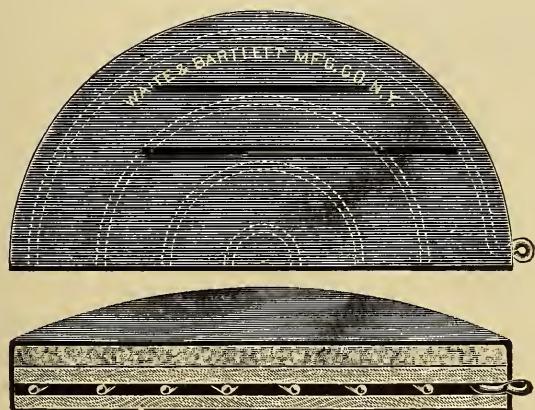

FIG. 113.—Piffard's "Cushion Spiral."

lamp bulb should be placed in series with the patient and the terminal of the solenoid.

The conventional form of condenser couch is shown in Fig. 112. A convenient and inexpensive substitute for the couch is the cushion spiral and condenser chair designed by *Dr. H. G. Piffard*, which is shown in Fig. 113.

It is identical in principle with the couch, except that a flat spiral of heavy copper wire replaces the plate of zinc. The two brass balls shown in the figure are used instead of the conventional hand electrodes. If the physician does not possess a complete resonator equipment, the above chair may be operated by means of the little apparatus shown in Fig. 114. This is also an invention of *Piffard*, and consists of a flat spiral solenoid, in combination with two *Leyden Jars* and an adjustable spark-

gap. It may be used either with a coil or static machine. The treatments by auto-condensation are of value in all diseases involving diminished metabolism, impaired circulation, depleted

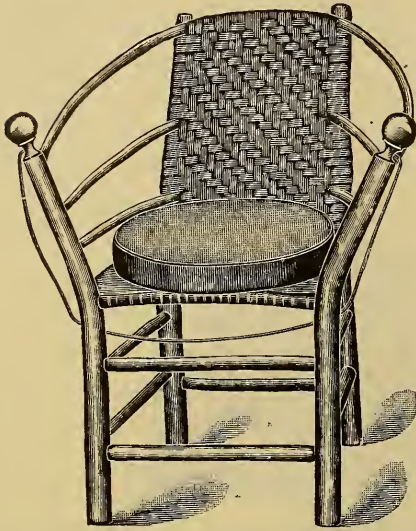

FIG. 114.—Piffard's Condenser Chair.

nervous energy, and the uric acid diathesis. Daily treatments of ten minutes each should be given, as long sittings are apt to cause lassitude.

Several years ago an apparatus of the *Tesla* type was placed upon the market, which contained a flat spiral of heavy wire from which a new variety of High-frequency Current was supposed to be produced. This modality has been quite extensively employed under the name of "Thermo-Faradic." As a matter of fact

it is nothing more or less than a *d'Arsonval* Current of high amperage and the methods devised for its application are identical with those described by *d'Arsonval* for the direct application of solenoid currents.

CHAPTER XIV

THERAPEUTIC TECHNIC (*continued*)

The Resonator Discharge

THE *d'Arsonval* Current is adapted primarily to the treatment of constitutional conditions. The current from an *Oudin* Resonator on the other hand owes its principal value to its local action on diseases of a circumscribed or superficial character. It is essentially monopolar and in the majority of instances is applied directly to the affected area. It may, however, be used indirectly, in which case a complex effect is produced similar to that obtained by the bipolar methods devised by the writer for the application of the *Tesla* Currents. In the present chapter only the direct methods will be discussed. They may be carried out equally well with a current derived from the conventional *Oudin* Resonator, or from a single terminal of a High-frequency Apparatus of the *Tesla-Thomson* type.

The local effects of the resonator discharge result not only from the action of the High-frequency Current itself, which increases the cellular and chemical activity of the superficial tissues, but from the bombardment of the surface of the body by the rapidly moving ions which constitute the spark or effluve discharge, from the action of the ether waves generated by the vibrating electrons, and from the germicidal action of the ozone which is liberated by the electrical vibrations. The exact therapeutic effect of each of these factors is discussed at some length in the Chapter on "Physiology."

Various effects are obtained from the resonator discharge by the use of different types of electrodes, which modify or determine the character of the discharge by their peculiarities of form, material or construction.

The most generally employed and possibly the most important of the "*Resonator Modalities*" is the well-known effluve. Its

physical characteristics have been already considered and its peculiar physiological and therapeutic action will be described in an ensuing chapter. We are concerned at present solely with the technic of its therapeutic application. Recalling the fact that brush discharges are given off by metal points, or edges, while rounded surfaces produce sparks or arcs, it will be evident that the electrodes for the application for the effluve must be of the former character.

A single brass-point electrode, one consisting of a number of points in the same plane, a fan-shaped brush of fine wire, resembling the ordinary "fly killer," and a single point projecting from an insulating glass tube forms an efficient equipment of instruments for the application of the effluve from a resonator. The selection of the particular electrode for the treatment of a given case must be determined by the individual operator from his clinical experience, and his knowledge of electro-physics. A number of types of effluve electrodes are shown in the accompanying illustrations. (Fig. 115.)

The administration of the effluve requires considerable skill and accuracy, inasmuch as a careless motion of the operator's hand, or a sudden and unexpected movement on the part of the patient may bring the electrode too near to the body, and a sharp spark or arc will be produced which, while quite harmless, is often sufficient to inspire a nervous patient with an apprehensive fear of the current which renders future treatment extremely difficult and unpleasant.

The effluve may be applied through the clothing or directly upon the surface. Except for the treatment of diseases of the skin, attended with superficial lesions, the application through the clothing will be found to answer all requirements. For deep-seated conditions a long spark-gap should be employed as it produces a coarse effluve of an extremely penetrating character. For the surface treatment of diseases of the skin, the spark-gap should be as short as possible, the resulting effluve being extremely fine and dense, and attended with a production of large quantities of ozone.

All effluve electrodes should be provided with insulating handles of glass or hard rubber. Many of the electrodes on the

market are provided with handles which are altogether too short, and a portion of the discharge is liable to be diverted to the hand of the operator. The cord by which the electrode is connected to the resonator terminal should be fairly flexible and insulated with soft rubber tubing. It should be attached at either end by a spring clip, a friction plug, screw thread, or some other device by which a firm electrical contact is obtained. It is extremely important that the loose metal hook, swivel or loop,

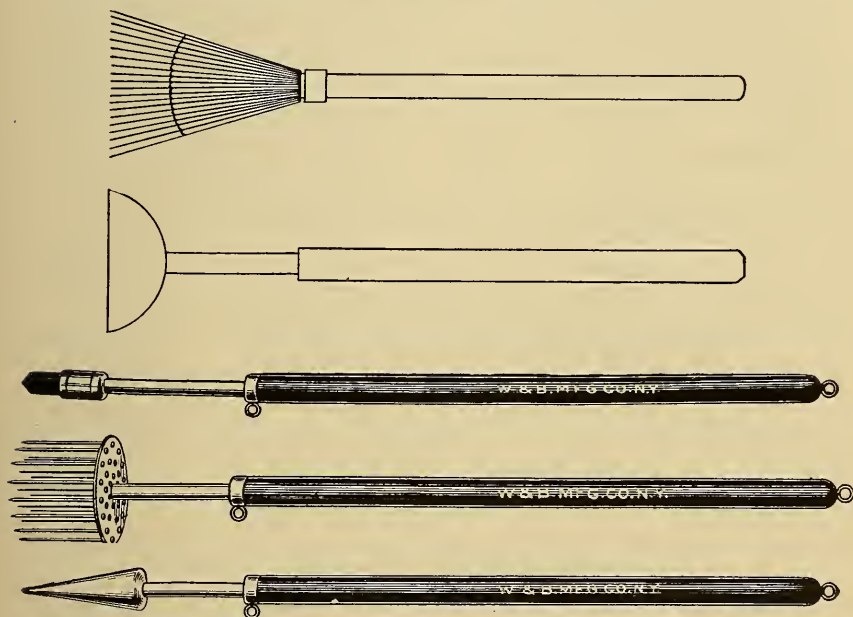

FIG. 115.—Effluve Electrodes; Wire-brush Electrode; Bell Electrode; Carbon-point Electrode; Multiple-point Electrode; Single Brass-point Electrode.

commonly employed for this purpose in many of the electrical outfits now on the market, *should not be used*. The reason for this rule will be stated in connection with the therapeutic technic of *Tesla Currents* where it is of even greater importance than in the case of Resonator currents.

The machine should be started with the electrode at some distance from the patient and it is then brought gradually closer until a full effluve is seen between the metal points, and the patient's body.

By using a metal ball-tipped electrode and opening the spark-gap of the resonator, it is possible to obtain spark discharges not unlike those from a static machine. Unless a long spark-gap is used in the condenser circuit, an arc discharge will be produced from the resonator which would cause a blister on the surface of the body. The arc discharge is sometimes used, however, for cautery purposes in the treatment of small tumors, carbuncles and indolent ulcers. The treatment is carried out as follows: Place the tip of the electrode, connected to the resonator terminal in contact with the surface to be cauterized; make the spark-gap as short as possible and turn on the current. Then carefully

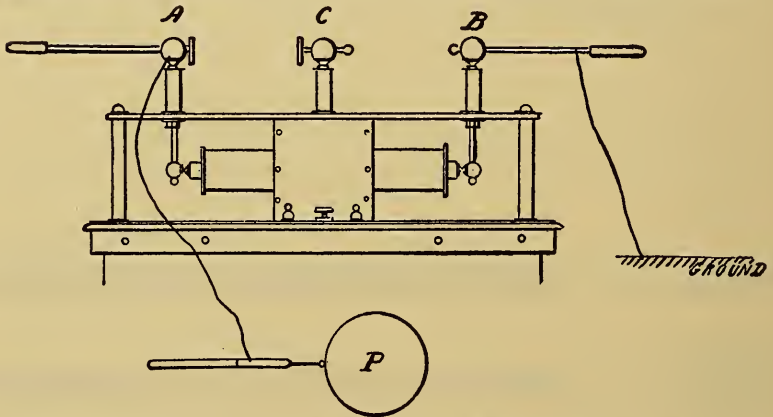

FIG. 116.—“High-frequency Cautery,” Small Metal Ball Electrode in Contact with Patient and Connected to Tesla Terminal.

break contact between the tip of the electrode and the patient and carry the short arc which forms in the air gap, in a circular direction around the edge of the growth until the latter is converted into a white eschar. Care should be taken to prevent the arc from acting upon the normal tissues near the lesion, as blistering and sloughing might otherwise result, attended with unnecessary suffering. The use of a High-frequency Arc for cautery purposes was suggested and employed by the present writer in 1898, using a current from an apparatus of the *Tesla* type. The method was also independently brought out by *Oudin* some three years ago. A further reference will be made to the High-frequency Cautery in connection with the therapeutic technic of the *Tesla* Currents. (Fig. 116.)

The use of vacuum electrodes and glass-covered electrodes in connection with the resonator discharge is familiar to all students of electro therapeutics, and many believe these methods to be a part of the system of technic devised by the inventor of the resonator.

As a matter of fact, however, the principle involving the use of glass electrodes both with and without a vacuum, was originated and developed by the present writer in 1896, whereas vacuum electrodes were not employed or described by the European authorities until the year 1900. The subject is so important from a therapeutic standpoint and involves so much detailed description, that the writer has deemed it wise to devote an entire chapter to its discussion.

In using the *Oudin* Resonator it is necessary to adjust the apparatus so as to produce a condition of electrical resonance between the different parts of the system. This is accomplished by increasing or decreasing the number of turns of the *d'Arsonval* Solenoid; in other words, by varying the inductance. This is done by means of a movable contact which slides over the surface of the solenoid coil. Different methods of "tuning" have been described in the preceding chapter.

CHAPTER XV

THERAPEUTIC TECHNIC (*continued*)

Methods for the Application of Tesla Currents

THE radical difference between the technic and therapeutic action of the resonator discharge and the currents from a *Tesla-Thomson* Coil is due primarily to the fact that the latter are bipolar, whereas the former is monopolar. The following system of technic for the therapeutic application of the *Tesla* Currents was developed by the present writer several years before the High-potential, High-frequency Currents of *Oudin* were brought to the notice of the profession. The writer's methods are usually referred to as the American system of High-frequency Therapeutics in contradistinction to the European technic of *d'Arsonval* and *Oudin*.

The important advantages of the *Tesla* Currents as used by the writer, over those of *Oudin* and *d'Arsonval*, are due to their two-fold effects. They increase the general vitality, promote nutrition, and stimulate circulation, while simultaneously producing all of the local effects of the resonator discharge, but in a more efficient manner. In addition to these purely High-frequency effects, the *Tesla* Currents, when applied in accordance with certain methods devised by the writer, may be used in the treatment of conditions which require interrupted or alternating currents of *low frequency*, for their removal or cure. For example, in the treatment of muscular rheumatism, stiff joints, chronic constipation, and so forth, it would be necessary to supplement treatment by solenoid or resonator currents, with some form of electrical energy capable of producing periodic contractions of the muscles. Ordinarily, a slow faradic, or a sinusoidal current would be employed, or perhaps the static wave current might be used. The writer has devised two distinct methods for the application of the *Tesla* Currents, which produce

deep-seated, intermittent, muscular contractions, yet the characteristic effects of the High-frequency Oscillations are simultaneously produced. A new principle is involved in these methods of treatment, which may ultimately lead to important discoveries when we are more familiar with the specific effects of electrical impulses of particular rates of vibration. The writer has already demonstrated, at least to his own satisfaction, that there is a greater therapeutic effect produced by a High- and Low-frequency Vibration when combined in a single current, than when separately or successively applied.

The composite effect obtained by superimposing a wave of low frequency upon an oscillatory current of great frequency has been called by the writer the Multi-frequency Current. In his early experiments in 1897, he discovered that the interposition of air-gaps or diaphragms of insulating substance in a High-frequency Circuit, formed by connecting the patient to the two terminals of a *Tesla* Coil, disturbed the continuity of the oscillatory stream, producing periodic "breaks," or fluctuations in the amplitude of the alternating impulses, and that these interruptions produced the same physiological effects that would result from the application of a faradic or interrupted galvanic current of the same periodicity. It was this discovery which led the writer to experiment with sheets of glass, and later with hollow glass electrodes containing either a conducting substance or a "Low Vacuum" in studying the therapeutic effects of the *Tesla* Current. During the past few years, a number of interesting devices for impressing simple or complex waves of lower frequency upon the rapidly oscillating *Tesla* Current have been constructed in the writer's laboratory, but inasmuch as there is no satisfactory method of analyzing or graphically recording the modalities thus produced, and as insufficient clinical evidence has been obtained up to the present time to permit of their practical differentiation from a therapeutic standpoint, it has been deemed advisable to give no detailed account of these experimental methods until experience has taught us more regarding their individual importance in Electro-Therapeutics.

For general High-frequency Effects the *Tesla* Currents may be employed with a condenser couch or a *Piffard* Chair in the

same manner as the *d'Arsonval* Current. The therapeutic effect differs from that of the solenoid currents, producing less intense stimulation of the tissue metabolism, and combustion, and increasing to a greater degree the action of the vaso-motor system, and general trophic influence. The vacuum condenser chair may be substituted for the couch with a decided gain in therapeutic action. It will be more fully described in the Chapter on "Vacuum-Electrodes."

The effluve from a *Tesla* Coil produces the same local effects as the resonator effluve, but the action extends to the more

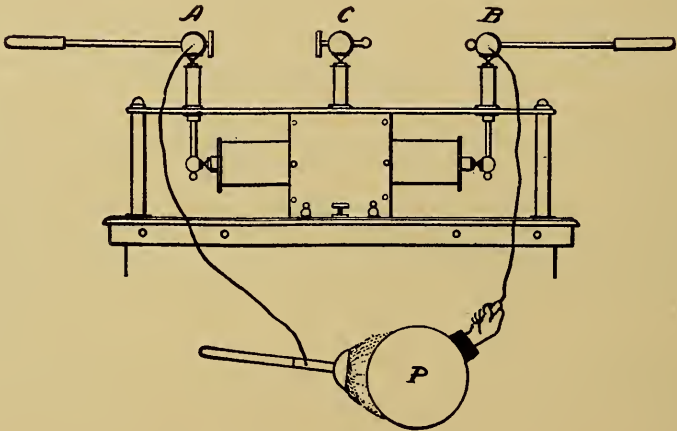

FIG. 117.—Tesla-Effluve.

deep-seated tissues and involves an intense stimulation of the entire circulatory system which is of great value in relieving the fever and congestion in the initial stages of acute infectious disease. This latter effect is due to the incidental formation of waves of low frequency and the above method of treatment may therefore be classed with the writer's Multi-frequency Modalities. (Fig. 117.)

It should be distinctly understood that when reference is made to a "Resonator Effluve," the writer means the direct, monopolar treatment, with a current of high frequency and high potential, whether the current be derived from an *Oudin* Resonator or from a *single terminal* of a *Tesla* Apparatus. The terms "*Tesla* Treatment," "*Tesla* Effluve," etc., are employed

solely in connection with the bipolar methods devised by the writer, in which the patient forms a part of the circuit connecting the *two poles* of a *Tesla* Apparatus. The effect of the *Tesla* Effluve may be modified by connecting the opposite pole of the apparatus to a flat metal electrode placed over the spine or solar plexus, or by the use of an ordinary hand electrode in place of the condenser couch. For the treatment of nervous dyspepsia attended with constipation, the flat block-tin electrode connected to a *Tesla* Terminal should be placed in contact with the skin over the solar plexus, and the effluve applied up and down the spine by means of a metal point or brush electrode connected with the other pole of the *Tesla* Coil. This is an extremely

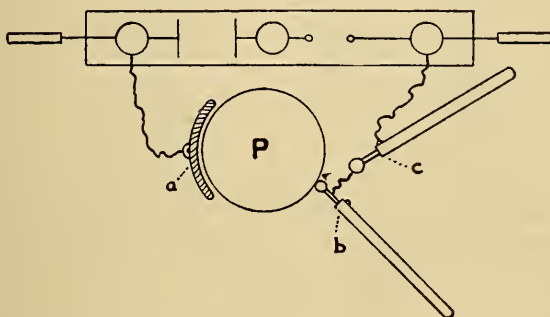

FIG. 118.—“Pseudo-static Spark” Treatment.

a, Block-tin Electrode. *b*, Metal ball in contact of Patient. *c*, Metal Ball Electrode Connected to *Tesla* Terminal.

valuable modality, and will be frequently referred to in the chapters on “Special Therapeutics.”

The use of the “Pseudo-Static Spark” from a *Tesla* Coil is of value in the treatment of partial paralysis, muscular rheumatism and deep-seated neuralgic pain. It is administered by the same technic above described for the *Tesla* Effluve, the only difference being that a small carbon point or ball-tipped electrode should be substituted for the brush or metal point, and the spark-gap opened as widely as possible. Care should be taken in approaching the patient with the electrode as an arc will be formed if it is brought too near to the surface. (Fig. 118.) The effects of the spark are similar to those produced by the static wave current, except that there is added the general vitalizing action of

the High-frequency Oscillations. Applied over motor points, the *Tesla Spark* produces powerful muscular contractions, less painful than those resulting from the spark of a static machine. The danger and unpleasantness of a surface burn from an accidental arc is avoided by holding an insulated metal ball electrode in contact with the skin of the affected area and allowing the sparks to occur between this electrode and the active electrode connected with the *Tesla Coil*. This "Indirect *Tesla Spark*" is of special value when used over the motor points in cases of partial paralysis.

A general treatment somewhat resembling the "Indirect Spark" in the manner of its production, is a modality which the writer has

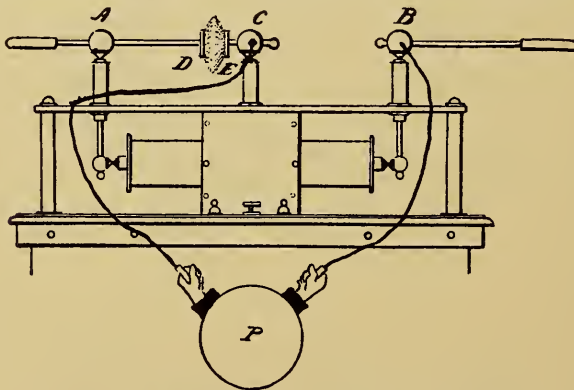

FIG. 119.—High-frequency "Motor-Wave Current."

termed the "High-frequency Motor Wave Current." (Fig. 119.) For the production of this current, the writer's Triple Terminals are necessary. The patient is connected to two metal plates or hand electrodes, one of which is attached to Terminal *B*, the other to the "Dummy" Terminal *C*. The apparatus is started with the disks and small balls separated as widely as possible, a medium spark-gap being usually employed. The sliding rod in Terminal *A* is gradually pushed in until an even purple effluve is formed between the disks. At this point the patient will experience a sensation similar to that of a Faradic Current except that the impulses are irregular rather than strictly periodic. Patients familiar with Faradic Coils, when experiencing this current for the first time, often complain of its lack of

smoothness and inquire "whether the vibrator does not require adjustment." As a matter of fact it is probable that the great value of this modality as a general stimulant and invigorator is due, to a great extent, to the complex mixture of vibrations of different frequencies by which the supposed irregularity is produced. The action of this current will be discussed more fully in the Chapter on "Physiology."

A Low-frequency Effect, approximating that of the sinusoidal current, may be obtained by a mechanical modification of the modality just described. The apparatus for its production consists of a fixed strip of brass, edged with saw-teeth and a revolving disk of thin copper mounted eccentri-

cally in the same plane as the fixed strip. The disk is mounted on an insulated shaft terminating in a brass ball, separated by a minute air-gap from a stationary ball mounted upon an insulating support. By means of an adjustable clockwork or a small electric motor provided with a rheostat for regulating its speed—the eccentric disk is made to revolve at any desired rapidity, thus periodically

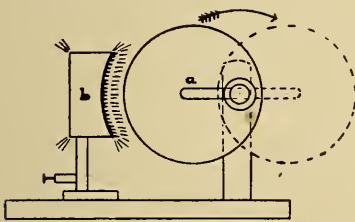

FIG. 120.—The Author's Mechanism for Superimposing a Low Frequency, Sinusoidal Wave Upon a Tesla Current.

- a, Revolving Metal Disk Mounted Eccentrically, with Slot for Changing the Degree of Eccentricity.
- b, Upright Metal Plate with Serrated Edge, which can be Moved toward the Revolving Disk and Fixed in Any Position Upon the Base, c.

and gradually lengthening and shortening the distance between its periphery and the serrated edge of the fixed plate. The latter is mounted upon an insulating support which slides between parallel grooves, permitting the distance between the disk and plate to be varied to any desired degree. (See Fig. 120.) At the beginning of the treatment the sliding plate is withdrawn as far from the disk as possible; the plate is connected to Terminal A of the Tesla Coil, and the stationary brass ball to a metal electrode in contact with the body of the patient, the circuit being completed by a second metal electrode connected to the Tesla Terminal B. The clockwork, or motor is started, the current turned on, and the serrated plate is slowly pushed toward

the disk until a fine purple effluve is observed in the intervening air-gap at the part of each revolution, in which the disk edge is nearest to the serrated plate. The result will be a periodic wave current, producing painless, intermittent, muscular contractions, similar to those obtained from a sinusoidal current of low frequency.

Another variety of Multi-frequency Current is produced by connecting two metal electrodes in contact with the patient respectively to the Terminal *A* and to the "Dummy" *C*. The treatment is begun with the disks widely separated and the small balls in contact, the latter are then carefully separated by withdrawing the sliding rod in Terminal *B* until a gap of from one to

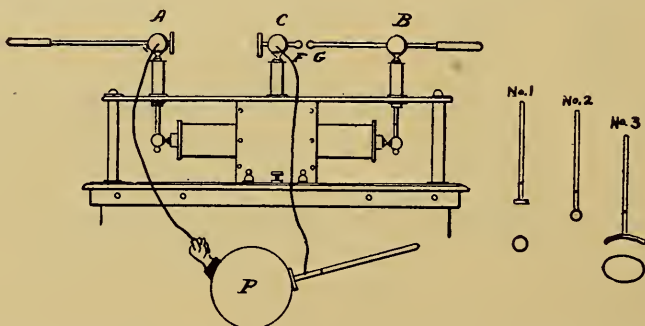

FIG. 121.—High-frequency Motor-impulse Current. ("Pseudo-faradic.")

five millimeters is formed. The rapid succession of muscular contractions produced in the patient by this procedure is so intense that a distance of two millimeters is as great a separation of the balls as will be practical with the majority of cases. The probable explanation of the lack of sensation attending the direct passage of the *Tesla* Current through the body of a patient as compared with the intense motor and sensory effects resulting from the interposition of a spark-gap in the above circuit, lies in the peculiar nature of the arc which flows across the air space. (Fig. 121.) The intense heat which this discharge produces causes an upward current of air which carries the arc with it, increasing the curvature of the latter until it finally breaks, to instantly re-form in its original position. Each "Break" of the arc causes a sudden rise in the potential of the patient's body,

which as suddenly drops almost to the *zero* point simultaneously with the re-forming of the arc. (Fig. 123.)

This method of treatment is primarily a motor stimulant, and may be employed for the same purposes as the faradic or interrupted galvanic current. The potential of the oscillations is

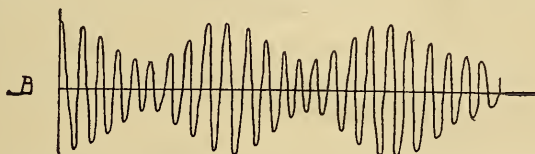

FIG. 122.—Theoretical Tracing of Current Obtained by the Use of the Author's Mechanical Device, shown in Fig. 120.

rather low, except at the moment following the break of the arc. The writer has devised a variety of mechanical interrupters for the purpose of converting the above-described modality into a motor current of smooth and even character, the interruptions of which may be made to occur at any desired frequency. They

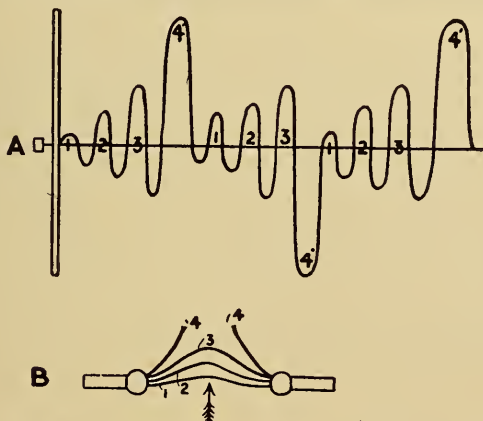

FIG. 123.—A, Theoretical Tracing of "Pseudo-faradic" Current. B, Periodical Elongation and Breaking of Tesla Arc by the Upward Current of Hot Air. (Numbers in the "arcs" correspond to those in the tracing.)

are simply mentioned in passing, as the work is still in the experimental stage.

There is still another method by which simple or compound vibrations of low or moderate frequency may be superimposed upon the oscillatory current of a *Tesla* Coil. It consists in the

periodic modification of the resistance of the spark-gap in the condenser circuit, which may be accomplished by the vibration of one of the terminals of the gap, by rotating a slotted disk of mica in the path of the discharge, or by causing an intermittent pencil of some form of radiant energy to periodically ionize the air in the gap between the terminals. The writer has in this way been able to impress sound waves upon the High-frequency Current and has even produced a musical or speaking "Arc" in the secondary *Tesla* Circuit. As a carrier of vibration it is possible that the *Tesla* Current may ultimately be employed through the development of the writer's methods as a means of conveying sensory impressions to the nerve centers when the normal path has been destroyed by accident or disease. The High-frequency Current readily traverses the tissues of the body, the nerves being especially good conductors of electrical oscillations; consequently in a case, for example, where the conducting mechanism of the external and middle ear has been destroyed and rendered functionless, sound waves might still be transmitted to the terminals of the auditory nerve by means of a High-frequency Current, the oscillations of which have been modified by the superimposition of the audible vibrations. The perfection of this method may lead to the successful solution of the problem of enabling a *totally deaf person to hear*.

The writer believes that he is the first to suggest the use of High-frequency Currents as carriers of vibration, and is confident that his discovery will lead to important developments, not only in electro-therapeutics, but in the application of High-frequency Currents for technical and commercial purposes.

CHAPTER XVI

THERAPEUTIC TECHNIC (*continued*)

Treatment by Means of Glass "Vacuum Electrodes"

IF the general employment of a new device by members of the medical profession may be taken as evidence of its practical value, the Vacuum Electrode may be justly regarded as *the most important* contribution to Electro-therapeutic Technic since the advent of the High-frequency Current. When first devised and employed by the writer in 1896, it was ridiculed as a spectacular toy by a number of physicians, many of whom now use it in their daily practice. At the present time it is almost universally employed for the administration of High-potential Currents of both the Static and High-frequency types.

The use of hollow glass electrodes exhausted to a so-called "Low Vacuum" for the administration of High-frequency Currents originated through certain clinical experiments conducted by the writer in the laboratory of *Dr. J. P. Sutherland*, who is at the present time Dean of the Boston University School of Medicine. In investigating the possibilities of the X-Ray as an aid to vision in the partially blind, the writer had connected the subject to one pole of his original *Tesla* Apparatus by means of a metal electrode, and was trying the effect of bringing an X-Ray tube with its anode connected to the ground, in contact with the eyeballs and forehead of the subject. Flashes of light were seen or sensed at the moment of contact, and in order to determine whether this effect was due to the X-Ray, or to the High-frequency Discharge, the experiment was repeated using a *Geissler* Tube grounded through the body of the operator, in place of the *X-Ray tube*. The flashes of light were not produced, but a peculiarly pleasant sensation experienced by the patient led to the continued application of the tube for perhaps five minutes. At the expiration of this interval the subject of the experiment

suddenly announced that an intense neuralgic headache with which he was suffering when he came to the laboratory, had entirely ceased. He also stated that these headaches usually lasted from twenty-four to forty-eight hours, and that up to that time he had been absolutely unable to obtain relief, although he had tried all of the conventional methods of treatment. The writer subsequently treated this patient on several occasions and discovered that the use of the *Geissler Tube* as an electrode invariably relieved the headache, usually within ten minutes after beginning the treatment.

It was nearly a year after this experiment before the writer was able to have constructed a series of Vacuum Electrodes

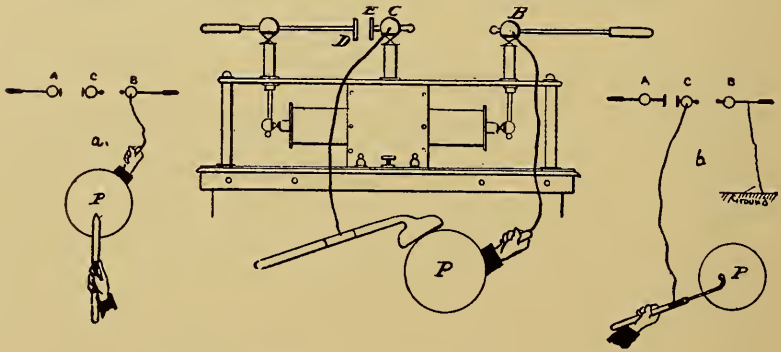

FIG. 124.—The Author's Technic for Vacuum Electrodes. "Tesla Vacuum Treatment."

a, Indirect Mono-polar Treatment. *b*, Direct Mono-polar Treatment.

adapted to the treatment of different parts of the body. During this interval, however, he had fully demonstrated the value of the Vacuum Electrode by successfully treating a variety of cases with High-frequency Currents by means of an improvised electrode, consisting of a plain *Geissler Tube* with its upper terminal covered with sealing wax, and its opposite end fixed in an insulating handle. Having already invented his triple terminals, the writer administered the treatment as follows: With the disks and balls widely separated, the patient was connected with Terminal *B* by a metal electrode; the *Geissler Tube* Electrode was connected by a cord to the Dummy *C* (see Fig. 124). The end of the electrode was applied to the affected area, and the

current turned on. The intensity of the local effect produced by the Vacuum Electrode was increased by pushing in the disk on the sliding rod in Terminal *A*, in other words by lowering the resistance of the air-gap between the disks. The latter were not permitted to be sufficiently close to allow of the formation of an arc between them. This Bipolar Vacuum Treatment produces both constitutional and local effects, the latter being due not only to the High-frequency Current but to the secondary vibrations of the electrical and radiant energy generated by the passage of the current through the partial vacuum of the tube. These effects will be described in detail in the Chapters on "Electro-Physiology."

The phenomena of electrical conduction in partial vacua may be experimentally studied by exhausting the air from a glass tube about twelve inches in length, provided with terminals connected to the poles of a small static machine or coil, capable of producing a spark of from two to six inches in length. A good mercury pump or compound oil pump of the "*Geryk*" type, will be required for this experiment. At the pressure of the atmosphere, no current will pass through the tube, the distance between its terminals being double the length of the maximum spark from the coil. If the pump be now slowly operated until four-fifths of the air in the tube have been removed leaving a pressure of one-fifth of an atmosphere between the tube terminals, a faint branching brush discharge of violet color will appear in the tube. Evidently the withdrawal of air has increased the conductivity by diminishing the resistance of the tube. Again operate the pump until about one-twentieth of the original air is left. The current will now flow between the terminals in the form of a thin red line or thread. If the finger of the operator be brought near the tube, the luminous thread will be brought toward it exactly as the center of an elastic steel wire would be drawn to a powerful magnet. Now carry the exhaustion to one-fiftieth of an atmosphere and the thread of light will expand into a luminous pencil or band, while a violet aura will be seen surrounding both terminals in the tube, especially the cathode. Carry the exhaustion still further, until all but one five-hundredth of the original air has been removed

from the tube. The diameter of the luminous pencil will increase until it fills the entire tube. A number of transverse striations will be seen dividing the discharge into series of disks of light of equal thickness. The violet aura at the cathode has become more distinct and a dark space separates it from the series of disks on one hand, and from the surface of the cathode on the other. As the exhaustion proceeds from one five-hundredth to one ten-thousandth of an atmosphere, the disks become thicker and the striations fewer, and the color changes from a rose-pink to violet, blue, blue-white and finally to a dense yellowish-white. The violet aura at the anode has shrunk to a mere point, while that which surrounds the cathode has grown larger and the dark space wider. Inside this dark space the metal cathode glows as if it were red hot. From this point the further exhaustion of the tube is accomplished slowly and with great difficulty. After a considerable interval the pressure in the tube will be diminished to one fifty-thousandth of an atmosphere, and the light in the tube will have entirely ceased except for an irregular white cloud which flutters in the center. The walls of the tube, however, have become luminous with a brilliant apple-green fluorescence, and if a screen coated with barium platinum cyanide be held near the tube with a sheet of paper intervening, an area of light will appear on the screen due to the X-Rays produced by the intensely vibrating electrons in the tube. With a good pump it is possible to carry the exhaustion still further until all but one-millionth of original air has been removed from the tube.

The current now meets with considerable resistance and will "back up" a spark of three or four inches in length across an adjustable air-gap parallel with the tube. The resistance of the tube is at its minimum at a pressure of one ten-thousandth of an atmosphere when not more than one-fourth inch of spark can be obtained at the parallel gap. With the final exhaustion at one-millionth, etc., there is no light whatever in the tube and only the intense fluorescence of the glass indicates the passage of the current. The X-Rays from the tube are now of greater power, penetration, and shorter wave length than in the preceding stage. By special methods it has been found possible to obtain a still higher degree of exhaustion, and tubes have

actually been made with internal electrodes only one millimeter apart, which would nevertheless resist a voltage capable of producing a spark several feet in length. A perfect vacuum is therefore theoretically an absolute non-conductor of electricity.

If the above experiment be performed with a *Tesla* High-frequency Current, instead of a *Ruhmkorff* or Static Current, practically the same phenomena will be produced, except that no "transverse striations" will appear, and the purple aura will present the same appearance and brilliancy at both of the internal terminals. These differences are, of course, due to the fact that the current in the tube is oscillatory rather than unidirectional.

If a tube containing fluorescent minerals such as willemite, calcite, kunzite, etc., be connected to a *Tesla* Coil and exhausted by means of an air pump, the minerals will emit light of different colors as soon as the pressure is reduced below one five-hundredth of an atmosphere. The effect is due to the production in the tube of ether waves beyond the limits of vision, which are generally spoken of as "Ultra-violet Rays." These rays would be of value therapeutically were they not prevented from reaching the surface of the body by the opacity of the glass walls of the tube. Some years ago the writer devised a vacuum electrode capable of transmitting these ultra-violet rays, through a quartz lens cemented to one end of the tube. (See Chapter on "Ultra-violet Rays.")

Several years after the writer's discovery of the Vacuum Electrode, instruments of this kind were placed on the market by a New York firm. They were sold in sets including different shapes and sizes, and but little attention was given to the degree of exhaustion employed. In consequence some of the electrodes were of the "white," and some of the "Red Vacuum" type, varying in exhaustion from one-fiftieth to one ten-thousandth of an atmosphere. The disparity in the results obtained in similar cases treated by different electrodes led the writer to begin a series of experiments for the determination of the relation between the degree of exhaustion and the therapeutic effect. A description of the details and results of these experiments is given under the head of "Electro-Physiology." For the present

it will suffice to say that the effects of Red Vacuum Electrodes were found to be quite different from those of higher exhaustion, and that since the date of the above experiments all commercial vacuum electrodes have been made to conform to a standard "Low Red Vacuum."

At the present time there are many forms and varieties of Vacuum Electrodes on the market, some of which are shown in

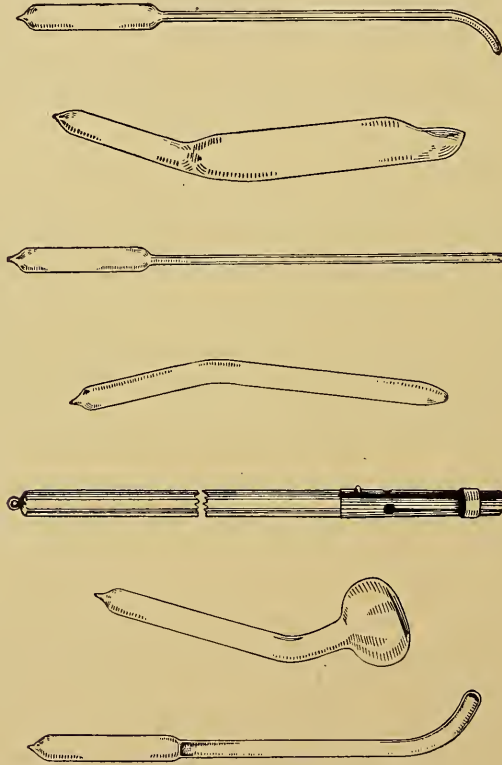

FIG. 125.—Doctor Snow's set of Vacuum Electrodes.

the accompanying illustrations. Among other ingenious improvements which have been made since the original introduction of the Vacuum Electrodes, mention may be made of the Insulating Air-jacket, for the purpose of preventing the escape of the current except at the extreme ends of the electrodes, for the treatment of internal conditions. Electrodes of this type are formed of two concentric tubes, the inner one being the real

vacuum tube, which is prevented from discharging into the body by the annular air space surrounded by the outer tube. Several varieties of these double-walled electrodes are shown in Fig. 126.

For increasing the intensity of the local effect produced by High-frequency Currents, a "Condenser Electrode" may be employed, instead of the simple Low-vacuum Electrode. The latter are usually supplied without internal electrodes, receiving the current from the brass socket at the end of an insulating handle which is made to be used interchangeably with the different electrodes in the set. (See Fig. 125.) Condenser electrodes on the other hand are provided with an internal terminal

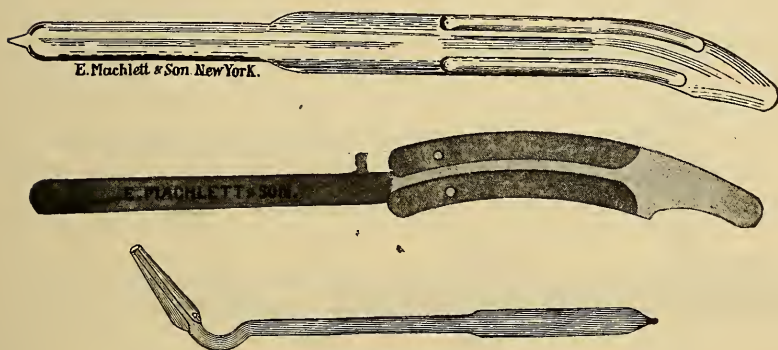

FIG. 126.—Double-walled Vacuum Electrodes.

in the form of an aluminum rod, or disk. The space between the terminal and the inner walls of the tube may contain air at the ordinary pressure, salt solution and the other fluids, or may be exhausted to a low or high vacuum.

Condenser electrodes were first employed by the present writer several weeks prior to his invention of the vacuum electrode. The fluctuations of the spark-gap in his original apparatus rendered the effluve from the *Tesla* Coil so irregular that great difficulty was experienced in the use of the latter modality without "sparking" the patient. Having already noticed the ease with which the *Tesla* Currents passed through glass and other non-conductors, the writer experimented with a sheet of thin plate glass applied to the body of the patient as a protection against "sparking" during effluve treatment. Although this

method did not prove a satisfactory substitute for the Direct Effluve Treatment, it led to the development of a new modality which is at present applied by means of the so-called "Condenser Electrode." As originally employed, the patient was connected

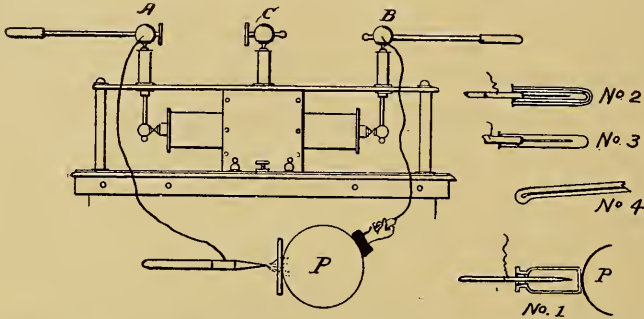

FIG. 127.—The Author's Technic for the Use of Glass Condenser Electrodes.

to a *Tesla* Terminal by means of a metal hand electrode and a metal point connected to the opposite terminal was applied to the outer surface of a plate of glass in contact with the upper epigastrium, a beautiful "rosette of sparks" radiated from the

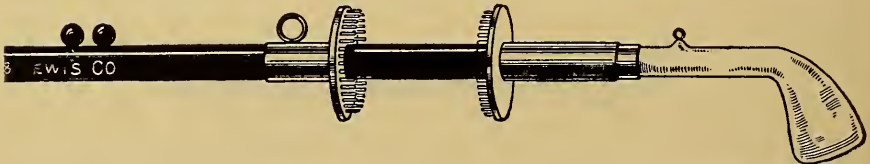

FIG. 128.—The Author's Regulating Handle for Vacuum or Condenser Electrodes.

point over the glass surface, and slight Faradic effects were produced in the region near each electrode. A rather unpleasant noise is produced by the discharge, but despite this fact, the writer still employs the original technic in the treatment of



FIG. 129.—Herschell's Regulating Handle and Rectal Electrode. (Williams.)

nervous dyspepsia, and other conditions involving a depletion or lack of power in the sympathetic nervous system. The first condenser electrodes constructed by the writer consisted of metal rods fixed in insulating handles, surrounded by glass

tubes, the extremities of which were flat, rounded or bulb-shaped, adapted to different parts of the body. (See Diagram Fig. 127.) Later the metal rod was made to slide into the insulated handle, so that its free end could be pushed into actual contact with the sealed end of the glass tube or withdrawn to a distance of several inches. This construction permits the regulation of the strength of the discharge which may be varied from a slight warmth, to a stream of sparks capable of blistering the surface. The writer has in his possession his original electrode of this type, and still occasionally employs it in his practice.

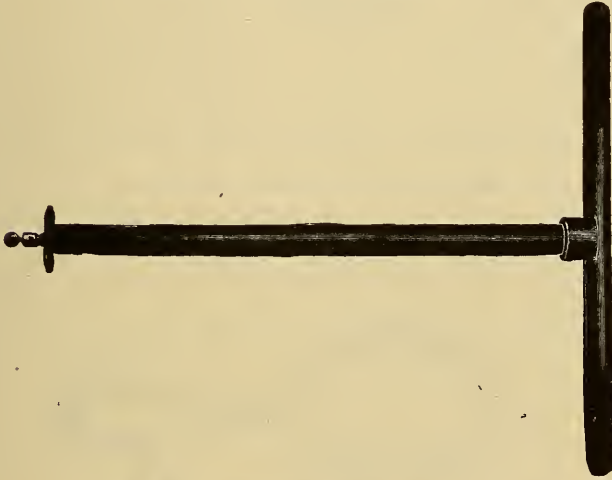

FIG. 130.—Ebonite Spinal Electrode. (Williams.)

The above method of regulation suggested to the writer the idea for his regulating handle for vacuum or condenser electrodes. It is practically an application of the principle embodied in the writer's Triple Terminals, in which the effluve between metal disks forms a rheostat for the regulation of the current strength.

An interesting fact in connection with the writer's regulating handle which is shown in Fig. 128, is the independent invention of a similar device by *Doctor Herschell* of London, for use in connection with his Rectal Electrode, which was described by its inventor in his manual of "Intragastric Technic." (See Fig. 129.)

A large variety of condenser electrodes have been devised and

introduced by different authorities, some of glass filled with liquid, or granular carbon, others of ebonite vulcanized over metal rods of various shapes and sizes. (Fig. 130.)

From a physical standpoint, all vacuum electrodes are con-

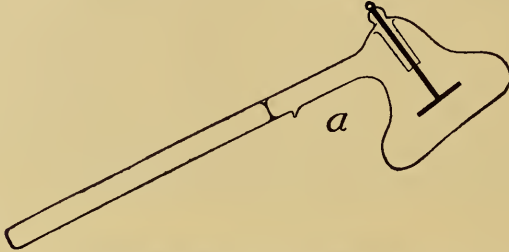

FIG. 131.—Condenser Electrode; “Low Red Vacuum Type.”

denser electrodes, but custom has limited the latter term to vacuum electrodes of a special construction involving the use of an internal disk-shaped aluminum terminal. The conventional condenser vacuum electrode is represented in Fig. 131. Another modification is shown in Fig. 132.

The same technic is employed in the therapeutic application

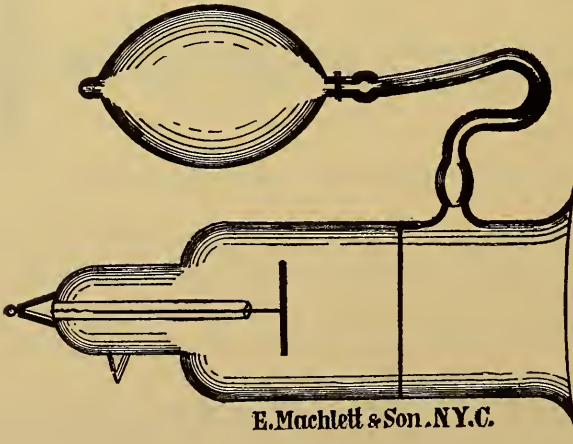

FIG. 132.—Vacuum Condenser Electrode with Cupping Device.

of *all varieties* of condenser electrodes. This technic includes several different methods namely:

- (A) Monopolar Direct Application.
- (B) Monopolar Indirect Application.

(C) Bipolar Direct Application.

(D) Bipolar Multi-frequency Treatment.

(A) *Monopolar Direct Application.*—This is the simplest method for the direct application of High-frequency Currents

from a resonator or from a single pole of a *Tesla Coil*. The action is local rather than general but the effects are intense, and it is seldom necessary to apply the electrode for more than ten minutes at a time. The electrode fixed in an insulating handle is connected to the terminal of the coil

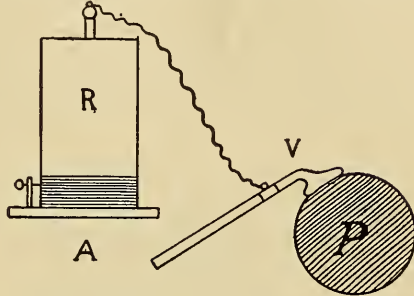

FIG. 133.—Monopolar Direct Technic.

by a rubber-covered conducting cord, and applied to the affected surface before turning on the current. But little sensation other than warmth is produced when the electrode is applied to the skin, but if one or more layers of clothing intervenes, a stinging, tingling feeling is experienced by the patient which increases in intensity as the clothing increases in thickness. (Fig. 133.)

Skin lesions and superficial conditions usually require the *direct application* of the glass surface of the electrode. Diseases involving the deeper tissues, such as cellulitis, neuralgia and

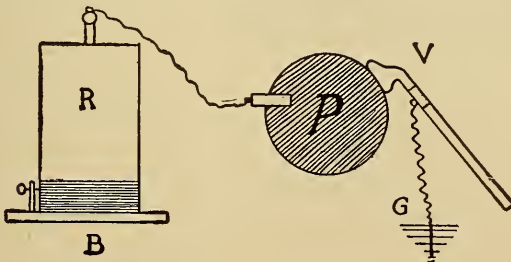

FIG. 134.—Monopolar Indirect Technic.

rheumatism are more readily relieved by applying the electrode over the clothing or by covering the end of the electrode with cloth of any desired thickness; woolen fabrics being best suited to this purpose. The differences in the physiological effects

produced by these varieties in technic are discussed in detail in an ensuing chapter.

(B) In the *Monopolar Indirect Method*, the patient is connected to the resonator or *Tesla Terminal* by a metal plate or hand electrode and the vacuum or condenser electrode connected to the ground or held in the hand of the operator, is applied to the affected area. By this method a mild general effect is added to the local action of the electrode discharge, and the action of the latter is somewhat less intense than in the method previously described. The glass electrode is applied to the surface or through clothing as in the preceding description. (Fig. 134.)

(C) *Bipolar Direct Application* involves the use of two vacuum electrodes, each of which is connected to a terminal of the *Tesla Apparatus*, or, one electrode may be attached to the terminal of

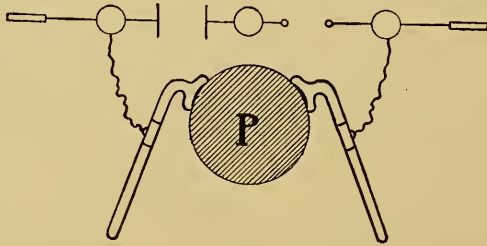

FIG. 135.—Bipolar Direct Application of Vacuum Electrodes.

a resonator, the second electrode being connected with the ground. The first method should be used if possible, as its effects are much more intense. As a rule the electrodes must be applied directly to the surface of the body, as blistering may result if the clothing intervenes. One exception to this rule may be made in the application of currents of low amperage and very high voltage and frequency, such as are produced, for example, from the *Piffard Hyperstatic Transformer*. The writer has found the bipolar method of especial value in the treatment of pulmonary tuberculosis and lobar pneumonia. (Fig. 135.)

A variation of the Bipolar Technic is exemplified in the use of the vacuum condenser chair recently introduced by *R. Friedländer* of Chicago. This device in addition to its spectacular and impressive appearance possesses real merit from a therapeutic standpoint, and the writer has obtained excellent results from

its use in the treatment of functional and organic diseases of the nervous system. In the majority of these cases the patient is seated in the chair which is connected to one of the *Tesla* Terminals, and a vacuum condenser electrode connected to the other terminal, is applied over the solar plexus. The efficiency of the treatment is increased if the clothing be removed from the upper half of the patient's body. Insomnia or nervousness resulting from prolonged mental or physical exertion is almost invariably relieved by a High-frequency Bath by means of the vacuum chair. The latter is connected to a *Tesla* or resonator terminal as described in Section A, and the patient seats himself in a comfortable position and voluntarily relaxes every muscle of the body, closes the eyes and rests during a treatment of from ten to twenty minutes duration. By this method the accumulated waste products resulting from a long day's work are removed from the muscles and superficial tissues and at the termination of the treatment the patient will be almost as rested and



FIG. 136.—Friedländer's Vacuum Condenser Chair.

invigorated as from a night of refreshing sleep. In the opinion of the writer the vacuum condenser chair is a valuable if not an essential addition to the equipment of every progressive electrotherapist. (Fig. 136.)

(D) *Bipolar Multi-frequency Treatment* involves a combination of the writer's Multi-frequency Treatment with the vacuum or condenser electrode. A *Tesla* Apparatus provided with the writer's Triple Terminals being required for the production of this modality. One of the *Tesla* Terminals *B* is connected to a metal electrode in contact with the patient's body, a vacuum

electrode is connected with the "Dummy," and the current strength regulated by the length of the effluve between the two metal disks. This technic, which has already been described in a previous paragraph, produces the characteristic local effects of the vacuum electrode, the general effects of the *Tesla* Current, and an additional "Multi-frequency" effect on the motor nerves

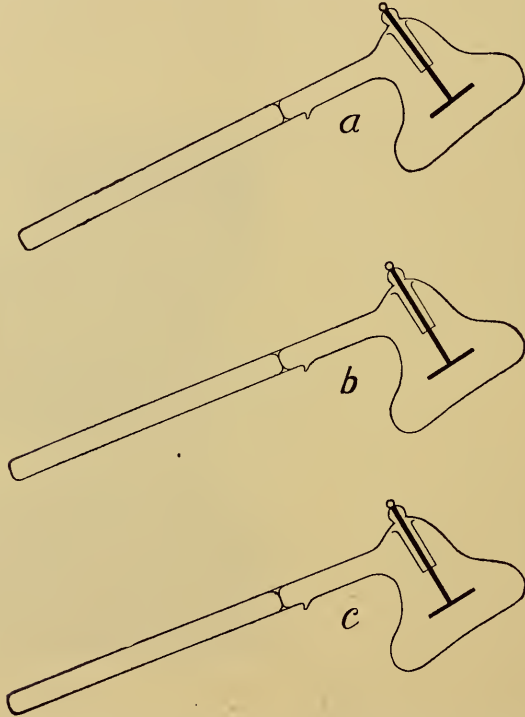

FIG. 137.—The Author's set of Condenser Electrodes.
a, "Low Red Vacuum." *b*, "White Vacuum." *c*, "X-Ray Vacuum."

and muscles which is of great value in the treatment of partial paralysis, incipient degeneration of the nerve centers, deep-seated pain, and in the removal of exudates and effusions. In common with all varieties of Multi-frequency Technic, the above method is to be avoided in cases of organic heart disease.

Some months ago the writer designed a set of Condenser Electrodes for the application of High-frequency Currents to the treatment of local conditions. This set consists of three Con-

denser Electrodes as shown in Fig. 137, and an Insulating Handle. Although identical in size and appearance these electrodes produce entirely different effects upon the tissues and functions of the body. The first is exhausted to a "Red Vacuum," approximating one five-hundredth of an atmosphere; the second, to a "White Vacuum," about one ten-thousandth of an atmosphere, and the third, to a low "X-Ray Vacuum" about one one-hundred-thousandth of an atmosphere. The first electrode may be used in the majority of cases which are amenable to High-frequency Treatment. The distinctive effects of the low vacuum discharge being of a sedative character, relieving acute congestion and inflammation, allaying pain, and stimulating metabolism. The second electrode is adapted to the treatment of chronic and indolent conditions involving lowered vital resistance and impaired nutrition. It is of especial value in the treatment of pulmonary tuberculosis, cold abscess, varicose ulcers, psoriasis, and eczema. The third electrode combines the devitalizing and destructive effects of the X-Ray, with the vivifying stimulating action of the *Tesla* Currents, and is a most important improvement in the methods for the therapeutic application of the X-Ray to the treatment of lupus, epithelioma and other forms of malignant disease. It will be more fully described in the chapter on "High-frequency X-Ray."

CHAPTER XVII

THE HIGH-FREQUENCY CURRENT FOR THE PRODUCTION OF THE X-RAY

THE X-Ray, as originally discovered by *Professor Roentgen*, was obtained by the passage of a Unidirectional Current of high voltage through a *Crookes* Vacuum Tube exhausted to about one-millionth of an atmosphere. The peculiar emanations from the negative terminal of the tube had been already studied by *Lenard* who termed them the "Cathode Rays." These rays ordinarily confined to the interior of the tube, by the opacity of the glass walls, had been obtained outside of the tube by means of an aluminum window sealed over an aperture in the glass directly opposite the cathode. Aluminum being transparent to the cathode rays permitted their transmission to the outer air, where their properties could be directly studied. Among other phenomena produced by these rays, it was noticed that fluorescent substances, such as barium-platinum cyanide became brilliantly illuminated when placed in their path. In experimenting with a cardboard screen coated with the above chemical, *Roentgen* noted that the luminosity was produced not only near the aluminum window, but near the glass on all sides of the tube, even when the cardboard screen was interposed between the tube and the fluorescent film. In studying this effect the shadow of the operator's fingers were observed on the screen, the darker outline of the bones being clearly distinguished against the lighter shadow of the less opaque flesh.

In this way the X-Rays of *Roentgen* were discovered and subsequent investigations by their originator demonstrated their character, properties and practical possibilities. *Roentgen* showed that these new radiations were an ethereal counterpart or secondary product of the cathode ray, originating wherever the

latter rays collided with the glass walls of the tube or other resisting surfaces. The cathode rays are streams of *Negative Electrons*, projected at right angles from the surface of the cathode terminal of a *Crookes Tube*. These electrons move in straight lines through the highly exhausted space in the tube at a speed of about one hundred thousand miles per second, somewhat slower than light rays which travel at a rate of one hundred and eighty-six thousand miles per second. In other words the cathode rays would travel entirely around the earth at the equator four times in a single second, while a ray of light would perform the same journey seven and one-half times during an equal interval. Cathode rays do not travel ordinary air for any appreciable distance. In the low pressure of a *Crookes Tube* they move freely at a high velocity, their momentum being so great that when suddenly checked they produce incandescence, and sometimes actual melting of the thin platinum plate which forms the anode in the majority of X-Ray Tubes. They are readily deflected by a magnet, and the angle of deflection has a definite mathematical relation to the size and electrical capacity of the moving particles which constitute the stream. The tremendous importance of this fact will be recognized when it is stated that it is through the careful experimental application of the above law that the "*Negative Electron*"—the common unit of all expressions of matter and force—has been discovered, measured and weighed.

A comparison of the nature and properties of the cathode rays with those of the X-Rays of *Roentgen*, will enable the reader to obtain a clear understanding of the fundamental differences between these two intimately related types of radiant energy.

(A) In the first place the cathode rays consist of minute material entities, or electrical particles shot out perpendicularly from the surface of the cathode in a *Crookes Tube*, which come to rest or are checked by collision with the glass walls of the tube. The X-Rays on the other hand, consist of extremely short, rapid pulses in the ether, each of which originates at the point of contact between a single electron of the cathode stream, and the glass walls of the tube, the pulse being caused by the sudden impact of the collision.

(B) Cathode Rays readily pass through thin plates of aluminum, but are stopped by contact with almost any other solid substance. The X-Rays penetrate *all substances* to a greater or less extent, the opacity of bodies of matter to the X-Rays increasing as a rule, in proportion to their increase in density or specific gravity. Thus, light substances such as wood, paper, aluminum or magnesium are relatively transparent, while denser materials such as iron, glass and mineral specimens are more or less opaque. There are several exceptions to the above rule, the most important being the diamond, which despite its great density is almost absolutely transparent to the X-Ray, while "Paste Diamonds," quartz, and other imitations are relatively opaque. This has opened an important field for the practical commercial application of the X-Ray.

(C) The X-Rays resemble rays of light in that they both consist of vibrations or undulations transmitted by the ether, but the X-Rays may be compared to a succession of sharp "whip cracks"; light, by a similar analogy resembling a low musical tone from one of the bass pipes of an organ. From a like standpoint, the cathode rays may be compared to a stream of rapidly moving particles of sand propelled from a nozzle by a strong current of air. Each grain of sand may be taken to represent one of the electrons which form the cathode stream.

(D) Cathode rays may be deflected by a magnet, reflected, refracted or polarized. The X-Rays are unaffected by a magnet, and it is practically impossible to reflect, refract or polarize them.

(E) Both the X-Rays and the cathode rays produce phosphorescence or fluorescence in sensitive substances, discharge electroscopes by ionizing the air, and produce effects upon the film of sensitized photographic plates. The X-Rays produce cumulative effects upon the tissues of the body, destroying the trophic nerve influence and depleting the cellular vitality. This may even lead to the formation of extensive sloughing burns, from the necrosis and local death of the tissues in the path of the rays. The specific action of the cathode rays upon living tissues has not been definitely determined up to the time of writing.

The modern X-Ray Tube in its simplest form is shown in Fig. 138, which represents the type designed for use in connection with

the static machine. It consists of a thin bulb of Bohemian or calcium glass provided with two electrodes; the negative or cathode being a concave reflector of aluminum which is shaped so as to project the cathode rays toward a common point or focus in the center of the anode, which is a thin platinum plate set at an angle of forty-five degrees with the axis of the tube. The cathode rays in colliding with the anode are reflected at right angles and strike the wall of the tube in straight lines, radiating from the focal point, each line being continued in the space outside the tube in the form of an X-Ray. The higher the degree of exhaustion in the tube the shorter will be the wave lengths of the X-Rays it produces, and the greater their powers of penetration and frequency of vibration. In treating or examining dense or deep-seated tissues with the X-Ray, a so-called "Hard Tube" of a high degree of exhaustion will be required, while for the treatment of superficial conditions or for the examination of moderately thin structures, such as the hand, foot or forearm, a "Soft Tube" exhausted to a lesser degree, should be employed;

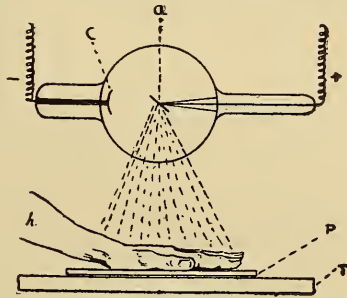

FIG. 138.—Method of Taking a "Skigraph."

a, Anode. *c*, Cathode. *h*, Hand of Patient. *P*, Sensitive Plate Enclosed in Opaque Paper Envelope. *T*, Table.

as it produces, longer, slower rays of lesser penetration, but affording pictures showing greater contrast and definition. "Hard" tubes resist the passage of the current and require a high voltage. The current from a static machine will readily jump across an air-gap several inches in length rather than pass through the highly rarefied gas in a "hard" tube. Such tubes exhibit an intense green surface fluorescence but show absolutely no light inside the bulb. "Soft" tubes, on the other hand, show flickering patches of bluish-white light between the electrodes, in addition to the green fluorescence, and possess such a low resistance that not more than one-half inch of spark can be backed up by them. Tubes for heavy X-Ray work require currents of considerable volume in order

to generate rays of high power and intensity. This large amperage gives rise to a great amount of heat, mainly at the focus of the cathode rays. Unless suppressed or absorbed, this heat would expend itself upon the anode, which would be rendered incandescent or perhaps actually melted, and in either event the

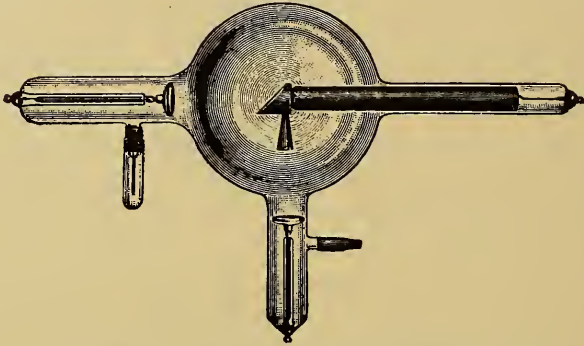

FIG. 139.—X-Ray Tube with Solid Metal Anode.

efficiency of the rays would be destroyed. Various means have been devised for obviating the undue accumulation of heat, such as the use of a solid metal-backing for the platinum anode as shown in Fig. 139, or by employing a cooling chamber filled with

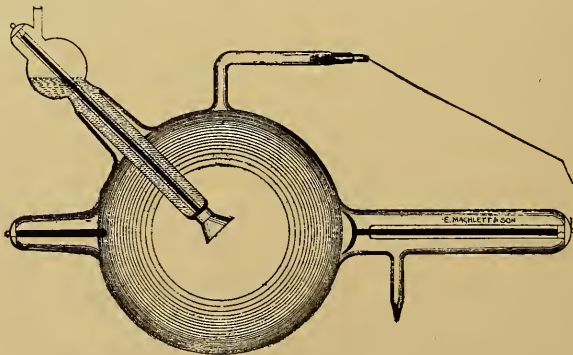

FIG. 140.—“Water-cooled” X-Ray tube.

water in relation with the under surface of the platinum plate. (See Fig. 140.)

The intense vibratory activity inside the X-Ray tube causes a gradual decrease in the number of residual air particles. These particles are either driven into the glass walls or are absorbed by

the minute specks of amorphous platinum driven off from the surface of the anode by the bombarding electrons of the cathode stream. The tube in other words, changes during continued use, from a "Soft Low Vacuum" to a "Hard High Vacuum." Ultimately such a high degree of exhaustion is produced that it becomes impossible to pass a current through the tube. In order to regenerate such a tube it may be refilled with air and again exhausted on a mercury pump or a small amount of gas may be admitted to the bulb by means of the vacuum regulator with which the majority of tubes are provided.

Although every maker of X-Ray tubes has his special form of vacuum regulator, there are but three fundamental types:

1st, Chemical Regulators, requiring external heat for the liberation of gas.

2d, Chemical Regulators operated by an electric spark.

3d, Osmotic Regulators depending upon the ability of certain metals to absorb hydrogen gas when heated.

Conventional examples of these three types of regulators are shown diagrammatically in Fig. 141.

(A) consists of a glass tube projecting from the side of an X-Ray bulb, having an enlarged rounded extremity containing potassium chlorate or manganese dioxide which liberates oxygen gas when heated by the application of a match or spirit-lamp to the outer surface of the glass tube.

(B) is similar in construction to the regulator just described except for the platinum wire, sealed into the portion of the tube containing the chemical. By allowing sparks from the coil or static machine to pass into the tube through the platinum wire, gas is liberated as in the first instance. An ingenious

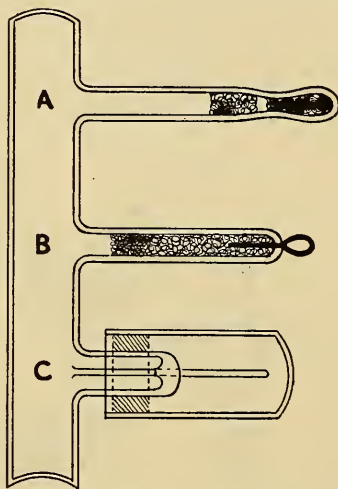

FIG. 141.—Vacuum Regulators for X-Ray Tubes.

A, Chemical Regulator, (Heat). B, Chemical Regulator, (Spark). C, "Osmo-regulator."

application of this type of regulator is found in the so-called "Self-regulating Tube" illustrated in Fig. 142. By means of an adjustable wire connected to the tube terminal farthest from the regulator, a spark-gap of any desired length may be formed between the point of the wire and the platinum terminal of the regulator. Suppose, for example, the wire be adjusted to form a gap of three inches. When the internal resistance of the tube becomes greater than that of the spark-gap, the current will take the path of the least resistance, passing across the gap to the opposite terminal of the tube by way of the chemical chamber of the regulator. Sparks will continue to pass until sufficient gas has been liberated to reduce the internal resistance of the

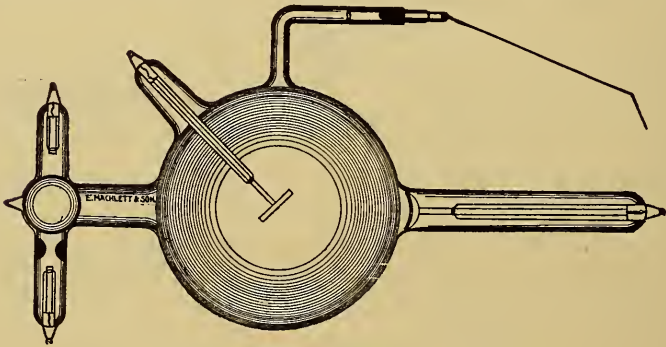

FIG. 142.—"Self-regulating" X-Ray Tube.

tube until it again forms an easier path for the current than the circuit containing the spark-gap. By this arrangement the tube may be maintained at a constant resistance for an almost indefinite period.

(C) represents a regulator of the Osmotic type which consists of an extremely small tube of metallic Palladium sealed into the side of the X-Ray bulb, the inner end of the metal tube being open, while the outer end is closed. Ordinarily the tube is protected by a cylindrical glass cap. If the latter be removed and the flame of a spirit-lamp be applied to the closed extremity of the Palladium Tube, Hydrogen Ions from the interior of the flame will be drawn through the inter-molecular spaces of the heated metal into the exhausted X-Ray bulb. The principal advantage of this type of regulator lies in the fact that the

vacuum may be reduced an indefinite number of times, while the life of a tube provided with a regulator of either of the preceding types is limited by the amount of the chemical in the end of the regulator tube.

In order to use *Tesla* Currents for the production of the X-Ray, a tube of special construction is necessary, as the oscillatory character of the current would soon destroy the efficiency of the ordinary tube of the unidirectional type. Various methods have been devised for the construction of High-frequency X-Ray Tubes involving three different principles: examples of tubes illustrating these ideas are shown diagrammatically in Fig. 143.

(A) shows the construction of the tube of the so-called "Double-focus" type invented by *Professor Elihu Thomson*. It is really a combination of two distinct tubes as will be seen by the imaginary dotted line dividing them. The oscillations in the direction of the arrow (X) produce X-Rays from the cathode and reflector in the right-hand half of the tube. The alternations in the opposite direction, indicated by the arrow (Y), produce a stream of rays shown at (Y) in the left-hand side of the tube. This is the most efficient type of High-frequency X-Ray Tube as it utilizes the energy of the entire current. It is admirable for therapeutic work but is not suited for skiagraphic examinations as the two points of origin of the X-Rays cause double outlines, which destroy the clearness of definition.

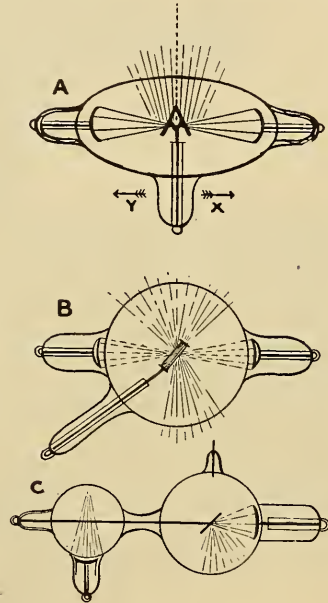

FIG. 143.—Types of "High-frequency X-Ray Tubes."
 A, Thomson Double Focus. B, Strong Double Focus. C, Single Focus (double bulb).

(B) shows a tube of the writer's design involving the same principle as the Double-focus tube but the rays, instead of being projected in two parallel streams are separated, those from the

oscillations in one direction, being reflected from the anterior surface of the platinum plate, while the rays from the opposite oscillations are reflected from the posterior surface of the plate. By mounting this tube in a dark box fixed in the center of a cloth screen or curtain, two independent examinations or

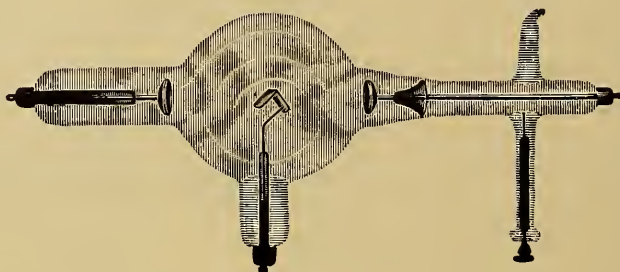

FIG. 144.—Thomson Double Focus X-Ray Tube.

treatments may be given simultaneously; the operator, for example, making a fluoroscopic examination of a fracture of the bones of the forearm, while his assistant is applying the rays for the treatment of a facial epithelioma, to a patient on the opposite side of the screen.

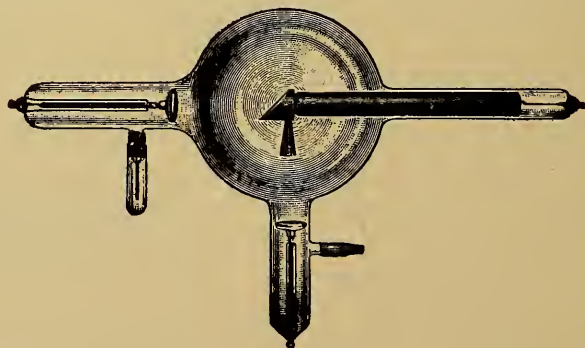

FIG. 145.—Single Focus Tube for H. F. Currents; with Hollow Metal Cone Under Anode.

(C) In tubes of the third type, the cathode rays from one set of oscillations are smothered or damped in a hollow metal cone or a closed glass bulb, while the opposite oscillations are employed for the production of the X-Ray, as in the usual unidirectional type of tube.

In Figs. 144, 145, 146, 147, are illustrated several commercial forms of High-frequency X-Ray Tubes, embodying the principles just described.

The X-Ray has been employed for some years in more or less successful treatment of malignant growths involving the superficial tissues or the mucous membrane, the principle of its action being its cumulative destructive effects on the vitality of the cells. Malignant growths being of a low grade of vitality and devoid of trophic nerve supply are killed by a smaller dosage of the X-Rays than would be required to devitalize the normal tissues in the vicinity. Great difficulty has been experienced, however, in accurately gauging the length and frequency of the

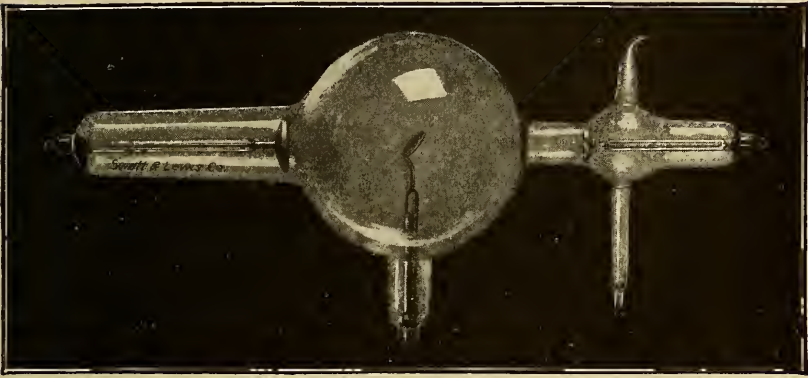

FIG. 146.—Single Focus Tube for H. F. Currents (Double Bulb Type).

treatments, and in many cases extensive areas of ulceration and sloughing have been inadvertently produced in the healthy tissues covering, or adjacent to the malignant growth.

Accidents of the above character have been practically confined to cases treated by X-Rays excited by a *Ruhmkorff* Coil or static machine. Several years ago the writer successfully demonstrated the possibility of causing the absorption of malignant growths without injuring the healthy tissues, by a combination of the X-Ray and High-frequency Current. The patient was connected to a *Tesla* terminal by a metal hand-electrode and an electrode of the vacuum condenser type exhausted to an X-Ray Vacuum was connected to the opposite terminal and applied

to the surface of the body in immediate relation to the tumor. The increase in the vitality in the normal cells through the stimulation of the trophic nerves by the High-frequency Current counteracts the depleting effects of the X-Ray on the healthy

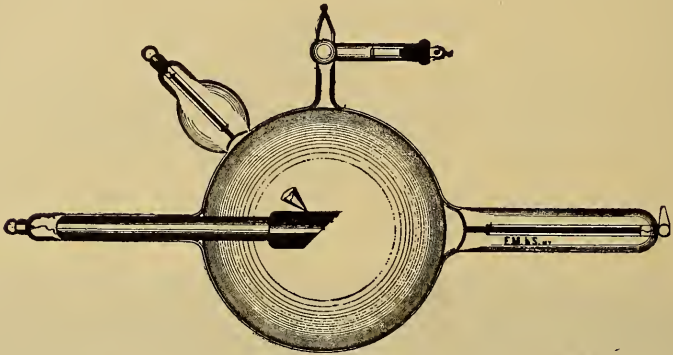

FIG. 147.—Latest Type X-Ray Tube for Either Direct or Alternating Currents.

tissues and concentrates it upon the cells of the malignant growth.

Some of the special methods devised by the writer for the treatment of deep-seated and inaccessible tumors are described in the chapter devoted to the "High-frequency Treatment of Malignant Growths."

CHAPTER XVIII

THE GENERATION OF THE ULTRA-VIOLET RAY BY HIGH-FREQUENCY CURRENTS

SOME years ago *Doctor Finsen* of Denmark began a series of clinical experiments for the determination of the therapeutic action of light rays. He first employed the sun's rays in his experiments, afterward substituting the light from a powerful arc lamp consuming eighty amperes, and provided with carbons containing salts of iron. He demonstrated the curative value

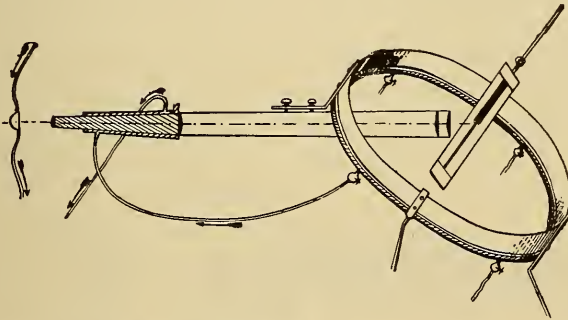

FIG. 148.—Diagram of Finsen's Arc Lamp. (Guilleminot.)

of light rays in the green, blue, violet and ultra-violet portions of the spectrum, in the treatment of lupus and superficial cancer. In order to obtain any degree of penetration he found it necessary to force the blood from the area of treatment by means of a quartz lens or compress. Daily treatments lasting for an hour or more were given for months or even years in order to produce the curative effects. (Fig. 148.)

Only a comparatively small percentage of the rays from *Finsen's* Lamp were beyond the violet end of the spectrum, and these consisted of wave lengths only slightly shorter than the visible rays in the extreme violet. It is possible, however, to

produce ultra-violet rays of considerable volume nearly an octave higher than those obtained by *Finsen*. For the generation of these rapid ultra-violet rays, a High-frequency Current is employed, discharging across a short spark-gap between iron electrodes. Many of the bright lines in the spectrum of iron are

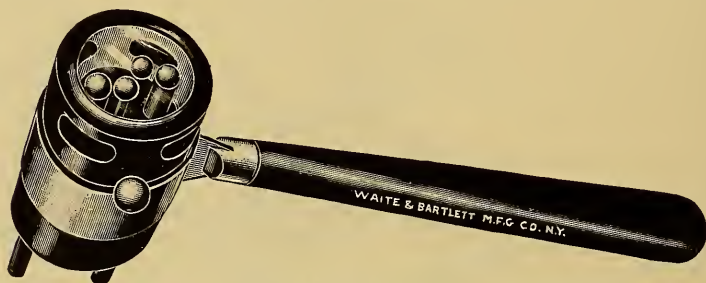

FIG. 149.—Piffard's Spark-gap Lamp.

beyond the violet and by the rapid oscillations of the current these short rays are given greater intensity than the iron lines in the visible part of the spectrum.

Rays of the above character may be obtained from a *Ruhmkorff* or static machine by connecting the terminals to a *Piffard*

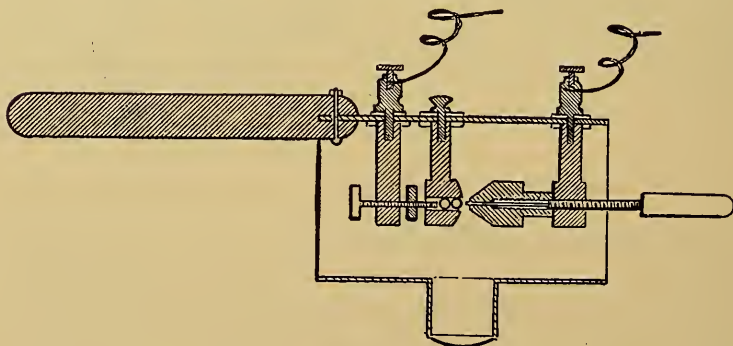

FIG. 150.—Strong's Ultra-violet Lamp for Use with "Ajax," or "Hercules" Coils.

Spark-gap Lamp in series with a small *Leyden Jar*. *Doctor Piffard's* Lamp which is shown in Fig. 149, consists of two or more short spark-gaps between small iron balls, mounted in a hard rubber tube covered with a quartz lens. Rays of even greater intensity may be obtained from a lamp of a type designed

by the author which is illustrated in Fig. 150. It consists essentially of a single adjustable spark-gap between the convex surface of a small steel ball projecting from an aperture in a circular brass terminal, and the end of a small steel rod which passes through a hole in the opposite terminal of the lamp, the upper end of the rod being held in a micrometer screw provided with a hard-rubber handle regulating the length of the spark. The lamp is covered with a metal canopy provided with a quartz lens for the transmission of the rays. The terminals of the lamp are connected to the discharging circuit of the condenser in the writer's High-frequency Apparatus, the ordinary spark-gap being thrown out of circuit and the small balls and disks of the *Tesla* Terminals being pushed into contact in order to short-circuit the High-frequency Coil.

The rays are of extremely short wave length and high frequency. Glass, mica, celluloid and gelatin are absolutely opaque to these rays which, however, readily pass through plates of quartz, selenite or rock salt. They produce active fluorescent or phosphorescent phenomena as described below. Under certain conditions they possess the power of ionizing the air, increasing the length of spark-discharges and discharging charged electroscopes or *Leyden* Jars. Applied to the exposed surface of the human body, these rays produce redness, congestion and blistering, in a single sitting of from thirty to forty minutes. They produce pain and redness in the human eye, and the operator should, therefore, wear spectacles with large glass lenses when working with the rays. The value of these rays as therapeutic agents has been demonstrated by the successful treatment of a large variety of acute and chronic skin diseases and in affections of the peripheral nerves. When employed for the latter purpose, the tissues to which the rays are to be applied should be de-hematized by the use of a solution of adrenalin, cataphorically diffused by means of the galvanic current.

For experimental demonstration in lectures, etc., brilliant effects may be produced by subjecting specimens of the following substances to the ultra-violet rays from one of the above-described lamps:

Eosin	(Aqueous Solution)	= Green Fluorescence.
Fluorescein	“ “	= Yellow Green Fluorescence.
Æsculin	“ “	= Sky-blue Fluorescence.
Quinin Bi-sulphate	“ “	= “ “ “
Cylinder Oil		= Yellow Fluorescence.
Willemite		= Bright Yellow Green Fluorescence.
Calcite		= Salmon-pink Fluorescence.
Fluorite		= Amethyst Fluorescence.
Uranium Glass		= Apple-green Fluorescence.
Didymium Glass		= Dull Red Fluorescence.
Lead Glass		= Sky-blue Fluorescence.
Calcium Tungstate		= Bright Blue Fluorescence.
Barium Platinum Cyanide		= Yellow Fluorescence.
Calcium Sulphide		= Bright Blue Phosphorescence.
Zinc Sulphide		= Yellow Phosphorescence.
Diamond		= White Phosphorescence.
Selenite Crystals		= Yellow White Phosphorescence.
Aragonite		= Blue White Phosphorescence.

An interesting effect is produced by powdering certain of the above substances and painting pictures with them, using a medium of gum-arabic solution, or silicate of soda. These pictures show no color when exposed to the ultra-violet rays, when a plate of glass is held over the quartz lens of the lamp, but when the glass is removed the designs at once appear in brilliant tints.

CHAPTER XIX

THE GENERATION OF OZONE BY THE HIGH-FREQUENCY CURRENT

OZONE is a heavy gas of an extremely penetrating odor which is produced by the discharge of High-potential Currents, particularly the High-frequency Type, across gaps filled with oxygen or air. From a chemical standpoint ozone is an Allotropic form of oxygen, containing three, instead of two atoms to the molecule. When introduced into the lungs or other mucous cavities of the body, ozone acts as a powerful germicide and disinfectant. It destroys the toxic products of bacteria through its power as an oxidizing agent and is said to exert a tonic stimulant effect upon the cardiac and respiratory functions.

Ozone has been highly exploited and undoubtedly greatly overestimated as a therapeutic agent, but on the other hand, it has been unjustly condemned by many physicians who have employed it in an impure condition. The principal obstacle to the therapeutic use of ozone as produced from ordinary air by the static or High-frequency Discharge is the large proportion of poisonous oxides of nitrogen which is simultaneously produced. Various means have been devised for the removal or absorption of these impurities, such as passing the ozone through tubes containing lime, or solutions of the alkaline hydrates or carbonates.

An apparatus has been placed upon the market in the last few years which is designed solely for the production and therapeutic administration of ozone derived from ordinary air. It consists of a "step-up" transformer which raises the potential of the commercial alternating current to about 40,000 volts. A pair of multiple tubular condensers are excited by the High-potential Current of the transformer and the air in their interior is rapidly converted into ozone by the silent discharge between the glass-

covered metal rods which form the condenser. A continuous current of air is forced through the condensers by means of an electric fan in the lower part of the apparatus and the ozone mixed with nitrous fumes passes through leather tubes to the inhaling masks. Just before entering the latter the mixture of gases passes through glass "U" tubes partially filled with an oily liquid, containing aromatic products combined with terpin and camphor derivatives. The makers of the apparatus place great stress upon the properties of this liquid, which they claim not only completely absorbs the nitrous products but forms a volatile, unstable compound with the ozone which breaks up in the lungs into nascent oxygen, and an active chemical germicide. These generators are employed by a considerable number of

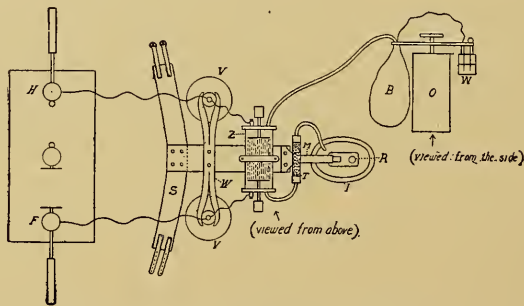

FIG. 151.—Strong's Apparatus for the Treatment of Pulmonary Tuberculosis.

physicians throughout the country, many of whom claim to have obtained remarkable results, especially in cases of pulmonary tuberculosis. Up to the present time no scientific clinical tests of this apparatus have been made by any of the recognized authorities. Pending such information no definite opinion can be given regarding the actual therapeutic possibilities of this method of treatment.

The writer has recently constructed an apparatus for the treatment of pulmonary tuberculosis and other diseases of the respiratory system, which he believes to be the first device for the scientific generation of chemically pure ozone ever employed for therapeutic purposes. A diagram of this apparatus is shown in Fig. 151. It consists of a frame, provided with straps for attaching the apparatus to the thorax of the patient, supporting

two vacuum condenser electrodes by a transverse rod of hard rubber. These electrodes are exhausted to a white vacuum and are adjustable, so that their action can be directed to any desired area. Ordinarily, they are symmetrically placed so as to cover the central portion of the right and left lung respectively, as shown in the figure. Each electrode is connected to a terminal of the *Tesla* Coil in series with an adjustable air-gap between metal disks, studded with points; each of the two gaps being enclosed by a glass cylinder provided with tight-fitting hardwood caps. Through tubulated apertures at both ends of the glass cylinder, the interior of the spark-gap chambers are connected in series so that air forced into one chamber will pass through it into the second whence it will be conducted through a glass tube to a rubber-edged inhaling mask supported on an adjustable spring arm attached to the frame of the apparatus. In administering the treatment the patient reclines at full length, the apparatus being strapped on his chest so as to bring the vacuum electrodes in contact with the body over the right and left lungs, while the mask is adjusted in light contact with the face of the patient covering the nose and mouth. The current is turned on, and the small disks in the glass cylinders are adjusted until a dense effluve, an inch or more in length is produced at each gap. Pure oxygen gas from a steel cylinder provided with a rubber bag and wash bottle is conducted through the two spark chambers to the inhaling mask over the face of the patient, in its passage across the gaps, a portion of the oxygen is converted into pure ozone and the mixture of the two gases is inhaled by the patient. Just before passing into the face mask, the ozonized oxygen passes through a small nebulizer by means of which the vapors of aromatic or antiseptic liquids may be simultaneously administered to the patient. The writer has obtained excellent results by the use of the compound which is supplied to the profession under the proprietary name of "Pineoleum," in connection with the above apparatus. As this device was constructed by the writer something under three months ago, it is impossible to cite clinical evidence of its value in the treatment of pulmonary tuberculosis; however, the remarkably rapid improvement of the few cases which have been treated, up to

the present time, certainly warrants the writer in his belief that this method of combined treatment by therapeutic agents which have individually been widely employed in the successful treatment of tuberculosis, will prove to be the most efficient means yet produced for the ultimate eradication of civilization's most potent foe, the "Great White Plague."

CHAPTER XX

A REVIEW OF MODERN THERAPEUTIC METHODS

THERAPEUTICS in its broader sense may be defined as the science of treatment, or the art of healing the sick. Recent investigations have shown that the various functions of the body result from the action of vibratory electrical forces in the nerves upon the chemical compounds which constitute the different cells and tissues.

The vital functions may be classed under the following heads:

1st, Psychic functions, including the phenomena of consciousness, volition and reason, which result from the action of subtle physical forces, the exact nature of which is at present unknown.

2d, Special sense perception including, (a) vision, (b) hearing, (c) taste and smell (a single function manifesting through two channels).

3d, General sensory perception which includes touch or tactile impressions, the sense or appreciation of weight, and the sense of pain (the latter being an abnormal effect).

4th, Motor functions, involving the voluntary or involuntary contraction of muscle fibers.

5th, Secretory functions, involving the elaboration or formation of definite chemical compounds by groups of specialized cells.

6th, Metabolism, or vital combustion, a function inherent in each individual cell, whereby it absorbs its quota of nutriment from the blood or lymph, together with oxygen from the red corpuscles, and builds them into its own structure, transforming their potential energy into the primitive vital forces of living protoplasm. With the exception of the first and last group, the various bodily functions depend upon electrical vibrations, which they receive from the nervous system. Each function is expressed by cells or organs, which are specialized or peculiarly

adapted for their particular work, and which are associated with a special set or system of nerve fibers, transmitting electrical vibrations of a certain definite frequency.

Thus the contractions of muscles depend upon vibrations averaging about four thousand per second, which traverse the so-called "*Motor Nerves*" as the result of a voluntary or unconscious impulse originating in the brain. The sensation of touch, on the other hand, undoubtedly results from an electrical vibration between 10,000 and 15,000 per second, which traverse the sensory nerves as a result of stimulation of the nerve endings in the skin, and carry to the brain a knowledge of the location and nature of the external stimulus. The auditory nerves carry to the brain a series of sound or tone perceptions, ranging from thirty vibrations, to 40,000 per second, while the optic nerve transmits as color impressions, ether waves of radiant energy varying from 350 million-million (red light) to 750 million-million (violet light). The nature of the emanations which produce the sensations of smell and taste are at present unknown, but they are probably vibratory. It has not been definitely determined whether the electrical vibrations, traversing the optic and auditory nerves, correspond in frequency to the light rays and sound waves which respectively produce them; this is probably the case with sound, which is the result of mechanical vibrations—while light, which results from electro-magnetic disturbances of the ether, probably induces in the optic nerve, electrical oscillations of a much lower frequency, but harmonically related to the luminous rays which produce them.

There are two other functions of living tissue which have not been included in the above classification—namely, a sense of heat and cold, probably transmitted through the sensory nerves; and the so-called "trophic influences," which enable the different cells of the body to resist destructive and disease-producing agencies, and to maintain a condition of health and structural integrity. This trophic influence does not result from a definite range of vibrations of a special set of nerves, but appears to be associated with the nerves in general; thus, if a *motor nerve* be destroyed, gradual atrophy and degeneration will occur in the muscles corresponding to that particular nerve. Again, a

destruction of the optic nerve will be followed, not merely by loss of sight, but by the wasting away of the corresponding eyeball. Most forms of disease are the direct or indirect results of the diminution or cessation of the trophic nerve influence of an organ or group of organs. For example, as a result of overwork, lack of sleep, and improper food, the potential nervous energy of a given organism is greatly depleted; one of the first results of this lack of energy is impaired circulation of the blood, which leads or predisposes to a chilling of the surface of the body, and a congestion and capillary stasis of the mucous membrane of the upper respiratory passages; this is the first stage of the so-called "catching cold." The ever-present disease-producing bacteria, take advantage of the temporary absence of their hereditary foes, the *leucocytes*, or *white corpuscles*, which are the "protective police" of the bodily tissues, and which are prevented from reaching and destroying the bacteria by the stasis or congestion of the capillary blood-vessels in which they are confined, and the disease germs therefore rapidly multiply and produce poisonous toxins, which are absorbed into the tissues and produce grave disturbances in the already depleted nerve currents, thereby giving rise to various functional derangements. In a short time the trophic or vital nerve currents of the entire body are so greatly depleted that extreme prostration and even death may occur. The functions of digestion, assimilation and circulation, are seriously impaired and the source of supply is thereby cut off. The abnormal conditions resulting from the absorption of bacterial poisons, sometimes involve the liberation in the nerves of powerful electrical vibrations of a different frequency from those to which the nerves are attuned, giving rise to serious functional manifestations. Thus the tetanus bacillus, when accidentally introduced into the blood stream through a wound, in the course of its multiplication, produces a toxin or poison, which, while extremely small in amount, and utterly insignificant from a purely chemical standpoint, possesses the power of liberating in the motor nerves, electrical vibrations of so powerful a nature as to give rise to terrific motor spasms; the muscles often being torn from their attachments by the intensity of their contractions. Still other forms of bacteria produce through

their toxins, interruptions or "short-circuiting" of the motor nerves, and paralysis results.

It will be seen, therefore, that the majority of the phenomena of disease result from disturbances of the electrical equilibrium of the nervous system. The therapeutic use of drugs, which has been almost the sole resource of the medical profession in past years, involves the stimulation or suppression of different functions through the administration of medicines, and is so obviously empiric and unscientific, that the more progressive portion of the profession have grasped eagerly at every new method of healing in the hope of finding a more rational and satisfactory basis for the treatment of disease. The study of bacteriology has shown that the white corpuscles of a healthy body are capable of preventing, or limiting infectious disease, by the secretion of chemical substances, or so-called "*Antitoxins*," which neutralize the poisonous products of the bacteria. When a patient recovers from an infectious disease, his restoration is due to the fact that the leucocytes of his blood have succeeded in forming sufficient antitoxin to neutralize the bacterial poisons; and the disease germs, thus deprived of their principal offensive weapon, are picked up and devoured by the white blood cells, carried to the spleen, where their dead bodies are burned up, and excreted from the body. The antitoxins remain in the blood for a considerable time and protect the patient from a second infection of the same nature. This so-called "*Immunity*," follows a mild attack and is as effectual as when produced by a severe infection. This forms the basis of our protective vaccination against smallpox. A more scientific application of the same principle is the antitoxin treatment for diphtheria and tetanus.

The trend of modern thought in medical circles is along the lines of prophylaxis and hygiene; that is, the study of methods for the prevention of disease and the preservation of health.

We are beginning to realize the fact that the healthy organism contains within itself the elements which protect it from the encroachments of disease, and that even in cases where bacteria obtain access to such a system by the way of wounds or abrasion of the surface, their infection will be of a mild form, of short

duration, and confined to a small area. Hygiene, consisting in careful attention to the laws of health, plenty of sleep, out-of-door exercise, wholesome food, bathing, etc., is now taught in all of our schools, while the large number of periodicals and magazine articles treating of various hygienic subjects, is in itself a striking evidence of the intense practical interest manifested by the masses in this most important evolutionary movement. Under the influence of public sanitation and personal hygiene, we may legitimately hope for the absolute suppression of all forms of infectious disease within a few generations. Meanwhile, however, the medical profession will be called upon to continue its present work of fighting acute and chronic manifestations of disease in the individual, and it only remains for the physician to decide what particular method, or methods of treatment are in his opinion best suited for the purpose. The empiric use of drugs has constituted nine-tenths of the therapeutics of the past century. The obviously unscientific character of such a system of treatment has long dissatisfied its followers. Attempts to formulate drug therapy into a science have met with but little success up to the present time. *Hahnemann's* Homeopathy, based upon the so-called "Law of Similars," has been heralded as the true solution of the above problem and a considerable fraction of the medical profession are followers of this system. A careful and conservative study, both from a clinical and theoretical standpoint has led the writer to the conclusion that, while a limited number of powerful drugs act in accordance with a theoretical "Law of Similars," a much larger percentage of the various substances used as medicine absolutely refute *Hahnemann's* hypothesis; and unfortunately the nature of therapeutic drug action is not one which admits of solution by the present experimental methods of the scientific laboratory. The above conclusions regarding the reliability of the Homeopathic system apply equally well to the doctrine of "Specific Medication" as taught and applied by the so-called "Eclectic Practitioners." According to this hypothesis, for each and every disease to which the flesh is heir, Nature has conveniently and most accommodatingly provided a "specific" remedy, and it only remains for the physician to determine the particular

substances related to the different diseased conditions in order to obtain a complete and scientific system of therapeutics.

The writer wishes it to be distinctly understood that he is neither condemning nor denying the curative possibilities of drugs; on the contrary, that valuable results may be obtained from remedies whether they be applied in accordance with the principles of homeopathy, eclecticism or empiricism is a truth which he has conclusively demonstrated in his own practice; but that individually or collectively these systems satisfactorily solve the problem of the treatment of disease, he most emphatically denies.

The great objection to *all* these methods lies in the fact that they approach the problem of disease from the wrong standpoint. If the home of a Western pioneer be attacked by a band of hostile Indians, his first impulse would naturally be to seize his rifle and endeavor to kill the marauders; experience, however, would have taught him the fallacy of such a course of action, and before beginning offensive operations he will do everything in his power to strengthen his defense. After barring the doors, closing his windows with heavy shutters, and placing his women and children in the cellar out of the way of stray bullets, he will then, *and only then* return the fire of his savage adversaries. The application of the above illustration is obvious; instead of endeavoring to kill the disease germs and to remove or suppress the symptoms produced by their toxins, by the administration of different drugs, we should use every means in our power to stimulate and assist the organism to call to its aid the different defensive and protective resources with which *Nature has provided it*. Inasmuch as we know that the disease-producing agencies are as a rule readily overpowered and destroyed by the natural, vital and resistive forces which are present in the body of a perfectly healthy individual and which exist potentially even in weak organisms, the obviously ideal method of treating disease would be to infuse into the patient's organism artificial forces of the same physical nature as those which maintain health and destroy disease in the body of a person of normal health and vigor. This is all very true, theoretically, but is it possible in actual practice to generate and apply vitalizing

forces of the above character? The ultra-conservative physician, whose practice consists of the empirical use of drugs along lines practically similar to those followed half a century ago, will reply unequivocally "No!" But the progressive practitioner of the "twentieth-century type," who is conversant with the development of *Physical Therapeutics* during the last decade, will answer as emphatically in the affirmative. It is not only theoretically possible to produce artificial forces similar to those which maintain health and vital activity in the normal human body, but we *have produced*, and *are employing* at the present day, therapeutic agencies, which, if not actual duplicates of the nerve vibrations through which Nature maintains health and functional activity, are at least sufficiently like these forces in that they increase vital resistance, reestablish depleted functions and assist in the elimination and suppression of disease-producing agencies. These forces comprise the *Electrical Vibrations*, known as "Alternating Currents of High and Low Frequency," and their etheric counterparts, namely, the various forms of *Radiant Energy*.

CHAPTER XXI

PHYSIOLOGICAL ACTION OF OSCILLATORY CURRENTS

BEFORE attempting a consideration of the effects produced by High-frequency Currents upon the functions and constitution of the bodily tissues, it may be well to briefly review the physiological and therapeutic action of the simpler forms of electrical energy, which have been employed in the treatment of disease.

Under the latter head may be mentioned:

- (A) The Constant Galvanic Current.
- (B) Interrupted Galvanic Current.
- (C) The Slow Faradic Current of Low Voltage.
- (D) The Rapid High Tension Faradic Current.
- (E) The Sinusoidal Alternating Current.
- (F) General Electrification with the continuous High-potential Current from a Static Machine.
- (G) The Static Breeze.
- (H) The Static Brush or Spray.
- (I) The Static Spark.
- (J) The Static Induced Current.
- (K) The Static Wave Current.

The galvanic current is continuous, of low potential and high amperage. It is obtained from a series of battery cells, or from a shunt from the Edison 110-volt Direct Current. The effects of its continuous passage through the body are mainly due to the chemical action of the products of the electrolytic dissociation of the salts dissolved in the tissues. Chlorin and other acid products are liberated at the positive electrode; caustic soda and hydrogen gas forming at the negative pole. If the current be sufficiently strong, cauterization will be produced, a hard, red scar resulting from the action of the anode, while the tissues at the cathode are converted into a white soapy substance. The latter action is exemplified in the destruction of urethral stric-

ture, superfluous hair, and small tumors by negative electrolysis. The physiological action of the galvanic current is sedative, hemostatic and germicidal near the anode; and stimulating, congestive and counter-irritant on the tissues in the vicinity of

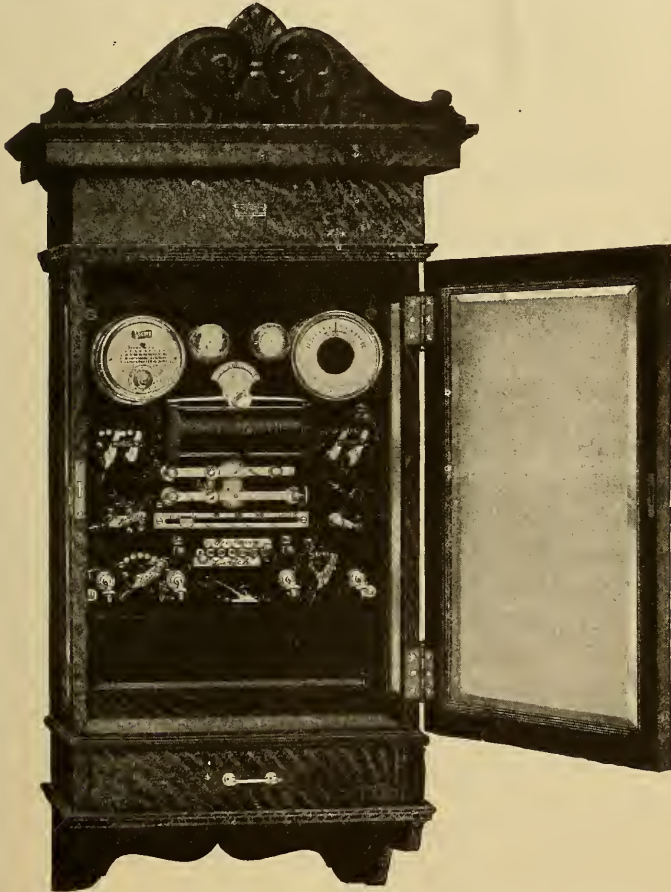

FIG. 152.—Apparatus for Generating Galvanic and Faradic Currents from Battery Cells or Edison 110 Volt "Direct" Circuit.

the cathode. This current is also employed for the dissemination of various remedial agents through the tissues of the body. (Fig. 152.)

The interrupted galvanic current and the slow low-tension Faradic current produce very similar effects upon the human organism, their action being mainly upon the muscles and motor

nerves. They are employed therapeutically as a substitute for massage, producing clonic contractions of the muscles; a form

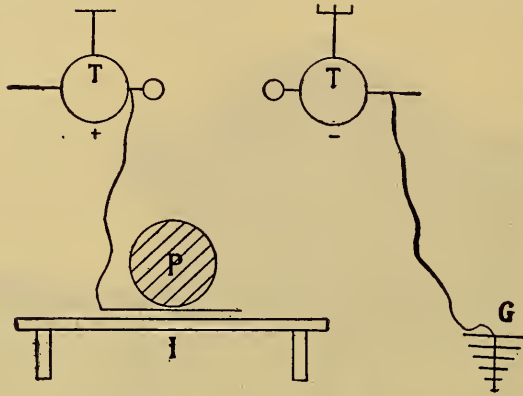

FIG. 153.—Diagram of Static Electrification.

of “passive exercise” of value in cases of rheumatism, partial paralysis and muscular stiffness.

The rapid High-tension Faradic Current, and the induced current obtained from small *Leyden Jars* connected to a static machine (*D* and *J*), are very similar in their effect upon the organism, and are employed for the relief of pain of nervous origin, such as neuralgia, sciatica, herpes zoster, etc. (Fig. 156.)

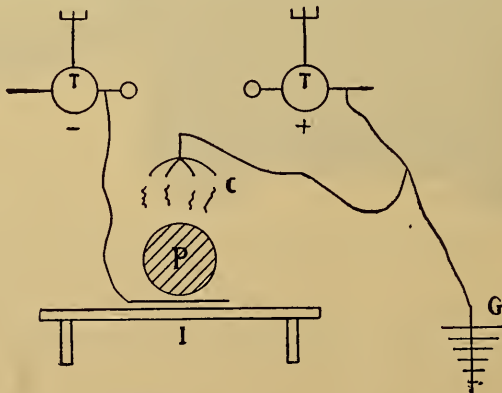

FIG. 154.—“Static Breeze.” (Diagram.)

The sinusoidal current, by producing smooth wave-like contractions of the muscles, causes alternate influx, and expression

of the blood in the tissues near the electrodes, thereby increasing local nutrition, oxidation and elimination. It has been more or less successfully employed in the treatment of rheumatism and gout, and in the absorption of exudates, effusions, etc.

The general effects of static electricity are of a restful sedative character, relieving insomnia, headache, and reflex neuroses. The

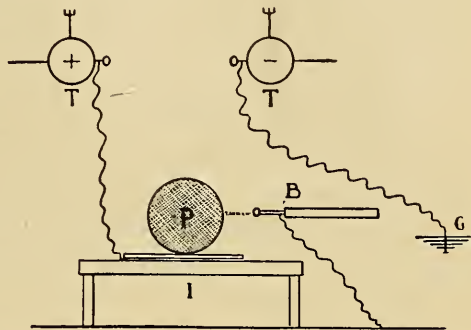

FIG. 155.—Diagram of Static Spark Treatment.

“breeze” and “brush” stimulate the peripheral nerves, increasing circulation and relieving superficial pain. (Fig. 154.)

The static spark produces profound contractions of the deep-seated muscles and is therefore of value in the treatment of rheumatic and paralytic affections, involving structures in the interior of the body which cannot be reached by the Faradic or interrupted galvanic currents. (Fig. 155.)

The static wave current produces rhythmic contractions of a less profound, but more widely diffused character. It is of especial value in the relief of chronic inflammatory conditions. It is also used in the treatment of rheumatism, gout and spinal disease. (Fig. 157.)

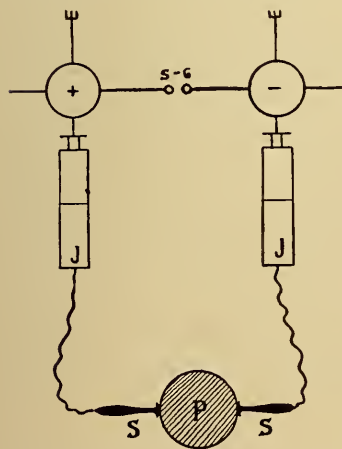

FIG. 156.—Diagram of Static Induced Current.

It will be noted that all of the above modalities produce effects of a stimulating character; in other words, they merely incite the different types of nerves to the liberation of vibratory energy, thereby depleting the vital resources, although temporarily increasing their activity. This effect may be compared to

the action of a blast of air on the waning fire of a furnace. The intensity and energy of the combustion is temporarily increased, but at the expense of the already depleted fuel. It is easy to put coal on the fire but it is not always easy to give back to the body the vital energy expended through the action of tonic and stimulant agencies.

In sluggish or dormant conditions involving diminished circulation and accumulation of waste products, counter-irritant or stimulant applications will often re-establish functional activity and restore the healthy action of the body, providing the latter be well nourished and in possession of sufficient reserve energy to withstand the temporary overdraft on its resources.

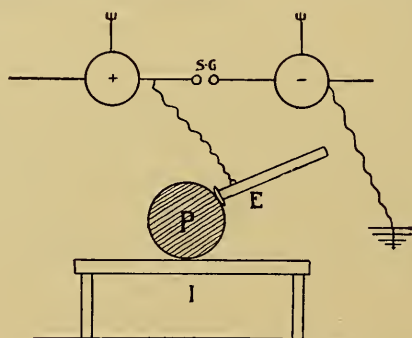

FIG. 157.—Diagram of Static Wave Current.

Where the vitality has been already greatly depleted, however, as in the advanced stages of pulmonary tuberculosis, or in a patient just recovering from typhoid fever, the use of powerful stimulants, whether electrical or medicinal, would doubtless be attended with almost immediate fatal results. In these cases the chief resource of the physician has been to carefully husband the already depleted vitality, by rest and general relaxation, meanwhile endeavoring to recharge the body with potential energy by the aid of concentrated nutriments, given in a pre-digested form.

High-frequency Currents, more especially those of the *Tesla* type, possess therapeutic powers which are not exhibited by any of the remedial agents known to the profession. In passing through the body of a person whose vitality has been almost

exhausted through the encroachments of disease, these currents appear to promote circulation, increase metabolism, and more or less completely restore the general harmony between the different functions of the body, seemingly without the slightest expenditure of the scanty residue of vital energy stored up in the cells and tissues. In other words, we have in these currents a means of increasing vitality without the necessity of digesting, assimilating and storing the nutritive material which ordinarily carries the potential energy which forms the single source of supply for organisms belonging to the animal kingdom.

While a certain amount of nitrogenous material must be periodically assimilated for the repair of the worn-out cells and tissues of the human body, the larger portion of our food supply is simply a cumbersome and unscientific source of energy for the performance of the various bodily functions. Vegetables obtain their energy directly from the sun in the form of radiant heat and light, and it should therefore be quite possible for man to obtain his energy directly, provided a vibratory force could be obtained which would be capable of ready diffusion through the tissues and absorption by the nerve centers. To a certain extent, the *Tesla* High-frequency Current possesses the above-mentioned requirement, and the next decade will probably witness the satisfactory demonstration of the ability of properly attuned electrical vibrations to take the place of the entire food supply with the exception of a small amount of proteid material for tissue repair.

The physiological action of currents of high frequency is primarily exercised on the cellular chemical processes, increasing the vital combustion both in quantity and intensity, and facilitating the elimination of waste products. There is an increase in vaso-motor activity and a slight rise in arterial tension; the oxidizing power of the blood is increased, a fact of great importance in the treatment of gouty conditions, inasmuch as it involves the conversion of the uric acid deposits into soluble urea. There is a peculiar inhibitory effect produced by High-frequency Currents upon the peripheral nerves. Local anæsthesia may be produced in this way and the reaction of the superficial tissues to Galvanism and Faradism is sensibly dimin-

ished. The use of the High-frequency Arc for the cauterization of moles and warts involves a similar inhibitory effect which is shown by the fact that a discharge which at first causes pain soon renders the area practically anæsthetized.

High-frequency Currents have been found capable of sterilizing cultures of pathogenic bacteria and of destroying the toxicity of their poisonous products. This fact explains their therapeutic value in the local treatment of abscesses and septic ulcers by the effluve, and the successful treatment of pulmonary tuberculosis by the application of the *d'Arsonval* or *Tesla* Currents through the methods of auto-conduction and auto-condensation. Experiments on tubercular guinea pigs by *Doctors Lagriffoul* and *Denoyes*, have shown that an actual inflammation is produced upon the tubercular nodules by the High-frequency Currents, which are subsequently entirely freed from their bacilli by the phagocytic action of the leucocytes.

Ever since the High-frequency Currents were first exploited for therapeutic purposes, great interest has been manifested in the peculiar immunity of the human organism to currents of this description even when their volume or amperage is several times the amount necessary to produce instant death if the frequency of the currents were low instead of high. One of the first explanations of this peculiar "paradox" was based upon the assumption that High-frequency Currents did not actually penetrate the body and were conducted entirely upon its surface. While this might be true in the case of the homogeneous metallic conductor, it has been demonstrated that these currents are really transmitted through all parts of the human organism, the latter being a complex structure whose tissues differ widely in their conductivity for electrical oscillations. The explanation suggested by *d'Arsonval* is more in accord with the facts deduced from clinical experience, than the hypothesis of surface conductivity above described. *D'Arsonval* attributes the destructive effects of the Low-frequency Currents of High Amperage to the intense secondary oscillations which they excite in the different types of nerves. In the motor nerves, for example, a Low-frequency Current of one ampere would excite such intense vibrations as literally to tear the muscles from their

sockets. If not of sufficient amperage to destroy life or consciousness, the Low-frequency Currents produce intensely painful sensations through the secondary oscillations which they induce in the sensory nerves. Currents of high frequency, on the other hand, oscillate with such rapidity that no sensory or motor effects are produced, inasmuch as all electrical vibrations beyond 10,000 per second lie beyond the limits of the range of frequencies to which these nerves respond.

While the theory of *d'Arsonval* satisfactorily explains the passage of High-frequency Currents of great volume through the human organism without injury to the latter, it is not in the writer's opinion the only reason for the immunity of the body. Careful investigation of the action of Low-frequency Currents in cases where death has been produced by their passage through the body have shown that in addition to the injuries resulting from the excessive vibrations induced in the various nerves, there is more or less serious destruction of the more delicate tissues, such as the axis cylinders of the nerves, which can be explained only by the resistance which these structures offer to the current and the mechanical disturbances resulting from the forcible overcoming of this resistance by the electronic streams. If a dam be built across the path of a river, the water will be held in check, and only a small amount will overflow. If the volume and force of the current be increased, and if certain portions of the dam be imperfectly constructed, the force of the stream will break down the resistance at the weak point, and in this way the entire dam may be destroyed. This homely analogy will illustrate the destruction of the nerve filaments, and the subsequent death of the entire body through the forcible passage of the streams of electrons which constitute a continuous or Low-frequency Current. In discussing the physical properties of High-frequency Currents, attention has been called to their freely flowing through non-conductors and bodies of high resistance; the absence of the usual interference phenomena having been explained by the fact that these "*Currents*" are in reality *not currents at all*, but *transmitted electrical vibrations*. The destructive interference phenomena, due to the passage of heavy currents through high resistance, are mere friction effects,

occasioned by the passage of matter through matter. The passage of a High-frequency Current, however, involves only the transmission of energy. A continuous or Low-frequency Current may be compared to a stream of air flowing through a tube, while the high frequency resembles sound waves transmitted through a similar tube. In the first instance, energy is transmitted in company with moving matter; in the latter the energy is transmitted by the vibration of stationary matter. Thin rubber diaphragms stretched across the pipe, in the first instance, would either stop the stream of air, or be ruptured and disintegrated by its forcible passage. Diaphragms of this kind would interfere scarcely, if at all, in the passage through the tube of energy in the form of sound waves. Let it be remembered, therefore, that High-frequency Currents are simply forms of vibration, and are consequently transmitted by any elastic medium, irrespective of its electrical conductivity.

It is this fact which explains the immunity of the human body to the passage of High-frequency Currents of great volume.

The use of High-frequency Currents for therapeutic purposes, produces remarkable curative effects, many of which can be satisfactorily explained only by the assumption that we have in these currents a rough counterfeit or substitute for the peculiar nutritive flux transmitted through the nerves to all tissues of the body to which we give the name "*Trophic Influence.*" It is this trophic power which enables the cells to absorb their quota of nutriment from the blood, to maintain their vital resistance, and to perform their various functions. The exact manner in which the High-frequency Currents replace or regenerate the trophic influence, has not been definitely determined. That they really act in the above manner will be evident from a consideration of some of the cases cited in the chapters on "*Special Therapeutics.*" The increase in the trophic and secretory nerve forces produced by the passage of High-frequency Currents is very much more intense in connection with the High-tension Currents from a *Tesla* Coil, than with the Low-tension Currents of *d'Arsonval*. The *Tesla* Currents also exert a more powerful action on the vaso-motor system and are therefore of the utmost value in the relief of passive con-

gestion, whether occurring as a result of the depletion of the forces of the sympathetic nervous system, as a symptom of organic renal or cardiac disease, or in the initial stages of the acute infectious fevers.

The secretory functions of the body, involving the action of the various glandular structures in the elaboration of the different digestive ferments, etc., are strongly stimulated by the action of the currents from a *Tesla* Coil. In cases of nervous dyspepsia, for example, where gastric digestion is absolutely suspended, owing to the lack of the sympathetic nerve currents, which in the healthy organism, incite the glands of the gastric mucosa, to the secretion of hydrochloric acid and pepsin, the application of the *Tesla* Current seems to temporarily restore or replace the lacking nerve force, inasmuch as the secretion of the gastric juice almost invariably follows the direct High-frequency Treatment of the sympathetic nerve centers.

In addition to the general vitalizing, invigorating, and harmonizing effect produced by the passage of the *Tesla* Currents through the human body, there are a number of local effects peculiar to the different methods employed in the application of the current to the affected areas. The differences in the physiological action of the various methods of treatment depend primarily upon the nature of the discharge and the peculiarities in the form, material and construction of the active electrode. As a consideration of the distinctive physiological action of the various methods for the local application of High-frequency Currents involves the discussion of the different pathological conditions amenable to treatment by the respective modalities, the writer has included both of the above subjects in the ensuing chapter on the "Therapeutic Effects of High-frequency Currents."

CHAPTER XXII

THE THERAPEUTIC ACTION OF HIGH-FREQUENCY CURRENTS

IN studying the therapeutic action of oscillatory currents of high frequency, the modalities or methods of application may be considered in the following order:

(A) Currents of relatively Low Voltage and High Amperage.

Methods of production:

- (a) *D'Arsonval* Solenoid.
- (b) Primary *Tesla* Coil.
- (c) "Thermo-Faradic" Coil.

Methods of Application:

(I) Direct Treatment.

- (a) "Stabile" with Stationary Electrodes.
- (b) "Labile" with Movable Electrode.

(II) Indirect Treatment.

- (a) Auto-Conduction with *d'Arsonval* "Cage."
- (b) Auto-Condensation with Condenser Couch.
- (c) Combined Treatment with the *Piffard* Condenser Spiral.

(B) Currents of Very High Potential with Relatively Low Amperage.

Methods of Production:

- (a) *Oudin* Resonator with *Ruhmkorff* Coil.
- (b) *Tesla-Thomson* Coil with Alternating Transformer.
- (c) The *Piffard* "Hyperstatic" with *Holtz* Machine.

Methods of Application:

(I) Monopolar Treatment, including:

- (a) Direct Application by means of
 - (I) Effluve.
 - (II) Pseudo-Static Spark.
 - (III) Arc (High-frequency Cautery).
 - (IV) Vacuum Electrodes.

(b) Indirect Application of the same Modalities.

(II) Bipolar Treatment including:

- (a) *Tesla* Effluve.
- (b) *Tesla* Spark.
- (c) *Tesla* Vacuum Treatment.
- (d) Double Vacuum Treatment.
- (e) Double Effluve Treatment.
- (f) *Tesla* Auto-Condensation with Couch.
- (g) *Tesla* Auto-Condensation with Vacuum Condenser Chair.

(III) Multi-frequency Methods including:

- (a) "High-frequency Wave Current" by Effluve Interruption.
- (b) "Motor Impulse Current" with Spark Interruption.
- (c) "Pseudo-Faradic Current" with short Arc Interruption.

(IV) Condenser Effluve or *Piffard* "Trans-Resonator Current."

(A) *D'Arsonval* Currents

The Low-potential High-frequency Currents of large volume are similar in therapeutic effects, and methods of application, whether obtained from a solenoid, primary *Tesla* or "Heat Coil." Their physiological action is exerted mainly upon the cellular functions and the chemical processes of the body, increasing tissue combustion, promoting osmosis, and stimulating metabolism and elimination. For this reason the *d'Arsonval* Currents find their principal field of usefulness in the treatment of chronic and constitutional diseases, involving derangements of nutrition, metabolism and cell growth, such as diabetes, rheumatism, gout and obesity. They are also of value in the local treatment of diseases involving progressive wasting of certain tissues or organs, such as tuberculosis, chronic bronchitis and muscular atrophy.

In the first class of conditions the treatment is best administered by the indirect methods, with the cage or condenser couch. Practically the same results are produced in both methods, but it is sometimes advantageous to substitute couch treatment for

that of the cage, or vice versa, in cases where the modality first employed does not produce the desired effect. (Fig. 158.)

For general diseases with local manifestations, such as rheumatism, and gout, direct treatment should be employed with stable application, with a large sponge-covered pad over the solar plexus, a vessel of warm salt water in which the feet are

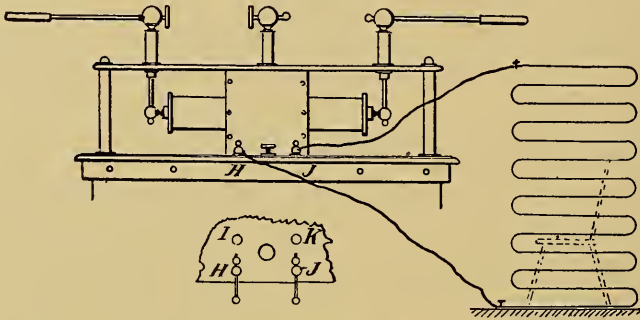

FIG. 158.—D'Arsonval Auto-conduction Cage Operated from the Author's "Hercules" Coil."

immersed forming the opposite electrode. The *labile* method involves the use of a stationary electrode usually consisting of a sponge-covered metal pad which should be wet with a salt solution, and placed over the spine or solar plexus, and a movable electrode consisting of a small sponge-covered disk fixed in the end of an insulating handle. (Fig. 159.) These electrodes are connec-

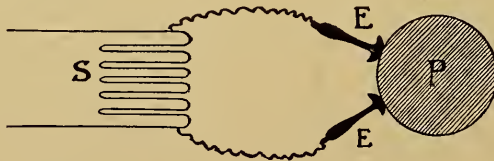

FIG. 159.—Diagram of "Labile" Method for Solenoid Currents.

S, Solenoid. P, Patient. E, E. Sponge-covered Electrodes, to be Kept Moving During Treatment.

ted to the respective poles of the solenoid, and the small disk is moved slowly over the affected area during the entire treatment. From one to five hundred milliamperes may be administered in the above manner, while if the small electrode was allowed to remain stationary, not over two hundred milliamperes could be administered without inflaming or blistering the skin. (Fig. 160.) This

does not apply in the case of *large* electrodes as described in connection with the *stabile* method. In addition to the general effect on metabolism, the *labile* method as above applied, produced local counter-irritant effects, and has given good results in relieving congestion and stasis, in sub-acute bronchitis and allied conditions. It is also useful in relieving pain in cases of sciatica, tic-doloureux and traumatic neuritis. Whether applied directly or indirectly, a milliamperemeter should always be placed in series with the patient in the solenoid circuit. With the condenser couch or *Piffard* Chair (see Fig. 114) the meter should be connected in series with the terminal to which the metal hand electrodes are attached. In the *labile method*, the meter should be on the same side of the circuit as the stationary sponge-covered pad.

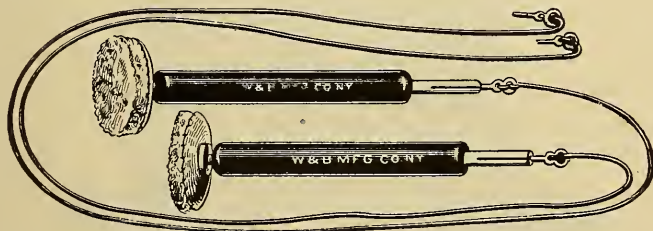

FIG. 160.—Sponge-covered Electrodes for "Labile D'Arsonvalization."

For general hospital use the horizontal cage and condenser couch are best adapted, while for office treatment the *Piffard* Chair with special condenser cushion, or the *Piffard* Combined Spiral and Solenoid, will prove equally effective, and decidedly more convenient. (See Figs. 109 and 110.)

(B) *Currents of Very High Potential with Relatively Low Amperage*

The High-voltage Currents obtained from a resonator or *Tesla-Thomson* Coil differ from the *d'Arsonval* Currents in that they produce less marked effects upon the chemical processes of the cells, while more intensely stimulating the nerves of the sympathetic and vaso-motor systems, and exerting a peculiarly characteristic action on vital resistance and trophic influence.

Among the European practitioners these High-potential High-frequency Currents are employed mainly in the treatment

of local conditions, being derived as a rule from an *Oudin Resonator*.

As the resonator currents are monopolar, they are obviously unsuited for the treatment of conditions of a diffused or general character. In America, on the other hand, High-potential High-frequency Currents are generally of a bipolar nature, and are employed in accordance with the technic originated by the author, using an apparatus of the *Tesla-Thomson* Type excited

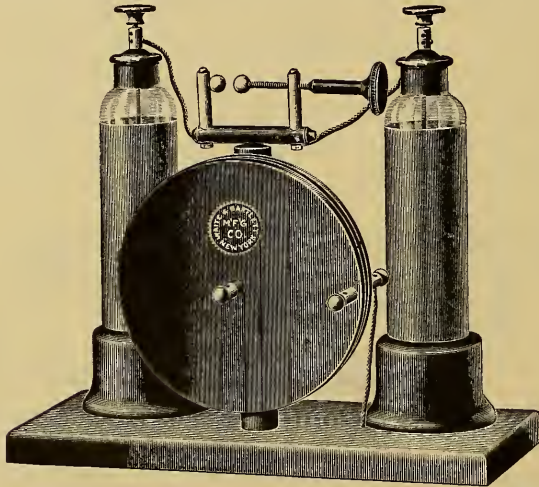

FIG. 161.—Piffard's Small Spiral with Condensers; for Use with Ruhmkorff Coil.

by an alternating current transformer, or from a *Piffard Hyper-Static Coil* attached to a *Holtz Machine* or *Ruhmkorff Coil*.

Owing to their bipolar origin, the *Tesla* Currents may be used as *carriers for vibrations or waves of lower frequency*. The application of this principle, as exemplified by the writer's *Multi-frequency Modalities*, has opened an entirely new field for the development of electro-therapeutics, and has greatly broadened and enlarged the range of usefulness of the currents of high frequency and high potential.

No. 1.—*Monopolar Treatment*

Direct local application of High-potential High-frequency Currents is administered by means of various types of electrodes, attached to the terminal of an *Oudin Resonator* or *Tesla Coil*.

The most familiar type of resonator treatment is the so-called effluve, consisting of a purple brush discharge of from one to twelve inches in length, obtained by the use of single or multiple metal point electrodes. (See Fig. 115.) The length of the effluve is determined by the number of turns in the solenoid, the length of the spark-gap and the strength of the exciting current. The effluve produces a sensation of warmth upon the skin to which is added a feeling as if a succession of miniature hailstones were falling upon the surface.

If the distance between the electrode and the body be diminished to the point where the discharge shows a tendency to change from the effluve to the spark, an almost painful sensation is produced from the bombardment of the skin by the rapidly moving ions. Continued application of the latter description produces redness, congestion and even blistering if the treatment be unduly prolonged. As a rule the effluve should not be given with the electrode at the above minimum distance, the latter being employed only in the treatment of indolent ulcers, and where it is desired to produce artificial inflammation as in psoriasis, chronic eczema, etc.

In the usual effluve treatment, the electrode is held just near enough to cause an agreeable tactile sensation on the part of the patient.

The effluve produces a threefold effect upon the tissues of the body, the first being due to the action of the electrical oscillations transmitted through the air-gap, and radiating through the tissues near the treated area. These oscillations relieve congestion, stimulate nutrition, and increase the activity of the vasomotor system and trophic nerves. The second effect of the effluve results from the *ionic bombardment* of the treated surface and is of a stimulating counter-irritant nature. The third effect is due to the ozone and nitric oxides liberated by the effluve and driven by it into the superficial tissues; the germicidal action of the effluve on septic ulcers, pyogenic infection and parasitic skin diseases is no doubt largely due to the production and diffusion of the above gases. In addition to these effects, there are other distinctive results of effluve treatment, which will require further investigation for the determination of their exact nature and

therapeutic value; they are produced by the action of the secondary ether vibrations resulting from the oscillatory discharge, which probably include rays in the blue, violet and ultra-violet together with heat waves and Hertzian radiations of different periodicities.

The "Resonator Effluve" is of value in the treatment of a large variety of local affections, particularly those of a septic or inflammatory type, and has given excellent results when combined with *d'Arsonval* treatment in cases of general diseases with local manifestations, especially pulmonary tuberculosis.

The "Pseudo-Static Spark" and the method for its production and application have been described in a previous chapter. It is of comparatively little value when derived from the single terminal of a resonator, but may be used with good results over the spine as a substitute for the actual cautery, in the treatment of chronic ulcers with exuberant granulations and for the relief of pain in obstinate neuralgic conditions where other methods of application have failed.

The "*Direct Arc*" from a resonator or *Tesla* Terminal was first employed for cautery purposes by the present writer in the removal of small superficial tumors, and as a substitute for incision in cases of carbuncle, and acute superficial abscesses. After the first few seconds, but little pain is experienced, owing to the anæsthesia produced by the discharge through inhibition of the sensory nerve currents. Virulent septic foci have been successfully sterilized and the toxins destroyed in a number of cases treated by the writer by the use of the High-frequency Arc. It is only fair to state, however, that in the majority of the above cases, an indirect arc from a *Tesla* Coil was employed, and it may be questioned whether the same results would have been produced if the direct arc from a resonator had been used.

Direct application of the resonator discharge by means of glass electrodes, containing rarefied gases or some other conducting substances, produces a series of effects quite different from those obtained from the modalities above described. When the glass surface of the electrode is in direct contact with the skin, the discharge passes to the latter in an even regular manner, concentrating the oscillatory effect on the tissues immediately

under the electrode, without producing the surface irritation which results from the bombardment of the effluve and spark. The vitalizing effect of the current on the tissues near the glass electrode is even more intense than with the effluve, as is also the action on the trophic and vaso-motor nerves, but the stimulation and counter-irritation resulting from effluve treatment is almost entirely lacking when glass electrodes are used. This applies more especially to electrodes of the Low Red-vacuum type. Electrodes of the latter class are more generally used in the application of High-frequency Currents than either the effluve or those which involve the use of a solid conductor surrounded by an insulating covering of glass or hard rubber. The last-named variety possesses no advantages over low vacuum electrodes except in cases where special stimulation of mucous cavities is desired. Even in these cases the vacuum electrode may be made to produce identical results by simply covering it with one or more layers of cloth or chamois leather. (Fig. 162.)

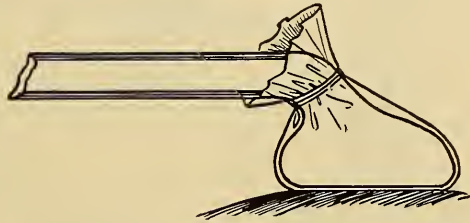

FIG. 162.—Vacuum Electrode Covered with Chamois Skin.

When applied directly to the skin or mucous membrane, vacuum electrodes produce practically no sensory effect other than a slight warmth. In addition to their trophic and vaso-motor effects, they exert a sedative action upon superficial tissues which renders them of value in the relief of acute congestion and local inflammation. They tend to break up areas of infection by relieving stasis, promoting phagocytosis, and dispersing exudates. Swelling and effusions of traumatic origin are promptly relieved and ecchymosis prevented by immediate application of the Red-vacuum electrode. Acute coryza, tonsillitis, acute urethritis, and cervical adenitis, all yield readily to this variety of treatment provided the electrode is employed in the incipient congestive stage, and before the tissues have become infiltrated with small round cells and leucocytes.

In more advanced stages of the above diseases, as well as in other sub-acute inflammations involving mucous cavities, electrodes of the "White-vacuum" type, exhausted to less than one ten-thousandth of an atmosphere, will probably produce satisfactory results.

The difference between the White- and Red-vacuum electrodes, so far as their therapeutic action is concerned, depends upon the difference in frequency and wave-length between the secondary oscillations and waves of radiant energy produced by the electrical vibrations in their respective vacua. With the White-

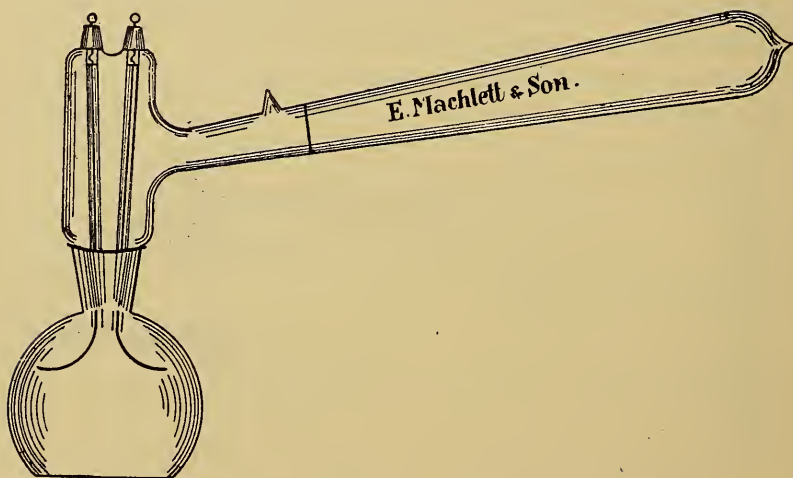

FIG. 163.—Ultra-violet Vacuum Lamp with Quartz Lens.

vacuum electrode a considerable portion of the secondary radiations consist of light waves in the blue violet and low ultra-violet. (Fig. 163.)

The high ultra-violet rays which are produced in the tube are absorbed by its glass walls, but by means of a device originated by the writer, these ultra-violet rays may be added to the therapeutically active emanations from the electrode. This is accomplished by means of a quartz plate hermetically sealed in the end of the glass electrode, behind which is placed a disk of aluminum which is connected to the resonator terminal. By the introduction of mercury vapor into a tube of the above type, the ultra-violet rays may be greatly increased in intensity. Owing

to the difficulty and expense attending their construction, these electrodes have not been generally employed, but the writer has obtained excellent results from their use in the treatment of acne, eczema, sycosis and epithelioma.

The use of vacuum electrodes of the customary construction and form, but exhausted to an X-Ray vacuum instead of the usual "Low Red" has been already referred to in a previous chapter. Electrodes of this type were first introduced by the writer for the treatment of malignant diseases of the skin, and mucous membrane, and have given excellent results not only in these conditions but in the treatment of chronic inflammatory affections of an indolent and atrophic type, which proved

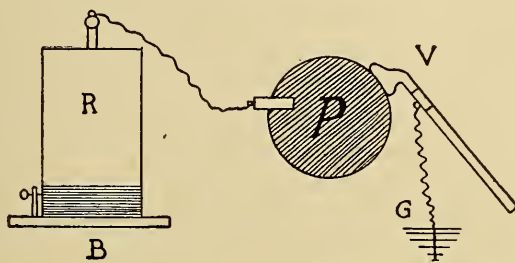

FIG. 164.—"Indirect Vacuum Treatment:" R, Resonator, or Tesla Coil Terminal.

refractory to treatment by means of electrodes of the White-vacuum type.

The term "Indirect Treatment" is applied to those methods of administering the discharge from an *Oudin* Resonator, in which the patient is directly connected to the latter by means of a metal electrode, and the current localized or drawn out of the body by means of an electrode connected with the ground or the body of the operator. (Fig. 164.) Although frequently employed with the conventional *Oudin* Resonator discharge, treatment by indirect application is of much greater efficiency both constitutionally and locally, when given by means of a modern *Tesla* Apparatus. The writer's "Ajax" Machine is especially adapted for this purpose.

The effluve from a metal point electrode is seldom used indirectly; but the arc, spark and vacuum treatment are frequently employed in this manner. Indirect methods have the

advantage over the simpler direct application, in that the entire organism is subjected to a vibratory bath by the electric oscillations while the local effects penetrate more deeply. The secondary local action is less intense, however, unless the current be derived from a *Tesla* Coil instead of a resonator. With the former apparatus almost as powerful discharges may be obtained after the current has passed through the patient's body as those resulting from the direct application of an *Oudin* Resonator Current.

The indirect spark produces a perceptible effect upon the motor nerves somewhat similar to that of the static spark, although the resemblance is less marked than when the bipolar or *Tesla* Technic is employed. It is of value in the local treatment of muscular and articular rheumatism, gout, neuralgia, etc.

The indirect arc was employed by the writer in his first experiments in the use of the High-frequency Discharge for cauterizing purposes. The technic for its application has already been given. The direct use of the resonator arc for the same purpose as subsequently suggested by *Oudin*, does not seem to produce equally satisfactory results. This is probably due to the fact that the *Tesla* Current consists of a series of almost uninterrupted oscillations, and consequently produces more intense heating effects than the arc from the resonator.

Freund enumerates a series of effects produced by the High-frequency Arc and Spark on various forms of bacteria, and areas of infection artificially produced in rabbits and guinea pigs. He gives detailed accounts of these and other experiments, which show the bactericidal and destructive effects of High-potential Discharges. As much of the evidence adduced was derived from experiments with discharges of low frequency, the writer has deemed it unnecessary to incorporate a detailed review of the above researches in the present volume.

It may be remarked in passing that the skeptical attitude exhibited by *Freund* toward the therapeutic possibilities of High-frequency Currents is similar to that of a number of physicians, both abroad and in this country, who have taken up the study of electro-therapeutics as a result of special research and practical application of the X-Ray. Just why the *Roentgen*

specialist should adopt a skeptical attitude not only toward electro-therapeutics, but toward the electro-therapeutist as well, is a difficult question to answer. It is a generally accepted fact, however, and may perhaps explain the ultra-conservatism of certain well-known authorities in discussing the therapeutic possibilities of electricity.

The indirect arc may be substituted for the *actual cautery* except in the destruction of inaccessible growths such as polypi in the nasal or uterine cavities. Indirect application of the *Tesla* Current by means of vacuum electrodes, has been employed by the writer in the great majority of the cases in his clinics and office practice during the past ten years. He believes this method to be the most satisfactory form of High-frequency Treatment, inasmuch as it admits of the simultaneous production of vitalizing and curative effects upon a local lesion and the general system. The usual technic involves the connection of the patient to a *Tesla* Terminal and the application of the vacuum electrode held directly in the operator's hand, or fixed in an insulating handle connected to the ground through a steam or water pipe. In the case of patients of a highly susceptible nature who object to the slightest stimulation, the constitutional effects of the maximum current of the machine may be obtained with a minimum of local stimulation by the following modification in technic. A vacuum electrode in an insulated handle is applied to the affected area and instead of a direct ground connection with the electrode, a second vacuum tube is employed. The latter is held in the left hand of the operator, and after the current is turned on, the second tube is brought within sparking distance of the glass surface of the active electrode, near the point of its attachment to the insulated handle. By varying the distance between the two electrodes or by moving the tube in the left hand nearer to the part of the insulated electrode which is in contact with the body, the strength of the current may be regulated. The second electrode together with the spark-gap between the glass surfaces forms a sort of rheostat, regulating and limiting the local discharge of the current. By this method the mildest possible vacuum electrode treatment may be given, as, for example, in cases of eye trouble or in the treatment of

an acutely inflamed ear drum. This method is also of value in the treatment of an extremely nervous patient.

No. 2.—Bipolar Application or Tesla Technic

For bipolar application, a *Tesla* Apparatus of the type introduced by the writer, having the triple terminals already described will be required. Apparatus of the same character but of different make may be used with the addition of a set of the above terminals. The following methods of application involve the production of secondary waves of relatively low frequency, superimposed upon the rapidly oscillating *Tesla* Current. These Low-frequency Effects are, however, comparatively weak and do not properly belong to the group of modalities which the writer has termed "Multi-frequency Currents."

The administration of the *Tesla* Effluve involves the direct connection of the patient to one terminal by a metal electrode held in the hand, or preferably, applied over the solar plexus, the opposite terminal of the coil being connected to a metal point or brush electrode from which the effluve is applied in the usual manner.

A peculiarity of the *Tesla* Effluve is the wave-like sensory and motor effect obtained in the tissues near the metal electrode by successively lessening and increasing the distance between the metal points and the patient's body. Application of the latter procedure in the treatment of functional and organic disease of the nervous system, such as tabes, lateral sclerosis, progressive muscular atrophy, spinal irritation and general nervous exhaustion, has yielded excellent results in the writer's clinical practice.

The stationary electrode should be in the form of a fairly large plate of block tin applied to the surface of the body over the solar plexus. It should be carefully adjusted so that its upper margin is separated by a distance of at least one inch from the surface immediately over the cardiac apex. The effluve electrode should be moved up and down the spine, its central point following a spiral path as indicated in the diagram shown in Fig. 165. By reversing the position of the electrodes, and applying the effluve in a spiral path over the ascending, transverse, and descending colon, excellent results may be obtained in the

treatment of chronic constipation, hepatic torpor and general intestinal atony.

By substituting an electrode ending in a small metal ball or point for the multiple point or wire brush used with the effluve, the "Pseudo-Static," or "*Tesla Spark*" may be obtained. The apparatus should be adjusted to give a rather weak current, and the spark-gap should be as wide as possible without disturbing the continuity of the discharge. The spark may be directed upon the surface of the body; may be given through the clothing; or may be applied to disks of tin-foil placed upon the skin over the motor points. Contractions of the muscles will be produced by the last-named method, both at the point to which the spark

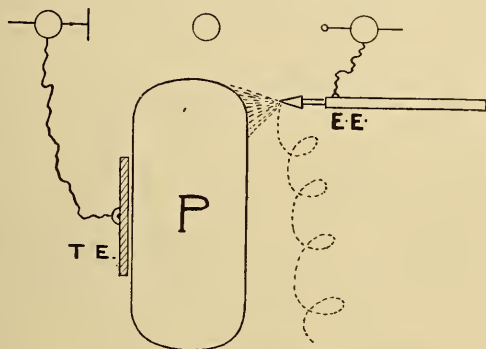

FIG. 165.—Rhythmic Effluve Treatment for General Stimulation.
T. E., Block-tin Electrode.

is applied and in the tissues near the metal electrode. (It is, of course, understood that the latter electrode should be connected to the *Tesla Terminal* as for the application of the effluve.) The *Tesla Spark* combines the general effect of the *Tesla Currents* with a stimulating action upon the nerves and muscles, resulting from the super-imposed Low-frequency Wave. When employed with the tin-foil disks, the *Tesla Spark* is practically identical with the writer's "*Motor Impulse Current*" described in Section III. The conditions in which the *Tesla Spark* produces the most satisfactory results are mainly those affecting the motor nerves and muscles. They will be considered individually in the ensuing chapters. (Fig. 166.)

The writer's method for the application of *Tesla Currents* by

means of vacuum electrodes may be carried out in two ways. 1st, by direct connection of the patient to the *Tesla* Terminals by a metal electrode on the one side and a vacuum electrode on the other. 2d, by connecting the vacuum electrode to the

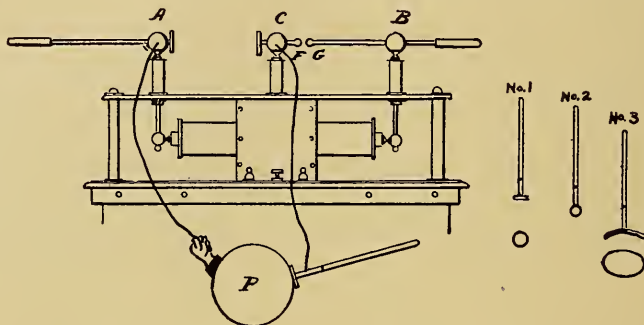

FIG. 166.—“Motor Impulse” Treatment.

dummy terminal, and adjusting the intensity of the local effect by varying the length of the effluve between the two brass disks (see Fig. 167). The first modification produces such intense action near the vacuum electrode as to cause the latter

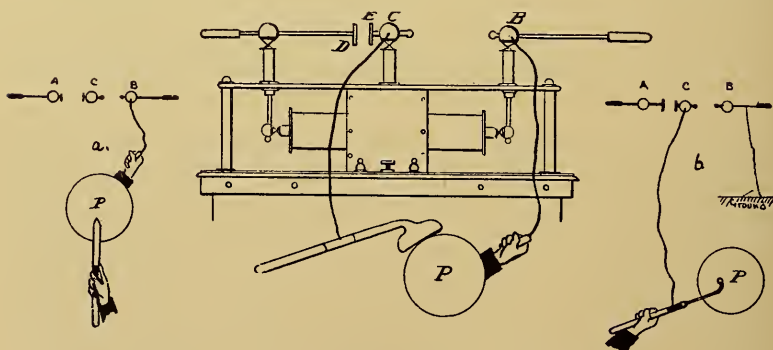

FIG. 167.—The Author's Technic for Vacuum Electrodes.

to grow extremely hot. For this reason the treatment must be given intermittently and for not more than one minute at a time. No effect is produced upon the motor nerves by this method, nor does it appreciably increase arterial tension. It may there-

fore be used for the relief of dropsical effusions occurring in organic or kidney disease, and in the later stages of pulmonary tuberculosis. Where the electrode is connected to the dummy, in series with the variable effluve, there is more or less of the "wave effect" produced, and this technic is therefore contra-indicated in organic heart disease, as it increases the rapidity of the pulse, and lessens the inhibitory action of the pneumogastric nerve. For the same reason this method is indicated in the treatment of diseases involving poor circulation, functional anæmia, insomnia, and dyspepsia due to depleted nerve force.

For intense local action the double vacuum electrode treatment may be employed, as for example, in pulmonary tuberculosis when

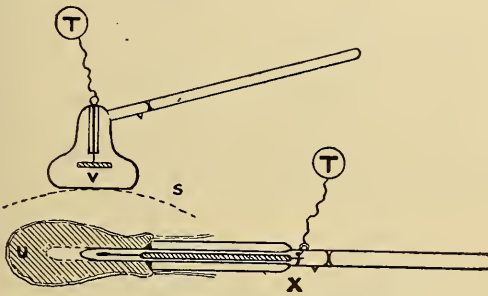

FIG. 168.—The Author's Treatment for Diseases of the Uterus.

X, Uterine Electrode Pumped to an "X-Ray Vacuum." V, "Low Red" Vacuum Condenser Electrode Applied to Supra-pubic Region.

we wish to concentrate the entire effect of the current upon the diseased lung tissues. (See Fig. 169.) An example of this technic has been described in connection with the writer's apparatus for the combined treatment of thoracic disease by the *Tesla* Current and ozonized oxygen. The double vacuum method is also of value in the treatment of affections of the mucous cavities; for example, the writer's latest method for the treatment of cancer of the uterus involves the use of an internal vacuum electrode exhausted to an X-Ray Vacuum, connected to one *Tesla* Terminal and a bulb-shaped electrode of the vacuum condenser type applied to the surface of the body just above the pubes; the latter electrode is exhausted to a Low Red-vacuum and is connected to the opposite terminal of the *Tesla* Coil. (See Fig. 168.)

The double effluve treatment may be given in a similar manner substituting the appropriate metal points for the vacuum electrodes in the above technic. (Fig. 170.) In Europe the double effluve has been produced by means of two resonators connected in series as shown in Fig. 171. The effect is similar to that of the single effluve except for the greater intensity of action.

A variation of the *Tesla* Effluve, Spark, and Vacuum Treat-

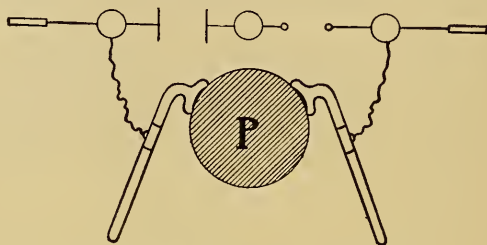

FIG. 169.—Double Vacuum Treatment.

ment, is obtained by connecting one *Tesla* Terminal to a condenser couch or *Piffard* Cushion. By this method the Multi-frequency Effect obtained by the use of the metal electrode is entirely suppressed. The same method may be employed in the use of a *Friedlander* Vacuum Chair and is of great value in a variety of conditions more especially in skin diseases covering

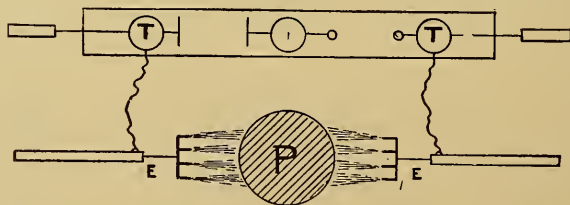

FIG. 170.—Double Effluvation from the Author's Apparatus.

large areas. The clothing should be removed from the affected part of the body during the treatment. (Fig. 172.)

No. 3.—*Multi-frequency Modalities*

As previously stated it is possible to superimpose waves of almost any form or frequency upon the oscillatory current from a *Tesla* Coil. In this manner it is possible to duplicate the

characteristics and physiological effects of the interrupted galvanic, rapid faradic, sinusoidal and static wave currents. The writer has under investigation a considerable number of Multi-frequency Effects, many of which differ from any of the

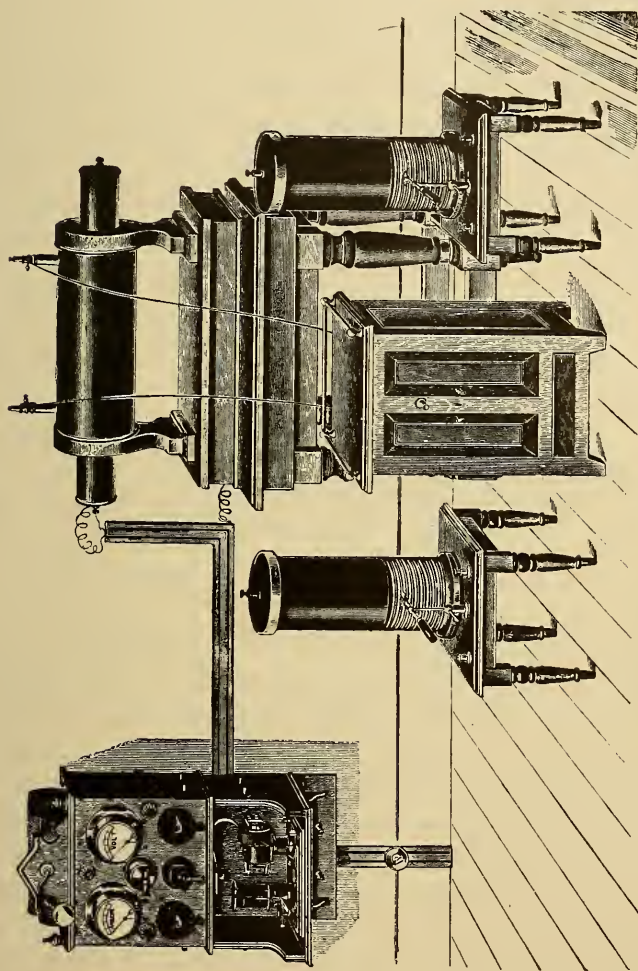

FIG. 171.—European Outfit for Double Effluvation, by Means of Two Resonators.
(Chisholm Williams.)

interrupted or alternating currents hitherto employed in the treatment of disease. In the present volume he has described only the Multi-frequency Modalities which can be readily produced by any one who possesses a modern *Tesla* Apparatus and

which have proven their therapeutic value through actual clinical application in the writer's practice.

The first of the Multi-frequency Modalities is the writer's "High-frequency Wave Current," which is produced by the interposition of an effluve between brass disks in series with the patient, who is connected by metal electrodes to the terminals of a *Tesla* Coil. Before proceeding to the further discussion of this method, it may be well to caution the operator in regard to the use of the milliamperemeter for the measurement of the intensity of Multi-frequency Currents. As the superimposed waves periodically interrupt or diminish the oscillatory stream to a degree corresponding to their own intensity, it follows that

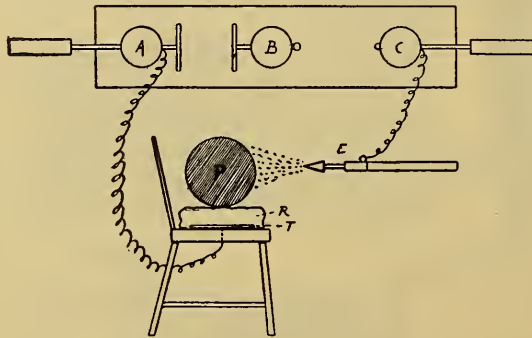

FIG. 172.—The Author's "Condenser Effluve" Treatment.

the greater the prominence of the effects from the superimposed waves, the lower will be the volume or amperage of the High-frequency Current. For example, in the above wave current, with the patient connected with a metal hand electrode to Terminal (B) of the *Tesla* Coil, with a milliamperemeter interposed, a metal electrode in the patient's other hand, being connected with the dummy, a High-frequency Current of the maximum amperage will pass to the patient so long as the brass disks are widely separated; but if the sliding rod in Terminal "A" be pushed in until an effluve appears between the disks, the patient, although experiencing a much stronger sensation, will be shown by the meter to be receiving a much smaller quantity of electrical energy. The only reliable factors for the measurement of a Multi-frequency Current are therefore the

length and nature of the air-gap, and the strength of the current employed to excite the step-up transformer of the High-frequency Apparatus. The wave current above described feels to the patient like an irregular Faradic effect, its therapeutic action, however, is quite different from either the Faradic or static induced. It is a profound stimulant to circulation, elimination and secretion, and is often administered by the writer for from one to three minutes at the termination of treatments by other High-frequency Modalities. An approximate idea of the real nature of the High-frequency Wave Current is given graphically in Fig. 173.

The "Motor Impulse Current," is the writer's term for the Multi-frequency modality obtained by the interposition of a pseudo-static spark in series with a patient connected to a *Tesla* Coil by two metallic electrodes. This method has been discussed in the preceding section, in connection with the *Tesla*

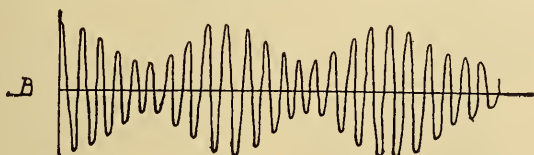

FIG. 173.—Tracing Giving a Conventional Idea of the Nature of the Author's High-frequency Wave Current.

Spark Treatment. It may also be administered by separating the disks and balls in the writer's triple terminals, connecting the patient by metal electrodes to terminal (A), and to the dummy, and then gradually pushing in the rod in Terminal (B), until intermittent sparks pass between the small balls. The intense local action of this current on the motor nerves and muscles renders it of value in the treatment of partial paralysis, chronic muscular rheumatism, etc. It is graphically represented in Fig. 174.

The "Pseudo-Faradic Current," obtained by the interposition of an extremely short spark-gap in the circuit of a patient connected to the *Tesla* Terminals by metallic electrodes, is physically the direct antithesis of the "Motor Impulse Current" above described. The latter consists of oscillations of great amplitude, periodically interrupted by groups of short oscillations, while

the Pseudo-Faradic consists mainly of short oscillations periodically interspersed with those of much greater amplitude. (See Fig. 175.)

The Pseudo-Faradic is employed in practically the same man-



FIG. 174.—Graphic Tracing Giving Theoretical Idea of the Author's Motor Impulse Current.

ner as a genuine Faradic or static induced current, but it possesses many advantages over the latter modalities owing to the High-

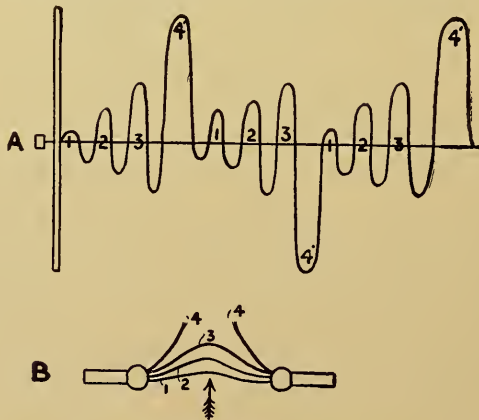

FIG. 175.—Graphic Tracing Giving Theoretical Idea of "Pseudo-faradic Current."

frequency oscillations which carry its motor waves. It is used as a substitute for massage, as an aid in the absorption of exudates resulting from fractures or sprains, and in the relief of acute rheumatism, and neuralgic pain.

No. 4.—*Hyperstatic Technic*

The *Piffard* Hyperstatic Transformer produces from its secondary coil a current of very high frequency and voltage, but possessing too low an amperage to admit of its use with the same technic as that employed in connection with a *Tesla* Apparatus of the alternating type. While it produces some effect on the general vitality, the principal value of the hyperstatic current is in the local treatment of diseases of the skin. While mild effects may be obtained by the direct application of the current from one pole of the hyperstatic (see Resonator Technic), the most efficient method of employing this apparatus is by the use of the *Tesla* Technic; the vacuum or metal point electrode being attached to one terminal, while the second terminal is connected to a metal-hand

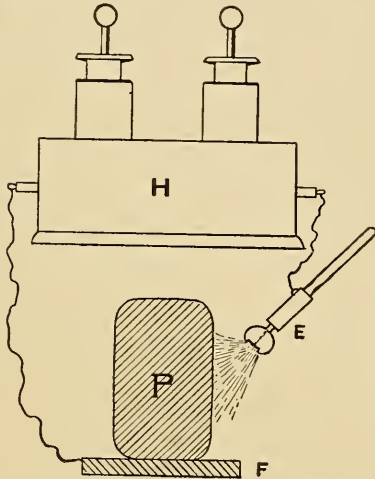

FIG. 176.—Piffard's Technic for his "Trans-resonator Effluve."

electrode, or to a metal plate which is placed upon the floor and upon which the patient stands in his stocking feet. The intensity of the Hyperstatic Current is insufficient for the production of an effluve by the usual method. For the production of this modality, a method has been devised by *Piffard*,



FIG. 177.—Piffard's Electrode for Obtaining his "Trans-resonator Effluve."

which he terms the "Trans-Resonator Technic." (Fig. 176.) The patient stands upon a metal plate, as above described, the opposite pole of the hyperstatic being connected to an electrode represented in Fig. 177, which consists of a small coil or resonator terminating in a hollow metal cup with its upper edges turned in. From the interior of this cup, an effluve discharge is produced

nearly a foot in length and fully as brilliant as that produced by an *Oudin* Resonator, although not possessing the density and fineness of the effluve from a modern *Tesla* Apparatus when employed with the condenser technic described in the preceding section.

There are many minor methods for the application of High-potential High-frequency Currents, but they offer no advantage over those above described. The indirect treatment in which the current from the resonator or *Tesla* Terminal passes through a metal electrode into the patient's body, from which it is withdrawn through the hands of the operator, applied as in an ordinary massage treatment, seems to possess certain unique possibilities, but, inasmuch as several physicians report injurious effects by the use of this method, no definite conclusion as to its real value can be deduced at the present time.

CHAPTER XXIII

HIGH-FREQUENCY CURRENTS IN THE TREATMENT OF DISEASES OF NUTRITION

THE growth and functional activity of the body depend upon the assimilation and distribution of the energy-producing organic compounds taken in in the form of food. Foods are of three classes: First, the *Proteid*, or *Nitrogenous materials*, such as albumin, peptone, casein, and gluten, which are the "Tissue Builders," strengthening broken-down cells and replacing the minute portions of the body which are being worn away and destroyed in the course of normal functional activity. Second, the Fatty substances and Carbohydrates (the latter including starches and sugars) which furnish the body with energy, and are burned up in the cells as fuel in a furnace, the products of their combustion being water and carbon dioxide; and third and lastly, the Inorganic Salts (the principal representative of this class being sodium chloride), which, though small in amount, are of extreme importance in maintaining the osmotic equilibrium and the electrical conductivity of the tissues and fluids of the body. In addition to these substances, the organism requires a constant supply of water, which is the common carrier and general solvent of the body, and a still more continuous supply of oxygen for the support of the combustion in the cells and tissues. The nutrition of the body therefore, is maintained through the *digestive system*, which breaks up and prepares the food for use, the *assimilative* and *distributive system*, including the absorbent, lymphatic and circulatory apparatus; the *oxygenating system*, including the respiratory functions of the lungs and the distributory action of the red blood corpuscles; the *metabolizing structures*, including the muscles and cellular tissues, in which the stored-up energy of the food and oxygen is liberated; and finally, the *excretory system*, comprising the sweat

glands, kidneys and the venous blood, which collects and discharges from the body the waste products of combustion and vital activity.

The disorders of nutrition may therefore be classified under the following heads:

- (A) Diseases of the Digestive System.
- (B) Diseases of the Blood and Heart.
- (C) Diseases of the Lungs.
- (D) Diseases involving Deranged Metabolism.
- (E) Diseases of the Kidneys.

A.—Diseases of the Digestive System

Gastric indigestion or dyspepsia may result from depleted nerve force, from catarrh of the stomach, from gout, and as a secondary symptom in a large number of acute and chronic diseases. When of nervous origin it is best treated by direct application of a low vacuum condenser electrode over the solar plexus; the *Tesla* Technic with a block tin electrode over the dorsal spine, being the best method for the transmission of the current. Many cases of atonic dyspepsia of nervous origin attended with dilatation and loss of sleep, are frequently met with, and are usually promptly relieved by High-frequency Treatment.

The writer has treated a number of cases of this description with excellent results. In several cases test meals of the "Ewald-Boas" type, consisting of a soft-boiled egg, roll and a cup of tea, were given prior to treatment and the result of analysis showed complete absence of pepsin, peptone and H Cl. Twenty-four hours later the meal was repeated and followed in thirty minutes by treatment of either the *Tesla* Effluve or the *Tesla* Vacuum type, applied for ten minutes, followed by five minutes of the motor wave current with block tin electrodes over the solar plexus and dorsal spine. An hour later the gastric contents were removed and analyzed, the result being an almost complete peptonization of the coagulated albumen. Daily treatment for a month effects a radical cure in the majority of instances.

Dr. Chisholm Williams has reported equally successful results in similar cases by the daily use of the resonator effluve followed by auto-condensation.

Dr. George Herschell of London has devoted considerable time to the study of the High-frequency Treatment of the diseases of the digestive tract and has obtained excellent results. He employs the *d'Arsonval* Current applied directly by means of metal electrodes in contact with the mucous membrane of the rectum and tongue respectively. *Herschell* found the above treatment of great value not only in nervous dyspepsia but in gastric ulcer, gastro-intestinal catarrh and chronic entero-colitis. (Fig. 178.)

The writer has employed a similar technic, substituting the *Tesla* Currents for those of *d'Arsonval*. In conditions of general muscular atony with obstinate constipation, the High-frequency Wave Current has given excellent results. After employing it for about five minutes with the two metal electrodes as suggested by *Herschell* (see above), a ten-minutes' treatment by the *Tesla* Effluve, spirally applied over the course of the colon should be given.

In connection with the above treatment the writer has obtained excellent results by frequently flushing the large intestine. The latter procedure may be self-administered by the patient by means of the "Internal Bath," or so-called "Cascade," of *Dr. Chas. Tyrell* of New York City. (See Fig. 179.)

In acute inflammation of any portion of the digestive tract, direct application of the low-vacuum condenser electrode in contact with the abdomen will often prove efficacious. In appendicitis, which has not reached the stage of abscess formation, application

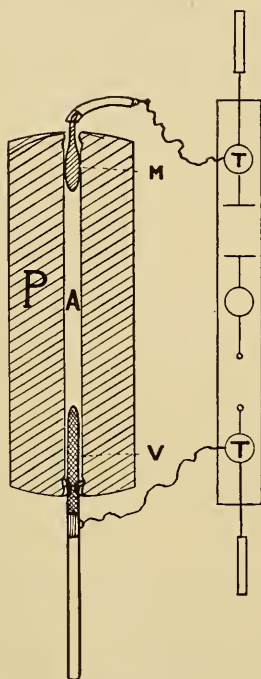

FIG. 178.—Diagram of the Author's Treatment for Diseases of the Intestinal Canal: *V*, Vacuum Electrode in Rectum. *M*, Metal Electrode in Mouth.

of the above electrode over the cæcum, supplemented by a metal rectal electrode connected to the other terminal of the coil will often abort the attack. Hemorrhoids, if acutely inflamed and congested, are usually relieved by the use of a Red-vacuum Electrode in connection with a metal plate over the solar plexus. "*Tesla Vacuum Technic.*" For chronic or sub-acute inflammation of the rectal mucosa, such as ulcers, fissures, or fistulæ, the

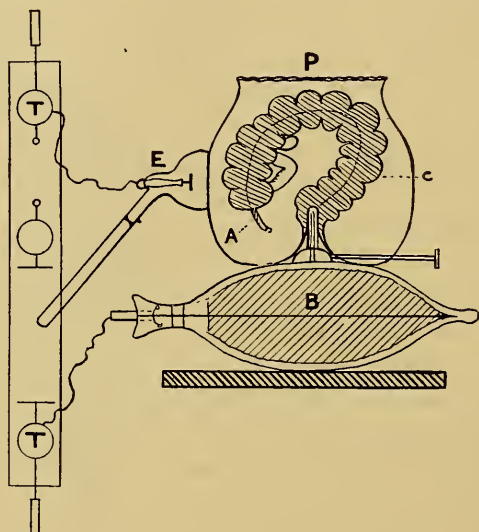

FIG. 179.—The Author's Treatment for Chronic Constipation, and for Chronic Colitis.

B, Doctor Tyrell's Cascade which Fills the Colon, *C*, with the Solution which is Connected to Tesla Terminal by way of Metal Plug of the Bag. *E*, Vacuum Condenser Electrode to be Applied to Abdomen over the Course of the Large Intestine.

same technic may be employed, substituting a White-vacuum Electrode in place of the ordinary low red variety. For chronic hemorrhoids, and in reflex disturbances resulting from the undue contraction of the sphincter ani, the writer's pseudo-Faradic technic may be employed, using the ordinary rectal dilators as electrodes, increasing their size at intervals in the course of the treatments. The opposite electrode is the usual block tin plate over the solar plexus.

B.—Diseases of the Blood and Heart

The distribution of nutrition by the blood stream depends upon the constant circulation of the latter. Any interference with the movement of the blood—results in local or general disturbance of cell nutrition and growth. The circulation is maintained by two distinct mechanical systems; the heart, which is a powerful double pump of muscular fibers, which forces the blood with its load of fresh food and oxygen, through the arteries to all parts of the body; and secondly, the *vaso-motor system*, which collects the blood from the cells and tissues of the body and sends it with its load of waste products and gases, resulting from cell combustion, through the veins, back to the lungs and heart. The heart sends the blood out in periodic waves or pulses, its rhythmic motion being produced by a constant supply of electrical oscillations generated in the cardiac ganglia in the sympathetic nervous system; the movements of the heart being regulated or governed by a second variety of nerve force transmitted through the pneumogastric nerve. Stimulation of the cardiac ganglia increases the strength and vigor of the pulsations. If the pneumogastric nerve were paralyzed, the pulse would become more rapid and the heart would race like an engine without a governor. The vaso-motor mechanism is not confined to a single organ, but consists of thousands of little tubular pumps which surround the smaller veins, and which force the blood through the latter by a series of longitudinal waves or contractions produced by a network of conducting filaments called the vaso-motor nerves, which form a part of the sympathetic nervous system. The waves which force the blood through the veins result from the harmonious action of two sets of muscles, each of which has its special set of nerves. The first of these sets of muscles is called the vaso-dilators. The second the vaso-constrictors. Paralysis of the vaso-motor system, if complete, would cause death in a very few minutes, as the blood being unable to return to the heart would burst the walls of the capillaries and diffuse through the superficial tissues. Partial vaso-motor paralysis causes a backing up of the blood in the

smaller blood vessels, which is called Passive Congestion. Increase in strength or frequency of the heart pulsations, causes a still more marked engorgement of the smaller arteries and capillaries, which is termed Active Congestion. Disturbance of the equilibrium between the cardiac and vaso-motor systems, may cause a concentration of the blood in the larger veins and arteries with a diminution in the contents of the remote peripheral vessels. This condition involves pallor and coldness of the surface of the body, with a tendency to chills, thereby lowering the vital resistance, and predisposing the tissues to bacterial infection. When the latter event occurs, we say we have "caught a cold." Fully nine-tenths of our acute diseases result primarily from the above sequence of effects; the initial anæmia of the superficial tissues being in most cases due to depletion or exhaustion of the nervous energy of the great centers which supply the vaso-motor system.

There is no agent known to the profession which produces such immediate and direct effects upon the vaso-motor system as the *Tesla* High-frequency Current; in the condition above described, the surface anæmia and chilliness give place to a healthy warmth and glow within five minutes after the application of the *Tesla* Current. Even where serious disturbance of the vaso-motor system is present, such as in the initial chill of lobar pneumonia, prompt and vigorous use of the *Tesla* Current either by the effluve, or wave current technic, will if persistently applied, destroy the toxæmia, break up the superficial chill and fever and actually abort the disease; the patient breaking out into a profuse perspiration, and the pulmonary congestion changing its character so that a mild catarrhal inflammation replaces the virulent pneumonic infection.

In secondary anæmia and chlorosis, general High-frequency Treatment is of great value in stimulating the regenerative forces to the production of new blood cells, and increasing the oxygen-carrying power of the individual corpuscles. *D'Arsonval* Auto-condensation with *Tesla* Low-vacuum Treatment over the spine and solar plexus, will usually bring about a progressive increase in the strength and activity of the vital functions.

Diseases of the blood-vessels are in the majority of cases

amenable to treatment by currents of high frequency. Weakness in the walls of the veins or arteries except those of traumatic origin are corrected and strengthened by the *Tesla* Currents, which not only facilitate the access of the natural regenerative forces, such as the leucocytes and the elements of the blood and lymph, but by their stimulation of the vaso-motor system, they relieve the weakened vessels of undue pressure and tension, and facilitate the return of normal elasticity. In this manner the High-frequency Currents produce beneficial results in simple and rheumatic purpura, varicose veins, phlebitis, aneurism, and arteriosclerosis.¹ General treatment by use of the vacuum chair, or Low Red-vacuum Electrode Treatment over the solar plexus with the condenser couch, are best adapted to the above conditions. Local treatment over the weakened vessels is not recommended nor should the Multi-frequency Methods be employed.

In organic heart disease the *Tesla* Currents are often of great value in assisting nature to establish compensation; in the later stages, when compensation has been finally destroyed by the dilatation of the affected muscle, the current may be used as a palliative treatment through its action on the vaso-motor system and its tendency to disperse dropsical effusions. The Red-vacuum Electrode should be employed by the monopolar indirect method; or better still, the vacuum condenser chair may be used instead of the metal electrode; the local application of the vacuum tube in either of the above methods, should be over the cervical vertebræ and afterward over the solar plexus.

D'Arsonval and other European authorities have reported a number of cures of organic heart disease in which beneficial results were obtained by treatment in the auto-conduction cage.

C.—Diseases of the Respiratory Tract

In this climate one of the most common and annoying affections which the physician is called upon to relieve is the ordinary acute coryza, a catarrhal inflammation of the nasal passages, resulting from a mixed infection by pyogenic streptococci and

¹Since writing the above a number of cases of Arteriosclerosis have been reported by *d'Arsonval* and his colleagues, and successfully treated by auto-conduction.

staphylococci; the primary infection, although not in itself a serious matter, so lowers the vital resistance of the entire body, particularly in the vicinity of the affected mucous surfaces, as to predispose the patient to other more serious infections, such as acute bronchitis, pneumonia, diphtheria and epidemic influenza. If applied in the early stages of the attack attended with symptoms of disturbed equilibrium in the blood-vessels, such as congestion of the nasal mucosa with a profuse watery discharge, chilliness, alternating with fever, the *Tesla* Currents will usually give prompt relief. *Tesla* Vacuum Treatment with a metal electrode over the solar plexus and a slender Red-vacuum Electrode inserted in the nostrils will promptly relieve the congestion and in many instances completely abort acute coryza; the treatments should not be discontinued with the disappearance of the symptoms; ten-minute treatments given at intervals of three hours so long as the acute symptoms remain should be given daily for a week after the attack has apparently subsided. The latter precaution will often save the patient from a serious secondary infection resulting from the lowered vital resistance. It is well to terminate each seance with a five-minute application of the High-frequency Wave Current applied by means of metal hand electrodes, or better still, with block tin electrodes applied respectively to the base of the brain and over the solar plexus.

Treatment of the various acute diseases of the respiratory tract should be given with the above-described technic, a vacuum electrode of appropriate form and size being substituted for the nasal electrodes.

In connection with his recently perfected apparatus for the treatment of pulmonary tuberculosis (See Fig. 151, Chap. XIX), the writer has devised a combined inhaler and double-vacuum electrode by means of which all varieties of acute and chronic diseases of the respiratory tract may be successfully treated. This device is shown in figure 180; it is made in two forms, for use in acute and chronic diseases, the first being of the Low Red-, the second of the White-Vacuum type. If desired, these electrodes may be used independently of the ozonized oxygen apparatus, the two bulb-shaped cavities being loosely filled with

cotton wet with some volatile antiseptic such as pineoleum, formaldehyde, or guaiacol. This device is used in place of the single nasal electrode previously described.

Pulmonary Tuberculosis

Prominent authorities in all parts of the world have reported cases of pulmonary tuberculosis successfully treated by the application of High-frequency Currents. Among the European

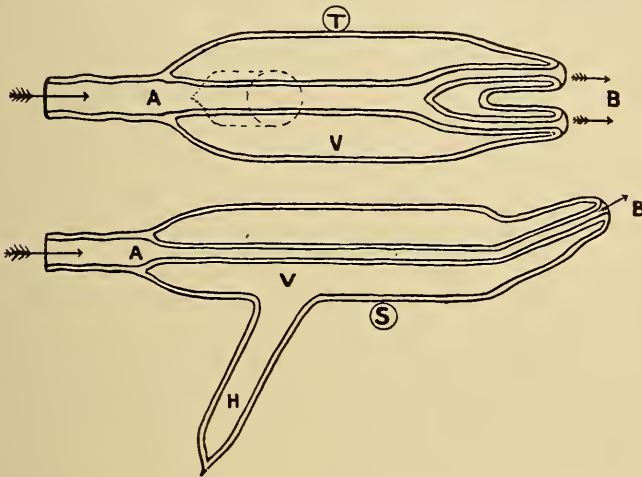

FIG. 180.—Tubulated Vacuum Electrode for Inhalation Treatment.

A, Tube, or Air Channel. B, Double-end for Insertion in Nostrils. V, Vacuum Chamber. H, Stem to Fit in Insulating Handle. T, Top View. S, Side View.

specialists, *d'Arsonval* Auto-conduction and condensation have been employed, supplemented by an effluve treatment from an *Oudin* Resonator applied directly over the areas of pulmonary infection.

The following description is quoted from *Dr. Chisholm Williams'* admirable little treatise, "High-frequency Currents in the Treatment of Some Diseases" (published by the *Rebman Co.* of New York and London):

"In July, 1901, the author read a paper on 'The Treatment of Phthisis by Electrical Currents of high frequency and high potential,' before the British Medical Association at Cheltenham,

and observed that forty-three consecutive cases were treated. There is reason to believe that the currents act in these cases in the following manner:

“Firstly, on the tubercle bacilli themselves by making them pursue the same course as if they were under the X-Rays. According to the experiments of *Drs. Forbes Ross and Norris Wolfenden*, in their paper on the ‘Effects produced in Cultures of Tubercle Bacilli by Exposure to the Influence of an X-Ray Tube’ (*Archives of the Roentgen Ray*, August, 1900), they observe that the bacilli rapidly increase in numbers and have a tendency to form clumps, then get small in numbers and shape, and take the microscopical stains very readily, but are pale in color. They say, in conclusion, ‘There is not the smallest doubt that X-Rays stimulate them to excessive overgrowth, and only affect them adversely by attenuation from overgrowth.’

“In my experience much the same process goes on under the High-frequency Treatment. The tubercle bacilli, which are usually present in fair numbers, quickly begin to increase, and after a few applications are greatly increased; they soon, however, form clumps and get misshapen, short, and stumpy, and generally curved, and take the stain far more readily than before. After a time they begin to decrease in numbers, and later, when the patient is obviously getting better in every respect, they may cease entirely, and may appear in the sputum after weeks of absence.

“Secondly, the effects of the currents of high frequency on the individual cells of the body. We judge this by the appetite and digestive powers increasing, and the patient’s gain in weight. The general improvement of the body cells probably makes them more resistant to the inroads of the tubercle bacilli; but whether the lowering of the tubercle’s vitality, or a raising of the body-cells’ resisting power, or a combination of both is at work, for our purpose matters little. In the majority of these cases the leucocytes were greatly increased in numbers during a course of the treatment.

“In some cases the temperature is the first thing affected. Presuming that the daily variation has been about three degrees between the evening tide and the morning fall, either after the

first application or, at most, after the third (consecutive days), the evening rise should be higher and the morning fall less. On examining the affected area, we find the physical signs at first increased; thus more *coarse râles* of louder and of a greater number could be found; the expectoration becomes larger in amount and the cough more frequent and easier. After a few applications generally when given locally, the patient often complains of pain or an uncomfortable feeling over the affected part. This as a rule, passes off after a couple of weeks' treatment, and is never severe if we pay due attention to the length of time and number of applications. A slight amount of pain over the affected area in severe cases is often noted from the general methods.

"When the temperature has been raised by the treatment, the patient, of course, may feel rather worse—*i.e.*, lassitude, and the sweats on the fall of the fever are sometimes large in amount; also during this period the body weight may decrease, or, at all events, remain stationary. I found this in many cases where the fever increased; and in spite of the patient taking presumably a much more nutritious diet, still a slight weekly loss was observed. Some cases will react to the influence of the High-frequency Currents within twenty-four hours; others may take a few days. The more severe the case the more quickly does the reaction take place. However much the temperature rises, it will generally be found down to or at the patient's usual normal within forty-eight hours, so that the dose can be readily regulated, and the patient only given as much as he can comfortably bear. When the patient can be exposed to the currents for over a half an hour daily for one week, and it is found that during the whole period the temperature remains steady at normal and subnormal, we may safely predict that the disease is, to say the least of it, arrested. With all these patients the milliamperemeter registered from 150 to 250 milliamperes, seldom less; latterly an average of 350 milliamperes has been used, and the time five minutes."

"The chart shown is a fairly typical temperature in a severe case. For the next three weeks it never rose over ninety degrees; for the following eight weeks it never rose over normal, and generally

subnormal; then daily observations were stopped. The weight increased one pound during the first week, lost one pound for the next two weeks, then steadily gained one to two pounds for the following eight weeks. During the fourteenth week of treatment from the commencement of 'high frequency' the patient "put on" three and one-half pounds. Her weight (in her clothes) was six stone and her height five feet one inch. During the fourteen weeks' treatment she gained one stone and four and one-fourth pounds. Two months after, with no treatment, she weighed (in clothes) seven stone thirteen pounds, which she has maintained for the last twelve months. The applications were fifty in number, and varied in dose from five to twenty minutes. After the third week twenty-minute doses were given on the average twice a week. In March, 1901, twelve months after, five applications of thirty minutes' duration, given on five consecutive days, could only raise the temperature to 99° in the evening and 98.2° in the morning. Now one finds that the average dose is ten minutes with the milliamperemeter registering 300 to 400 milliamperes."

"Forty cases in all were treated in London, which can at present hardly be considered as a first-class health resort, but I am strongly of opinion that the application of High-frequency Electrical Currents in sanatoria and like institutions will greatly swell the number of so-called cures. It is a remedy that should only be administered by medical men, as it needs as much care as any other therapeutic agent."

"Further information of the original forty-three cases: Three have died; of the rest, thirty-two have had no treatment of any kind whatever for over eighteen months. Eight cases had on an average two months' treatment each since that time. This year none of them have needed treatment. The majority, who were workers, are performing their usual duties. The three deaths were due to pneumonia, tuberculosis kidney, and lardaceous disease."

"Briefly, those patients received from ten to twenty minutes' auto-condensation. Eleven of the earlier cases were treated to the effluve locally over the bared affected area, the operator's unemployed hand being placed in contact with the back of the

chest; but owing to lack of time, etc., this latter method was abandoned. Other workers have experienced such good results that in some cases it would be well to employ general and local means."

"Under this treatment they lost their cough and expectoration. The tubercle bacilli disappeared;—but in some a few could be found months after all treatment had been stopped, yet they seemed in good health. Sometimes their sputum would be without tubercle for months, then a few would reappear for a few weeks, and then, without treatment, disappear again. The bodily weight increased in favorable cases as much as a pound a week."

"When many hundreds of these phthisical patients have been subjected to this method we shall be in a position to judge of its merits and compare it with the 'open-air cure,' which at present has not shown such a good percentage of 'arrests.' In my opinion, as a valuable adjunct to a sanatorium, it should afford every material assistance, even in the more severe cases that do not usually gain admittance."

Dr. H. Thielle reports a series of cases of pulmonary tuberculosis treated with currents of high frequency and high potential.¹

"Out of twenty-six tubercular patients treated, thirteen are cured, nine of these were hard-working laborers; four patients, who are on the road to recovery, are still under treatment; seven incurables were treated for the sake of completing his study and observations."

The author concludes as follows:

"The High-frequency Effluve fills the therapeutic indication demanded by clinical experience; it has an evident action upon the chemistry of respiration; increases the respiratory capacity; diminishes the frequency of respiration, the production of carbon dioxide, the total amount of oxygen consumed and absorbed by the patient; as a result, raises the coefficient of oxidation and lowers the coefficient of absorption.

"This action is not temporary; it continues even after the

¹ *Bulletin Officiel de la Société Française d'Électro-Thérapie*, November, 1905.

cessation of the treatment. When during a course of treatment, we notice from month to month increased respiratory exchanges and a diminished respiratory capacity, we will always find the cause in the existence of one of the following complications: Coryza, catarrh (usually severe), influenza, syphilis, physical or intellectual overwork, prolonged walking, mental depression, etc.

“In two cases with fibrous change (Cases 7 and 8) the respiratory exchanges remain slightly above normal, and the treatment prolonged several months, even during one year, did not produce any change.

“The High-frequency Effluve increases the acidity of the urine, raises or lowers, depending upon the case, the products of nitrogenous combustion of the body, and arrests the excessive loss of mineral salts, which is a constant symptom of a tuberculous state.

“The modality produces the following changes in the composition of the blood: The amount of hemoglobin and the number of red blood cells are increased, and there is usually a decrease of white cells. The tissues being remineralized, the leucocytes obtain the mineral elements of which they are deprived in the tuberculous subject, and, therefore, regain their activity and power; the defenders of the organism remain in fewer numbers but stronger, quality replacing quantity. The number of lymphocytes, those young cells which perform an important part in the nutrition, repair, and cicatrization of the tissues, is increased.

“The general health of the patient in all stages of the disease improves under the influence of the effluve; respiration is easier, inspiration deeper. All our patients experience a cool sensation, due to the penetration of air in the lungs, especially the one which is the most involved. This cool sensation disappears about the time of the fifteenth application.

“The oppression and the dyspnoea disappear after fifteen or twenty seances, sometimes earlier, rarely later.

“The cough is modified from the start; it diminishes progressively and disappears in some of the cases during the first month, in others during the second or third month; but the

coughing spells rarely occur, except at night and in the morning, sometimes after meals, and they do not last as long and are not as painful.

“The effluve occasionally provokes a dry cough, even a slight dyspnoea; the cough and dyspnoea are caused by the direct application of the ozone which is liberated by the apparatus, but there is a gradual tolerance. The expectoration is easier, less frequent, less abundant, from purulent it becomes mucous and ceases, as a rule, before the end of the treatment.

“The bacilli disappear sometime during the early months, sometimes at the end of the treatment; we have never seen it reappear in any of our cases which were cured. Excepting temporarily in Case 2, after a severe attack of grippe, accompanied with high fever.

“We attach no importance to the quantity of bacilli found on the microscopic field; this quantity being very variable. It is admitted that the expectoration on rising contains a larger number; after this morning expectoration which cleanses the bronchi, the following sputa contain less bacilli and often none at all. The appearance of the bacilli in the sputum is a late symptom. Tuberculosis begins the moment that the bacilli penetrate a favorable soil; this invasion is slow, insidious, and formerly escaped all our investigations; the study of the chemistry of respiration permits us to detect tuberculosis from its inception, and even to recognize the predisposing soil; when the enemy is known, it is easy to fight him and to render, by an appropriate treatment, the systems of those who are predisposed immune against the disease.

“The sleep is better from the first night; the sweats diminish and cease when about fifteen applications have been made.

“The appetite returns after the first few seances, increases after the tenth or so, and gets better and better. The digestion is good.

“The strength returns and increases progressively during the course of treatment, nearly all our patients were able to continue their daily labors, a point of the utmost importance to them since they depended upon their labors for a living and often for the support of large families.

"The weight varies according to the patient; increasing very little in some; a great deal in others. Again it was subject to variations, depending upon the diet, fatigue, etc., variations which are also observed in healthy individuals. All our cured cases have maintained a weight which is greater than that before the treatment.

"When the patients were weighed, they had taken no food in several hours and wore the simplest and lightest garments.

"In phthisical cases, with fever, as well as those with softening cavities, the effluve always increases, temporarily the respiratory capacity and diminishes the frequency of the respiration. The lowering of the respiratory rate occurs from the first month, but later remains stationary, differing thus from the marked gradual decrease observed in the tubercular patients, which are curable; although the treatment was extended over six months and in some instances over one year, we have not been able to restore to the normal rate the respirations, which after a lapse of time more or less prolonged, or after cessation of the treatment, begin again to rise.

"The general health in the patients belonging to these various categories is good or seems good; the appetite returns, the weight increases, the strength is regained, work and exercise are easier, the night sweats disappear, the nights are good. The oppression ceases momentarily, the cough is less frequent and painful, the physical characteristics of the expectorations are modified. It is less purulent, less abundant, easier, and becomes almost negligible. The mental condition is better; the patients are hopeful for a cure; the effluve has caused an illusionary cure, but not a real one, and after a varying lapse of time, the disease resumes its destructive course.

"The organism is vanquished, the bacillus of *Koch* continues its work of destruction, and the fatal termination is only a question of time.

"Without the biological examinations, these temporary improvements and apparent restorations to health, may have given us the illusion of success.

"If we have not been able to have, even for one instant, the illusion of curing these patients, we have at least given them

that illusion, and we have also, thanks to our modality, afforded them an immense relief, since in nearly all the oppression, cough, expectoration, sweats and weakness only reappeared much later, during the last stages of the disease."

As the great majority of physicians who have employed High-frequency Currents in their practice have used the apparatus of *Oudin* and *d'Arsonval*, it is natural that most of the reported cases of tuberculosis have been treated by currents of solenoid and resonator types. Although employed in the writer's own practice for over ten years, apparatus and technic for the production and therapeutic application of the *Tesla* Currents have been available for general use only within the last year or two. It is obvious therefore, that any great number of clinical reports illustrating the value of *Tesla* Treatments are not as yet obtainable from outside sources. From the writer's own experience however, and from a theoretical standpoint, there is every reason to believe that in the modern *Tesla* Apparatus we have a source of electrical modalities which not only possess all of the qualifications which have made the resonator and solenoid currents of such great value in the treatment of tuberculosis, but which possess distinctive therapeutic advantages which cannot be duplicated by currents produced in any other manner. The general effects of auto-condensation and the local results of effluve treatment have demonstrated the importance of these methods; but in the *Tesla* Current applied by the writer's bipolar methods, we simultaneously produce effluve and other local effects, more intense and penetrating than the resonator discharge, and general vitalizing effects which cannot be reproduced by the lower potential currents of *d'Arsonval*. It should be distinctly understood that the writer is not disparaging or questioning the therapeutic value of the latter currents; on the contrary, it is his practice to administer occasional *d'Arsonval* Treatments to patients undergoing *Tesla* Treatment for pulmonary tuberculosis. The increase in cell combustion, metabolism and elimination, produced by the *d'Arsonval* Currents are not produced in the same degree by the High-potential *Tesla* Currents which act more especially on the vaso-motor and trophic systems. The *d'Arsonval* Current obtained from the

primary coil of the modern *Tesla* Apparatus is really more efficient than if produced by a solenoid of the European type.

The remarkable possibilities of the *Tesla* Treatment in pulmonary tuberculosis, even when the current is applied under the most unfavorable conditions is well illustrated in the report of a case treated by the writer some five years ago. A young man of sedentary habits, whose occupation made it necessary for him to work for the greater part of each night, broke down completely as a result of overwork. An attack of nervous exhaustion left him with a greatly depleted vital resistance, and not unnaturally, he contracted pulmonary tuberculosis. Temporary rest and change of climate were of little avail and he was ultimately sent to a celebrated mountain resort noted for its open-air treatment of tuberculosis. The disease was progressing rapidly to a fatal termination when the writer was asked to administer High-frequency Treatment. A special apparatus was constructed and installed in the patient's room at the resort above-mentioned. When first seen by the writer the patient was apparently nearing the final stage of the disease. His physician, one of the principal authorities of this country on tuberculosis and its treatment, informed the writer that infection had extended to the intestinal canal, and probably to the entire organism, and stated that unless a miracle should intervene, the patient would die in from one to three months. He expressed courteous but pronounced skepticism regarding the possibility of benefiting the patient by High-frequency Currents, or any other therapeutic agent, while his assistant who personally attended the patient, expressed an equally marked skepticism but *without the courtesy*. The writer installed the apparatus, administered the first treatment, and instructed the nurse as to daily treatments which were to be given. The first effect of the current was to break up the stasis in the more healthy portion of the lung tissue, and to aid nature in throwing off the accumulated poisons; as a natural result, expectoration increased, more bacilli appeared in the sputum, night sweats became more profuse and the fever higher. The beneficence of these effects, however, were evidenced by the fact that despite the great drain on the vital energies, comparatively little reaction

or prostration followed. The physician in attendance took advantage of the increase in the severity of the symptoms to inform the patient that the treatment was killing him, and after three weeks of daily treatment the administration of the current was discontinued. The elimination of the accumulated poisons gave rise to the above-mentioned symptoms which masked the real benefit produced by the treatment. On the cessation of the latter the increase in vitality and recuperative power at once manifested itself and two weeks later the patient was driven out for the first time in months. So far from admitting the results of the treatment, the patient's physician actually ascribed his improvement to the fact that the electricity *had been discontinued*; and this, despite the progressive advance of the disease during the six months prior to the writer's visit! Four months after the above events, the patient was taken to California; apparently became completely restored to health and lived an active outdoor life for two years, at the end of which period he succumbed to pneumonia resulting from excessive exertion and exposure.

Other cases of tuberculosis treated by the writer have shown progressive improvement, almost from the first application of the *Tesla* Currents; three cases were for the most part in the earlier stages, before secondary streptococcus infection had appeared. Technic in these was generally confined to the usual *Tesla* Vacuum Treatment, the glass electrode being moved over the lungs and spine, and the metal electrode applied over the solar plexus.

In cases treated more recently the double-vacuum technic has been employed; White-vacuum Electrodes of the condenser type being applied over each lung; this has been varied by the occasional use of the *Tesla* Effluve and *d'Arsonval* Auto-condensation.

The reports received from other physicians who have employed the writer's apparatus and technic in the treatment of pulmonary tuberculosis, amply confirm his own conclusions regarding the importance of the *Tesla* Currents in the treatment of the above disease.

Excellent results have been obtained in the treatment of

tubercular patients by inhalations of ozone, even from the crude product obtained from the passage of air across a High-potential Brush Discharge in a glass vessel. Great benefit has followed the use of pure oxygen in similar cases, also of aromatic oils, and volatile antiseptics administered by means of a nebulizer.

The writer's recently perfected apparatus and technic for the scientific treatment of tuberculosis by a simultaneous administration of the *Tesla* High-frequency Currents, pure ozonized oxygen, and ionized aromatic vapors, has been fully described in the Chapter on the "Therapeutic Use of Ozone."¹

D.—Diseases Involving Deranged Metabolism

Under the above heading may be grouped a number of general diseases of obscure origin but distinctive pathological effects. We have, for example, *diabetes* which involves the improper metabolism of the carbohydrates, characterized by the presence of sugar in the blood and urine; *gout*, resulting from the imperfect combustion of cell *débris*, and other nitrogenous waste products, characterized by the presence in the tissues of the partially oxidized, insoluble *uric acid*, instead of the completely oxidized soluble *urea*, which is produced in healthy individuals. Uric acid combines with the soda and lime of the tissues forming sharp crystals which collect in and around the joints, constituting the well-known "chalky" or "gouty" deposits. *Obesity* is a form of mal-nutrition in which fatty foods, instead of being oxidized and giving up their energy to the vital functions, collect in the cells of the subcutaneous areolar tissue forming the adipose layers which are commonly termed "fat."

In addition to the above diseases there are many conditions in which all the metabolic processes are diminished; these secondary conditions result from the constant drain on the vital forces in the course of acute and chronic infectious disease. The depletion of the sympathetic nervous energy causes a lack of vaso-motor power, weakened heart action and insufficient respiration. As a result we have a wasting of the tissues from a lack of nutrition and oxygen, an accumulation of waste products, causing rheuma-

¹ Since the completion of this manuscript several advanced cases of tuberculosis have been apparently cured after three months treatment by the combined High-frequency and Inhalation method above mentioned.

tism in the muscles and joints, and insomnia and irritability from the deposits in the brain and nerves; chilliness of the surface of the body, with cold and numbness of the extremities are characteristic symptoms.

Although differing in their general symptoms, the various diseases above-described are closely allied, in that they all result from some local or general interference with the nutritive and metabolic processes of the body. This fact alone would suggest the probable value of High-frequency Treatment in the above conditions, and clinical evidence from a variety of sources offers ample confirmation of this conclusion. The influence of the *d'Arsonval* Currents is beneficial in all the above diseases and daily treatment with the cage or condenser couch should be given if possible, in addition to the local application of the resonator or *Tesla* Currents. General treatment by the *Tesla* Wave Current or the *Tesla* Effluve, applied over the spine and solar plexus, should be employed in the treatment of the above conditions, unless complicated by organic heart disease. Local manifestations, such as the skin lesions of diabetes, and the local pain of rheumatism and gout, require *Tesla* Vacuum Treatment, the electrode being applied over the clothing if acute pain be present. Gouty joints in the chronic stage are benefited by *Tesla* Sparks and direct application of the *d'Arsonval* Current. Where stiffness in either muscles or joints occur, the Pseudo-Faradic or Motor Impulse current may be used in addition to the above methods. It is to be understood that the High-frequency Treatment of the above diseases should be accompanied by hygienic and dietetic measures, and medical treatment if desired. One great advantage of High-frequency Treatment is the absolute impossibility of its producing any effects which would interfere with the administration or action of any other form of therapeutic agent. On the contrary, the *d'Arsonval* and *Tesla* Currents, by their action on the circulation and their stimulation of vital function, *actually increase* the therapeutic efficiency of all varieties of medicinal agents.

E.—Diseases of the Excretory Apparatus

Diseases of the bladder and kidneys result as a rule from the continued irritation of urates, uric acid, calcium oxalate and other products of deranged metabolism and incomplete tissue combustion. In addition to the above causes, diseases of the kidneys may result from inequalities in the blood pressure, occurring as secondary effects of organic heart disease, or toxic infections. When due to deranged metabolism, High-frequency Treatment, as described in the preceding section, will usually restore the kidneys to a normal condition by removal of the exciting cause. If renal congestion of an active type occurs in the course of other diseases, it may be usually relieved by *Tesla* Treatment with Red-vacuum Condenser Electrode, and a metal plate over the solar plexus; if fever is present it should be treated by the technic described in connection with acute infectious disease. Passive renal congestion is usually of a chronic or sub-acute type, and should be treated by the local use of a White-vacuum Condenser Electrode, with the *Tesla* Technic as above. In organic disease of the kidneys, with actual degeneration of the tubular epithelium, the *Tesla* Currents are of the greatest value. Cases of acute and chronic nephritis, both the interstitial and parenchymatous varieties, have been successfully treated in the writer's practice, by the application of the *Tesla* Currents to the lumbar region, the effluve and vacuum electrodes being used, each for ten minutes; followed by direct application of *d'Arsonval* Current by means of sponge electrodes. General treatment by the *Tesla* Wave Current, used alternately with *d'Arsonval* Auto-condensation should follow the local direct treatment just described.

Renal colic may be frequently relieved, and the passage of the calculus through the ureter facilitated by pseudo-static sparks applied anteriorly or posteriorly according to the position of the stone. The *Tesla* Wave Current or Pseudo-Faradic are also of value in this condition, an olive-tipped electrode with insulated stem being inserted into the bladder and a block tin or metal disk electrode being applied to the lumbar region over the affected kidney.

In septic infection of the urinary tract such as pyelitis, pyelonephrosis and cystitis, the metal olive-tipped electrode is inserted in the bladder as above, connected to the terminal of the *Tesla* Coil, while a White-vacuum Condenser Electrode connected to the center terminal is applied to the surface over the kidney or bladder.¹ In acute cystitis of the catarrhal type, the same technic is employed substituting a *Red-vacuum* Electrode for the *White*. In acute cystitis complicating a gonorrhoeal urethritis, a *Red-vacuum* Electrode, shaped like an ordinary sound, is inserted through the urethra into the bladder, and connected to the center terminal, the *Red-vacuum* Condenser Electrode being connected to Terminal *B* and applied to the surface over the bladder. Persistent gleet may be permanently cured by frequent treatments with similar technic, but the urethral electrode should be exhausted to a white vacuum in place of the low red tube, used with acute inflammation.

Urethral stricture may be relieved in many cases by the use of the Pseudo-static or *Tesla* Wave Current, an insulated olive-tipped electrode being in contact with the fibrous ring of the stricture, and the second electrode, consisting of a metal plate, applied over the solar plexus. Strictures of the more aggravated type are best treated by negative electrolysis with the galvanic current, each sitting being terminated by a five-minute *Tesla* Treatment with a Low *Red-vacuum* Electrode in the urethra.

Functional impotence from excesses, or of nervous reflex origin yields readily to High-frequency Treatment. The current is applied in the form of the *Tesla* Effluve over the lumbar and sacral spine, the metal electrode being over the solar plexus. For the psychic effect on the patient, it is well to terminate each treatment with a short application of the *Red-vacuum* Electrode over the testicles and perineal region.

¹ See "Tesla vacuum Technique."

CHAPTER XXIV

THE TREATMENT OF DISEASES OF THE NERVOUS SYSTEM BY HIGH-FREQUENCY CURRENTS

THE physiological action of the various High-frequency Modalities on the different types of nerves has been more or less generally explained in the preceding Chapters.

The *d'Arsonval* Current does not affect the nerves directly, but it is of value in restoring defective metabolism resulting from the depletion of the nervous energy of the body and may be used locally in connection with the *Tesla* Currents for the purpose of re-establishing cellular growth and nutrition in cases of muscular atrophy or incipient degeneration of the nerve fibers. The general rules for the application of High-frequency Currents in diseases of the nervous system have never been definitely formulated, but the results obtained by the writer during his ten years' experience in High-frequency Therapeutics seemed to justify the following tentative conclusions:

Diseases of the nervous system may be divided into certain classes, each of which corresponds to definite methods of treatment. For example, diseases of the *motor nerves*, involving loss of muscular power, are treated by White-vacuum Condenser Electrodes over the spine, and peripherally, by some variety of Multi-frequency Current; the *Tesla* Effluve being properly included under the latter head.

The second group of diseases comprises the affections of the *sensory nerves*, such as neuralgia, sensory paralysis, lumbago, etc., which should be treated by the effluve from a *Tesla* Coil in connection with a condenser couch, the White-vacuum Electrode by the indirect or *Tesla* Method, sparks of the Pseudo-static type, and labile applications of the *d'Arsonval* Current.

In the third class we have diseases involving loss of trophic influence, including the various skin diseases of nervous origin

and constitutional tendencies, which predispose to infections such as carbuncles, boils, sties, etc. These conditions are locally benefited by the direct Effluve and indirect Vacuum treatment; also double vacuum treatment by means of a Red and White-vacuum Condenser Electrodes. The secondary local infections which result from the trophic depletion, such as carbuncles and furuncles, may be checked in their course by the use of the *Tesla* Arc or High-frequency Cautey.

In the next class we have the various types of neuritis which involve the inflammation and sometimes partial degeneration of certain nerves. These conditions should be treated by local application of the *d'Arsonval* Currents and by the Red-vacuum Electrode applied by the monopolar indirect method over the affected area. Paralysis, resulting from neuritis in a motor nerve, should be treated peripherally by the methods enumerated under "Motor Affections." Chronic neuritis with pain and loss of power in the muscles, such as sciatica, should be treated by a White-vacuum Electrode connected for the *Tesla* Technic and applied along the course of the nerve with intermittent contact, so as to produce sparks from one-half to one inch long, between the end of the electrode and the body. This Vacuum spark treatment has also given good results in cases of tri-facial neuralgia, torticollis, and similar affections. Multi-frequency Currents, while of use in treating muscles partially paralyzed as the result of neuritis, should never be used over the course of the inflamed nerve.

The next group includes diseases involving degeneration of some portion of the spinal cord, or of the spinal nerve roots. Under this head may be mentioned locomotor ataxia, infantile paralysis, paraplegia, lateral sclerosis, etc.

Peripheral affections resulting from these diseases are treated in accordance with the above rules, irrespective of their central origin. The lesions in the spine, however, are treated much in the same manner as cases of chronic neuritis. Local *d'Arsonval* Treatment is employed with a stable electrode over the solar plexus, and a labile electrode over the spine. Hemiplegia, paralysis agitans, and senile dementia, involve hemorrhage or degeneration in the brain, and are treated more or less success-

fully by application of Vacuum condenser electrodes usually of the White type applied to the base of the brain, or over the affected portion of the cortex. *Tesla* Technic is employed with a metal electrode over the solar plexus. In atrophy or degeneration affecting the optic tract, or the medulla, the same technic is employed, but the metal electrode is placed in the mouth of the patient. Local or constitutional conditions resulting from the above diseases should be treated by the methods described under the various headings. Migraine, congestive, or nervous headaches, readily yield to treatment by the Red-vacuum electrode over the solar plexus. Excellent results have also been obtained in the treatment of epilepsy by the High-frequency Currents; the technic is similar to that employed in other brain affections.

The next and last group of nervous diseases includes the so-called "Functional Neuroses," such as hysteria, chorea, neurasthenia, etc. General treatment of these conditions involves the use of a brisk *Tesla* Effluve over the spine, with a metal electrode over the solar plexus, occasionally reversed by using the effluve over the solar plexus and the metal electrode over the base of the spine. Local affections are treated by appropriate methods in accordance with the rules given above. General *d'Arsonval* Treatments with the Condenser couch should be given frequently in this class of diseases, especially when the nutrition is impaired.

CHAPTER XXV

INFECTIOUS AND MALIGNANT DISEASES

ALTHOUGH it is true that the majority of users of High-frequency Currents are specialists who treat only chronic diseases, it is also true that the value of the currents in the treatment of acute infectious diseases is even greater than when they are applied to chronic conditions. The principal reason for the comparative rarity of High-frequency Treatment among general practitioners has been the cumbrous nature of the generating apparatus and its dependence upon the electric lighting service for its supply of energy. This objection no longer exists, as the writer has recently perfected a portable High-frequency Apparatus, which is independent of outside sources of current, its supply being drawn from a small storage battery of improved type, which is incorporated with the transforming apparatus in a portable case about a foot square.¹ (See Fig. 181.) Despite its apparent insignificance when compared, for example, with the writer's Hercules Machine, this little instrument has thoroughly demonstrated its remarkable therapeutic possibilities. During the past year a number of these little machines have been in use being especially adapted for installation in the homes of bed-ridden patients. Their technic and adjustments are simple, and daily treatments may be given by the nurse or attendant under the instruction and occasional supervision of the physician in charge. Not only local conditions, such as diseases of the skin and septic areas, but chronic constitutional diseases, such as rheumatism, arthritis, and organic affections of the heart, have been successfully treated by this little device. Up to the present time this instrument has been constructed for the writer's use, for installation in the homes of patients, who are unable to

¹“Columbia Dry Cells,” such as are commonly used in automobiles, can be employed with this machine if desired. Six of these cells will run the apparatus for approximately fifty treatments, at a total cost of \$1.25.

come to his office for treatment. The apparatus has been made in the writer's private laboratory under his personal supervision.

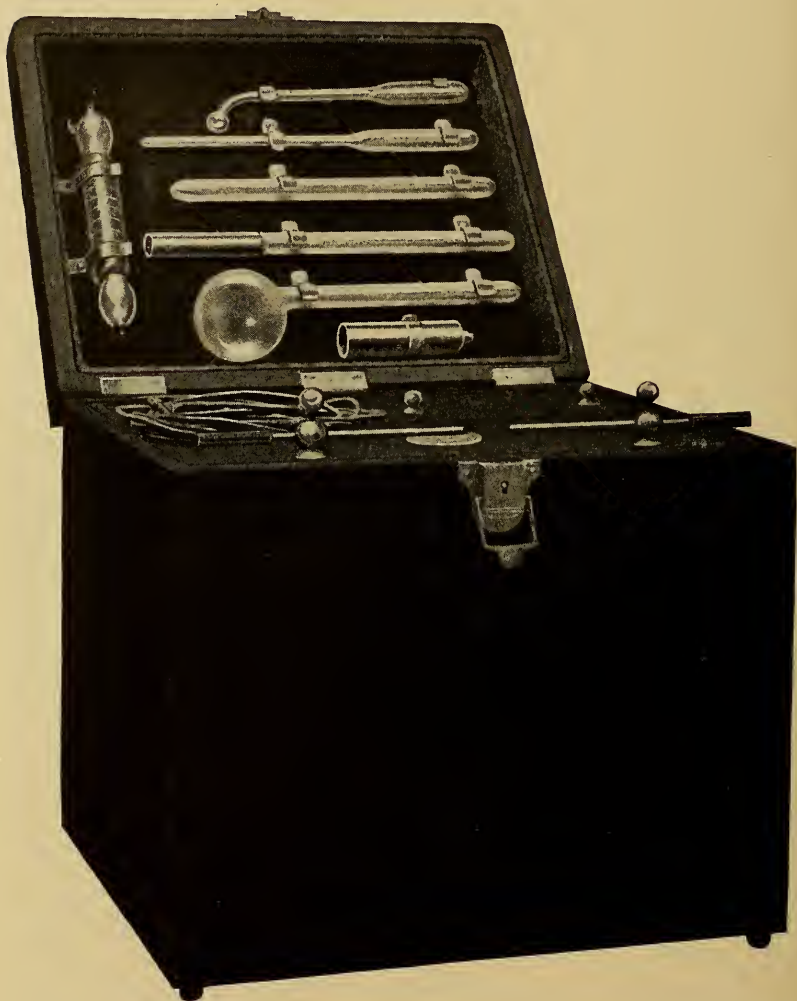

FIG. 181.—The Author's Portable High-frequency Apparatus Operated by Current from Its Own Battery.

It will undoubtedly be placed upon the market, and meanwhile the writer will gladly furnish any information regarding its construction and uses to physicians who may be interested in the subject.

Prompt *Tesla* Treatment with the effluve applied alternately to the spine and solar plexus, followed by a general application of the High-frequency Wave Current, will actually abort many varieties of acute infectious disease if administered sufficiently early in the course of the attack. In the prodromal stage, and the period of incubation, treatments should be given twice daily. In the acute stage, with chills, fever, headache, nausea, etc., fifteen-minute treatments should be given at intervals of thirty minutes until the fever subsides, and the patient breaks out in perspiration. For the above purpose, a heavy current is usually necessary, such as that produced by the writer's Ajax, or Hercules Machine. Nevertheless, in several instances acute infections such as La Grippe, have been successfully aborted by the persistent application of currents from the little portable apparatus above described.

Septic areas or the local lesions of infectious diseases, whether superficial or subcutaneous, readily yield to prompt treatment



FIG. 182.—The Author's Localizing Effluve Electrode for Treating Ulcers and Septic Areas.

with the *Tesla* Currents. Ulcerated areas should be treated with the *Tesla* Effluve from a fine metal brush electrode; if the mucous membrane be the seat of the lesion, the effluve may be localized by the use of a metal brush inside of an insulating glass tube, open at the end (see Fig. 182). This electrode was first employed by the writer in 1897; shortly afterward a device of almost identical construction was placed upon the market by a Paris manufacturer under the title of "Bisserie's Brush Electrode."

Lesions which do not involve ulceration or solution of surface continuity may be treated with the Red-vacuum Electrode. This applies to almost all of the local acute diseases of the skin and mucous membrane, of bacterial or parasitic origin. The subcutaneous areas of infection, including abscess formations, in the early stage of congestion and stasis, the Red-vacuum Condenser Electrode should be employed, with the *Tesla* Technic;

in later stages, involving active suppuration, the White-vacuum electrodes should be employed. In severe cases of mastoid abscess with cerebral and pyæmic symptoms, a vigorous thirty-minute treatment with the White-vacuum electrode applied externally, and a metal electrode in the mouth of the patient, produced an absolute dispersion of the acute manifestations, the patient sleeping naturally inside of five hours. The next day the pus was withdrawn, and although cover-glass preparations showed countless members of streptococci and staphylococci, but a few scattered colonies were obtained in a plate-culture on nutrient gelatin.

Cervical adenitis and tuberculosis of the lymphatic glands have been successfully treated by the above method, which is also applicable to almost any type of sub-acute inflammation accompanied by hyperplasia. Diseases of the skin of a sub-acute or chronic character resulting from, or associated with diseases of the digestive system, or derangements of the nutrition are almost without exception amenable to High-frequency Treatment. Eczema, acne, psoriasis, alopecia, seborrhea, etc., have been repeatedly cured by well-known practitioners, most of whom have employed the direct effluve and vacuum treatment, in some instances supplemented by the use of the X-Ray or the Ultra-violet Ray from a *Piffard* Lamp. The writer has employed, in the above conditions, both Red- and White-vacuum electrodes; the latter giving the best results in chronic conditions, the former in lesions of the acute congestive type. The *Tesla* Technic appears to be more efficient, than the direct monopolar treatment. In obstinate cases which do not yield to the latter methods, the X-Ray Condenser Electrode will often prove efficacious. In superficial malignant conditions as epithelioma, lupus, rodent ulcer, etc., the treatment with the X-Ray electrode should be supplemented by the *Tesla* Effluve and in obstinate, refractory, conditions, by the High Ultra-violet Rays from a lamp with iron electrodes, operated by the condenser discharge from a *Tesla* Apparatus. Malignant disease of the mucous cavities should be treated on similar lines, with electrodes exhausted to an X-Ray vacuum. Epithelioma of the cervix uteri may be successfully treated by the special double

vacuum method, recently devised by the writer, which has been described in a previous chapter. Cancer of the body of the uterus may be similarly treated, substituting an X-Ray Condenser Electrode for the Low Red-vacuum Electrode, which is applied to the supra-pubic region.

CHAPTER XXVI

SPECIAL USES FOR CURRENTS OF HIGH-FREQUENCY

IN the preceding chapters the writer has attempted to describe the methods for the application of High-frequency Currents in the more prominent general and local diseases. Few cases have been cited illustrating the successful use of the different methods in the various types of disease, but in every instance in which the technic for the treatment of a given affection is described, corresponding cures have been effected, either in the writer's own practice or in the experience of some other recognized authority.

The therapeutic use of High-frequency Currents is based upon physiological effects of such a fundamental character, and the rules for the use of the different High-frequency Modalities are so broad and simple that a detailed description of the technic of treatment of the general and local symptoms in the course of an ordinary "cold," (or acute coryza), is in reality a complete guide to the physician in the use of these currents in practically all varieties of local and general disease. The vitalizing and invigorating effects of High-frequency Treatment are necessarily beneficial in *all diseased conditions*; and *special* effects, resulting from the various modifications of technic, are secondary to the fundamental action of the High-frequency Oscillations.

There are many diseases which have been effectually treated by High-frequency Currents of which no especial mention has been made in the present volume. From a consideration of the technic for the treatment of the typical examples of the different classes of diseases, herein described, the physician may obtain an intelligent idea of the methods which should be adopted in the treatment of any particular disease which has not been mentioned by the author.

The use of High-frequency Currents in the various medical "*Specialties*," is in itself a broad subject for consideration.

Cases have been reported in which various diseases of the eye and ear have been successfully treated with High-frequency Currents; for example, trachoma, granular lids, glaucoma, cataracts, ptosis, exophoria, and incipient optic neuritis, also otitis-media, tinnitus, aural catarrh, Eustachian inflammation and stricture, and various affections of the inner ear and acoustic nerve.

Similarly a fairly large treatise might be written concerning the practical uses of the High-frequency Currents in dentistry. Actual anæsthesia during extraction of teeth has been successfully induced by the use of *Tesla* Currents, double vacuum electrodes being used, one against the gum, the other on the skin over the dental nerve.

Pyrrhœa aveolaris has been treated with exceptional success by the *Tesla* Currents; a special set of vacuum electrodes has been devised for the treatment of this disease. (See Fig. 183.)

The little portable apparatus designed by the writer, and described in the preceding chapter, is especially adapted for dental High-frequency work.

The lack of system and coördination in the clinical reports of cases treated by High-frequency Currents, more especially those which have appeared in the various medical journals in America during the past five years, has rendered it well-nigh impossible to draw reliable conclusions in regard to the absolute and relative value of the different methods for the generation and application of High-frequency Currents in the treatment of disease.

Statements appearing in the present volume regarding the therapeutic action of these currents are based mainly upon the writer's personal experience, but in no instance has he made any definite statement as to the value of any special method in relation to a particular disease unless the results of his own clinical experience had been confirmed by one or more reliable authorities.

With a view to the ultimate production of a thoroughly reliable "Clinical Manual" compiled from the records of a large number of practitioners who employ High-frequency Currents in their practice, the writer has prepared a blank form (a sample of which will be found in each copy of this book), for the systematic

record of cases treated with High-frequency Currents between the present time and January, 1910. In the interests of humanity and of the profession at large, the author urgently requests every reader of this book who is a practitioner of electro-therapeutics to record his cases on forms of this description and

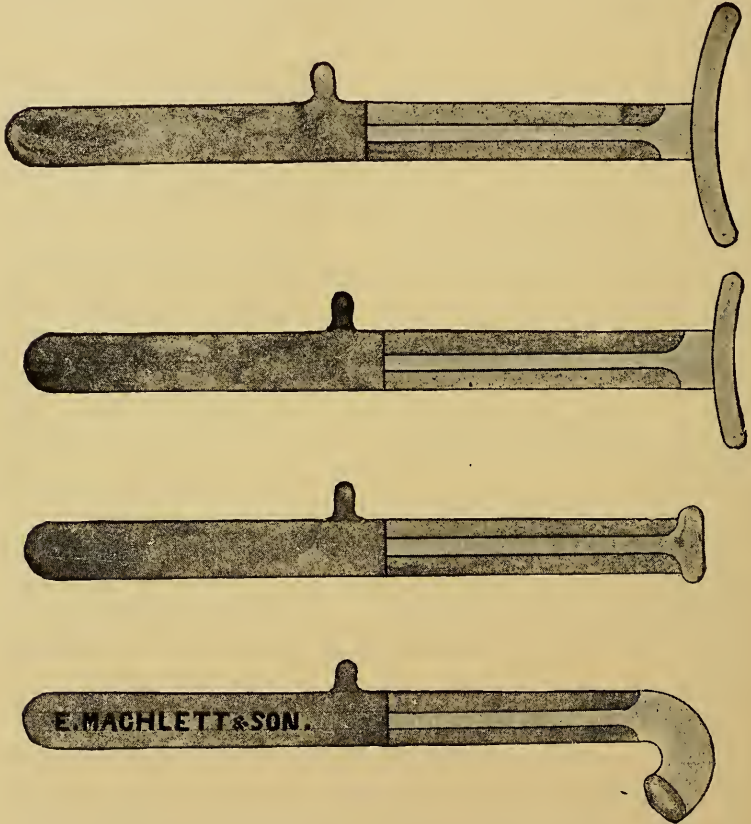

FIG. 183.—Vacuum Electrodes for Treatment of Pyrrhoea Alveolaris.

forward them to him in care of the publishers (*The Rebman Company, New York*). Extra blanks for records may be obtained on application. It is the author's intention to prepare a clinical manual compiled from these reports. The book will form a sort of sequel to the present volume and due acknowledgment will be made of the assistance rendered by the physicians who may have submitted clinical reports.

INDEX

INDEX

- Abscesses, treatment of, 277
 Active congestion, 254
 Acute coryza, 256
 Adrenalin, de-hematization by, 203
 Air-gap condenser terminals, 15, 138
 Air pressure, effects of on discharge, 178
 Air-jacket insulation for vacuum electrodes, 181
 Ajax High-frequency Coil, 106, 108
 Alternator, Tesla's High-frequency, 41
 Alternating currents, 36
 Alternating type, High-frequency Apparatus, 73, 88
 Alternations, 40
 Amperes, 38
 Anode, 33
 Analysis of High-frequency Currents, 124
 Analogy, study by, 46
 Analogy between Sound-waves and High-frequency Currents, 52
 Anæmia, treatment of, 254
 Anti-toxins, 212
 Appendicitis, treatment of, 251
 Arc, High-frequency, 138
 Arc, High-frequency, effect on bacteria, 236
 Arc, High-frequency, use of for cautery, 232
 Arcing, prevention of, 99
 Arrangement for producing Oudin-d'Arsonval Currents, 126
 Arrangement for producing Tesla-Thomson Currents, 127
 Arteriosclerosis, 255
 Auto-condensation, 7, 158
 Auto-condensation with currents from Tesla Coil, 168
 Auto-conduction, 6, 157
 Autograph of High-frequency Discharge, 147

 Batteries, 38
 Bipolar methods, *see* Tesla technic, 169
 Bipolar vacuum treatment, 177
 Bisserie's Electrode, 277
 Bladder, diseases of, 271
 Bright's disease, 270
 Brown High-frequency Coil, 94

 Cages for Auto-condensation, 158
 Calculation of Voltage, 91
 Campbell High-frequency Coil, 95
 Capacity, 142
 relation to Frequency and Inductance, 55
 Cancer of uterus, treatment of, 278
 Carbuncles, 273
 Cardiac ganglia, 253
 Cathode rays, 190
 Cautery High-frequency, 164
 Cervical adenitis, 278
 Chart, showing author's technic, 17
 Chemical regulators for X-Ray tubes, 195
 Clinical records, 281
 Cloud-circuit Transformer, danger of using, 86
 Cole X-Ray Coil, 119
 Comparative method of study, 46
 Condenser, discharge of, 41, 43
 chair of Piffard, 160
 couch, 158
 effluve, 242
 electrodes, 181
 electrodes with graduated vacuum, 188
 Congestion, relief of, 224
 Constipation, 239
 Continuous current, 38
 Corpuscle, *see* Electron, 19
 Crookes' tubes, 190
 Cushion, spiral, 159
 Cycle of frequency, 40
 Cyclone coil, 97
 Cymometer, 153
 Cystitis, 271

 D'Arsonval, early experiments of, 4
 Auto-conduction cage of, 6
 High-frequency Currents of, 41
 High-frequency Currents of, direct application of, 155
 High-frequency Currents of, generation of, from author's apparatus, 85
 High-frequency Currents of, technic of application, 155, 228
 High-frequency Currents of, therapeutic effects of, 227

- Deafness, treatment of, by High-frequency Currents, 281
- Definition of High-frequency Current, 93
- Deflection of Cathode rays by magnet, 191
- Dentistry, uses of High-frequency Currents in, 281
- Diamond, transparency of, to X-Ray, 191
- Dipper Mercury Interrupter, 63
- Direct current types of High-frequency Apparatus, 114
- Dosage, measurement, 149
- Double Focus tube, 197
- Double resonator treatment, 243
- Double vacuum treatment, 186
 - effects of, 241
- Ducretet's small Tesla apparatus, 7
- "Dynamic Thought," 25
- Dynamos, 39
- Dyspepsia, treatment of, 225

- Ebonite Spinal Electrode, 183
- Effluve, 99, 141
 - electrodes, 163
 - technic, 162
 - effects of, 231
- Electrical charges, nature of, 30
- Electro-dynamic phenomena of High-frequency Currents, 142
- Electrolytic break, 64
- Electro-magnetic Theory of Light, *see* Maxwell's Theory, 35
- Electrons, 19
 - motions of, 31, 34
 - speed of, 191
 - theory of, 20
- Electro-physics, 30
- Electro-static phenomena of High-frequency Currents, 135
- Epilepsy, treatment of, 274
- Ether waves, 35
- European types of High-frequency Apparatus, 58
- "Ewald-Boas" Test Meal, 250
- "Extra current," 61

- Factors determining qualities of High-frequency Currents, 125
- Faradism; 2
- Fever, treatment of, 277
- Finsen's Light Treatment, 201
- Flemming's Cymometer, 153
- Fluorescence, 179, 204
- Foods, classes of, 249
- Formula for determining effects of resistance on condenser discharges, 56
- Franklin, work of, 3
- Frequency, 40
 - effect of inductance on, 55
- Frequency, therapeutic effects of change of, 92.
 - of the nerve currents, 210
- Freund's experiments, 236
- Friedländer's vacuum condenser chair, 187

- Galvanic current, 216
- Galvani's discovery, 2
- Gaiffe's heavy solenoid and oil condenser, 71
 - bipolar resonator, 72
 - "closed-circuit transformer" apparatus, 73
- Generation of High-frequency Currents, 46
- Generators, 38, 39
- Germicidal action of High-frequency Currents, 222
- "Geryk" air-pump, 177
- Glass plates, penetration of, by High-frequency Currents, 146
 - effects of treatment by, 233
 - electrodes, 175
- Gleet, treatment of, 271
- Gonorrheal infection, treatment of, 271
- Graphic tracing of alternating current, 37

- "Hard" X-Ray tubes, 193
- Headache, High-frequency treatment for, 274
- Heat produced by High-frequency Discharge, 140
- Heinze X-Ray and High-frequency Apparatus, 120
- Hemorrhoids, treatment of, 252
- "Hercules" High-frequency Apparatus, 107, 110, 121
- Herschell's regulating handle, 182
 - treatment of digestive diseases 251.
- Hertzian waves, methods of neutralizing, 74
- Hertz resonator, 3
- "High-frequency Wave Current," 244
 - cautery current, 164
 - currents as energy carriers, 221
 - transformer, construction of, 110
- History of physical therapeutics, 1
- Hot-wire mil-ammeter, 149
- Hydraulic analogue, of continuous current, 36
 - alternating, 37
 - electrical oscillations, 43
 - illustrating Ohms law, 46
 - of d'Arsonval High-frequency Current, 48
 - of Tesla-Thomson High-frequency Current, 49
- Hyperstatic transformer, 12, 247
- Hysteria, treatment of, 274

- Immunity of human body to High-frequency Currents, 133
- Impotence, functional, treatment of, 271
- Indirect spark, technic for use of, 170
- Indirect vacuum treatment, 235, 237
- Inductance, 41
- Induction coil, 39
- Induction, phenomena of, 133
- Inductive resistance, *see* Inductance, 41
- Inducto-resonator, 117
- Infectious diseases, treatment of, 275
- Inhibitory effect of High-frequency Currents, 222
- Insulation of Tesla Coils, 85
- Insulators, penetrability of, 57, 86
- Intensity, unit of, *see* Ampere, 38
- Interrupter, Wehnelt (Electrolytic), 58
mercury jet, 61
- Ionization of spark-gap, 174
- Iron wire, burning of, by High-frequency Currents, 140
- Isenthal-Kohl X-Ray and High-frequency Apparatus, 81
- Jackson Coil, 101
frequency of, 91
spark-gap of, 102
- Kinetic energy, 38
- Kinraide's Coil, construction of, 89
High-frequency Spirals of, 90
relative frequency of, 91
- Kinraide's early X-Ray work, 14
- Knott High-frequency Apparatus, 14, 83
- Labile applications, 156, 229
- Lamp-bulb electrode, 151
- Law of transformation, 91
- Leather-covered glass electrode, 233
- Lenard's cathode rays, 190
- Leucocytes, function of, 210
- Leyden jar, 3
- Life principle, 28
- Lodge's analogue, 54
- Low-frequency effects from Tesla Apparatus, 167
- Mackenzie-Davidson Interrupter, 63
- Magnetic deflection of moving electrons, 191
- Magnetic induction, 34
- Magnetism, theory of, 33
- Malignant disease, treatment of, 275
- Maxwell's Theory of Light, 35
- Measurement of High-frequency Currents, 149
- Mendeleeff, Periodic Law of, 21
- Mercury vapor in vacuum lamp, 234
- Meyrowitz High-frequency Apparatus, 118
- Modern therapeutic methods, review of, 209
- Molecular bombardment by effluve, 141
- Monopolar treatment, 230
- Morton's "Static Induced Current," 3, 57
- Motor, Tesla's High-frequency, 144
-impulse Current, the author's, 172
-wave Current, the author's, 170
- "Multi-frequency Currents," 167, 230, 243
- Muscular affections, treatment of, 93
- Negative Ions, 32
- Neon tube, 154
- Nephritis, 270
- Nervous dyspepsia, treatment of, 225
- Neuralgia, 176
- Neuritis, treatment of, 273
- Neuroses, functional, 273
- Neutral atoms, 32
- Nitrogen, oxides of, 205
- Nodon valve, 59
- Ohm, 38
- Ohm's law, 38
- Oil-insulation, 42
- Opacity of bodies to ultra-violet rays, 203
- Organic compounds, 28
- Oscillations, electrical, 3, 40, 42
- Osmotic regulator, 195
- Oudin resonator, 9, 65
methods of tuning, 69
technic for use of, 161
- Ozone generation of, by High-frequency Currents, 205
- Palladium regulator for X-Ray tubes, 196
- Paralysis, 273
- Passive congestion, 252
- Penetrability of matter by X-Rays, 192
- Phenomena of High-frequency Currents, 132
- Phosphorescence, 204
- Photometric mil-ammeter, 152
- Physical properties of High-frequency Currents, 132
- Physiological action of High-frequency Currents, 221
- Piffard's "Hyperstatic" transformer, 12, 92
spark-gap lamp, 202
- Plate condensers, 41
- Pneumogastric nerve, 253
- Pneumonia, treatment of, 254
- Portable High-frequency Apparatus, 275
- Positive Ions, 32
- Potential, unit of, *see* Volt, 37

- "Pseudo-static" spark, 139, 232
 -Faradic Current, 245
 Pulsatory currents, 57

 Quartz lens for transmitting ultra-violet rays, 179

 Radiant energy, 23, 35
 Radium, formation and decomposition of, 20, 22
 Rectifying valve, *see* Nodon valve, 59
 Rectum, diseases of, 252
 Red vacuum, 189
 Regulating handle for vacuum electrodes, 182
 Renal congestion, 270
 colic, 270
 Requisites for an efficient High-frequency Apparatus, 99
 Resistance, unit of, *see* "Ohm." 38
 effect of, on condenser discharge, 56
 Resonator, Oudin's, 41
 discharge of, 41
 Hertz, 3
 technic, 161
 Roentgen's discovery, 190
 Rotary converter, 60, 115
 Rowland's experiments, 4
 Ruhmkorff type of High-frequency Apparatus, American forms of, 116, 119
 coil, 39, 60
 Rhythmic effluve treatment, 239

 Scheidel-Western X-Ray and High-frequency Apparatus, 116
 Self-regulating X-Ray tubes, 197
 Septic areas, treatment of, 277
 Single-focus X-Ray tube, 197
 Sinusoidal current, 130
 from Tesla Apparatus, 171
 Skin diseases, High-frequency treatment for, 93
 Sodium atom, 34
 "Soft" X-Ray tubes, 193
 Solenoid, of d'Arsonval, 4, 45
 Sound waves, carried by High-frequency Current, 174
 Snow's set of vacuum electrodes, 180
 Spark-gap, breaking down resistance of, 51
 analogy to elastic diaphragm, 50
 Spark-gap, rotary, author's improved form, 112
 Spark-gaps, various forms of, 97, 102
 Special uses for currents of High-frequency, 280
 Spectrum of iron, 202
 Spotteswoode coil, 4
 "Stabile" applications, 156, 228

 Static machine, High-frequency Current derived from, 92
 "Static Modalities," 216, 220
 "Step-up" Transformer, 41, 60
 Stricture of urethra, treatment of, 271
 "Strong-Ovington" High-frequency Apparatus, 82
 Superimposed waves, 167
 Systems of therapeutics, 213

 Table of wave lengths and frequencies, 24, 25
 Technic, author's system of, 15
 Technic for use of condenser electrodes, 182
 Tesla, early experiments of, 4
 currents, methods of applying, 166
 early apparatus of, 42
 effluve, 168
 spark, 170
 technic, 238
 vacuum treatment, 176
 Tesla-Thomson Coils, early American form of, 88
 diagram, showing construction of, 90
 modern American forms of, 106
 Tetanus, cause of spasms in, 211
 "Theater Plug," for regulating current strength, 109
 Theories of Matter and Force, 19-20
 Therapeutic technic, 55
 action of High-frequency Currents, 226
 Thermo-faradic coil, 105
 current, 160
 Thiele's, treatment of Tuberculosis, 261
 Thomson, Professor Elihu, Giant High-frequency Current of, 4
 double-focus X-Ray tube, 197
 High-frequency Coil of, 41
 Tracing, showing nature of High-frequency Wave Current, 122
 Trans-resonator Technic, Piffard's, 247
 electrode, Piffard's, 247
 Triple terminals, the author's, 15, 138
 Trophic nerve influence, 224
 Tuberculosis, author's apparatus for treatment of, 206
 Tyrell's "Cascade," for flushing the colon, 252

 Ultra-violet lamp, the author's, 202
 Ultra-violet Rays, 179
 generation of by High-frequency Currents, 201
 physiological effects of, 203
 therapeutic effects of, 201, 203
 Universal X-Ray tube, 200
 Uranium, formation of radium from, 22
 Urethral stricture, treatment of, 271

- Vagus, *see* Pneumogastric Nerve, 253
- Vacuum condenser chair, 168
inhaler electrode, 257
regulator, 195
- Vacuum electrode, discovery of, 15
original invention of, 176
treatment by use of, 175
- Vaso-motor system, 253
- Vibratory nature of High-frequency
Currents, 52, 123, 132
- Volt, 37
- Volta, 2
- Voltaic pile, 2
- Water-cooled X-Ray tube, 194
- Waves, electro-magnetic (or "Hertzian,") 3
- "White Vacuum," 179
electrode, 189
- Williams', Chisholm, method of treatment in nervous Dyspepsia, 251
treatment of pulmonary tuberculosis, 257
- Wireless telegraphy, 3
use of High-frequency Currents in, 148
- Wöhler's synthesis of Urea, 28
- X-Rays, discovery of, 190
from vacuum electrodes, 235
generation of, from High-frequency Currents, 101, 190
tubes for, with High-frequency Apparatus, 195
- Yellow phosphorescence, 204
- "Zone of Stasis." broken up by High-frequency Currents, 233

COUNTWAY LIBRARY OF MEDICINE

QC

601

S88

RARE BOOKS DEPARTMENT

